

At Transtar, we are committed to bring you the products and services you need to help your business thrive. With our enhanced product line, increased inventory, and more local distribution centers, we are even better equipped to provide you the parts you need, when you need them.

CATALOG STRUCTURE

The Transtar Catalog is organized in the following manner:

White Pages

Domestic Transmissions

- **General Motors**
- **Ford**
- **Chrysler**

Tan Pages

Imported Transmissions

Orange Pages

- **Hi Performance Kits & Components**
- **Transfer Case Gaskets**
- **Detent Cable Assemblies & Repair Kits**
- **Diagnostic Equipment**
- **Additives**
- **Special Service Items**

Printed in the U.S.A. Copyright © 1979, 1982, 1984, 1986, 1988, 1990, 1993, 1995, 1997, 1999, 2000, 2002, 2004, 2006, 2008. Editions by Transtar Industries, Inc., 7350 Young Drive, Cleveland, Ohio, 44146, U.S.A. All rights reserved. No part of this publication may be reproduced, stored in a retrieval system, or transmitted, in any form, by any means, electronic, mechanical, photocopying, recording, or otherwise, without prior written permission of Transtar Industries, Inc. Transtar Industries acknowledges that many of the illustrations in this catalog were inspired by photographs originally published by Slauson Transmission Parts and that Slauson is the owner of the copyright in those photographs.



THE TRANSTAR PART NUMBERING SYSTEM

The new Transtar part numbering system is very easy to use. The part number is based on a **prefix**, **base number**, and **suffix**, that, when broken down, will tell you the almost everything you need to know about the part.

Prefix Letters refer to various part differences, such as the part's origin. Here are some examples of prefix letters and their meanings (although prefixes may differ between product groups):

A	Aftermarket New
B	Borg Warner Brand
C	Core
D	Original Equipment
N	New
P	Premium Parts
R	Remanufactured Hard Parts (Previously AR)

The **Base Number** is made up of two components, beginning with a two or three-digit number that tells you the Transmission Type. You can see the Transmission Type in the Table of Contents on pages three and four of this catalog. For example, "14" is the Transmission Type for an 4T40E. The Transmission Type is also located on the Illustration page, or exploded view, of each transmission.

The next three digits refer to the product group. The numbers "500" for example, tell you that the part is a pump. (For the complete list of product group numbers, please see the "Part Numbering Guide" on our website.)

Suffix Letters refer to part differences, such as its design level or material composition. Here are some examples of suffix letters and their meanings (although suffixes may differ between product groups):

F	Fiber Pan Gaskets
HD	Heavy Duty
HP	High Performance
K	Parts in Kit Form

PAGES

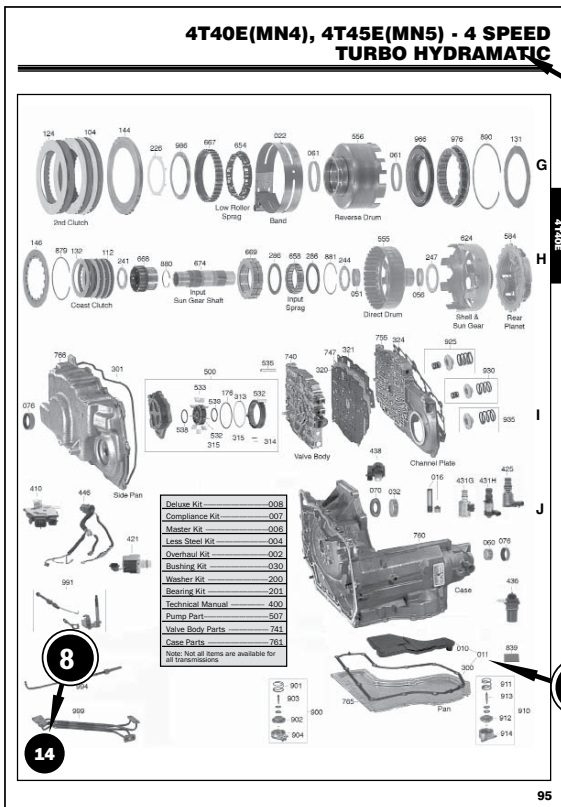

1. Illustration Number
2. Product Description
3. Quantity used in a standard rebuild
4. Year Coverage
5. Transtar Part Number
6. Reference Number (original Transtar Part Number)*
7. Transmission Name
8. Transmission Type

*please note that this is not the OE Number, as in previous catalogs

ILL.	DESCRIPTION	QTY	YEAR	PART NO.	REFERENCE
4T40E(MN4), 4T45E(MN5) - 4 SPEED TURBO HYDRAMATIC					
DELUXE KITS (SUPER KITS)					
006J	4T40E, 4T45E (w/ Bonded Pistons)	1	95-Up	14008APW	K3600-R
COMPLIANT KITS (CALIFORNIA KITS)					
007J	4T40E, 4T45E (w/ Bonded Pistons)	1	95-Up	14007APW	CK3600S-R
MASTER OVERHAUL KITS (WITH STEELS)					
006J	4T40E, 4T45E (w/ Bonded Pistons)	1	95-Up	14006APW	K3600
LESS STEEL KITS					
004J	4T40E, 4T45E (w/ Bonded Pistons)	1	95-Up	14004APW	K3600-LS
OVERHAUL KITS (W/ RINGS & SEALS)					
002J	4T40E, 4T45E (w/o Bonded Pistons)	1	95-Up	14002AW	K36900
002J	4T40E, 4T45E (w/ Bonded Pistons)	1	95-Up	14002APW	K36900M
FILTER KITS					
011K	Filter Kit	1	95-Up	14011AW	FK36710
FILTERS					
010K	Filter	1	95-Up		36710
016J	Screen, Shift Solenoid (Snaps in Separator Plate)	1	95-Up		61713A
016J	Screen, Actuator Feed (in Valve Body)	1	95-Up		36712

TABLE OF CONTENTS

TRANSMISSION	SERIES	PAGE
GENERAL MOTORS		
125, 125C.....	64000	6
180, 180C.....	24000	16
200, 200C.....	54000	26
200-4R.....	54000	24
325, 325-4L.....	54000	34
350, 350C (250, 250C).....	44000	36
400.....	34000	44
440-T4 (4T60).....	84000	102
700-R4 (4L60).....	74000	60
4L30E.....	24000	16
4L40E.....	134000	54
4L60E,4L65E.....	74000	60
4L80E, 4L85E.....	34000	78
4T40E, 4T45E.....	14000	94
4T60E, 4T65E.....	84000	112
4T80E.....	94000	126
5L40E, 5L50E, 4L40E.....	134000	54
6L45, 6L50, 6L80E.....	104000	88
6T70, 6T75 (6F50, 6F55).....	124000	134
Aveo (AW80/81-40LE).....	199000	142
Aluminum Powerglide.....	114000	146
Saturn TAAT.....	10000	138
MK2, MH5 (Doug Nash).....	194000	77
Allison LCT 1000.....	121000	148
Allison AT540.....	111000	154
Allison MT640.....	101000	160
AF40 (TF-80SC) GM, Volvo.....	39000	286
FORD		
C-3.....	56000	174
A4LD.....	56000	174
4R44E, 4R55E, 5R55E.....	56000	184
5R55N, 5R55S, 5R55W.....	46000	194
C-4, C-5.....	26000	202
C-6.....	36000	206
E40D, 4R100.....	36000	214
5R110W.....	16000	226
AOD, AODE.....	76000	232
ATX.....	66000	244
AXOD, AXODE, AX4S.....	86000	248
AX4N (4F50N).....	86000	260
CD4E.....	96000	270
FMX.....	106000	278
Small & Medium Case.....	106000	278
4F27E (FN4A-EL).....	48000	400
6F50, 6F55 (6T70, 6T75).....	124000	134
6R60 (ZF6HP26).....	95000	280
AF21 (TF-81SC).....	39000	286
CVT (Ford European).....	33000	491
CHRYSLER		
A404, 413, 470, 670.....	32000	294
A500.....	12000	300

TRANSMISSION	SERIES	PAGE
CHRYSLER (cont.)		
A518/46RE, A618/47RE, 48RE.....	22000	312
A604.....	92000	326
A606.....	62000	326
A727 (TF8).....	22000	312
A904 (TF6).....	12000	300
42RLE.....	162000	330
45RFE, 5-45RFE.....	72000	340
62TE.....	132000	346
68RFE.....	72000	340
AW/BW		
AW 450-43LE.....	49000	354
AW 50-40LE, 50-42LE (AF14-20).....	89000	358
AW 55-50SN (AF33-5).....	89000	362
AW 60-40LE (AF13).....	19000	364
AW80/81-40LE (Aveo).....	199000	142
BW T35.....	119000	324
BW T35TB, T37TB.....	149000	324
BW T65, 66.....	29000	324
Velvet Drive.....	219000	325
HONDA, ACURA		
4 Speed (2 Shaft).....	60000	368
4 Speed (3 Shaft).....	70,80,90	374
5 Speed.....	30000	384
CVT (See also Page 388).....	40000	491
MAZDA		
F3A.....	18000	405
F4A-EL (1 Pan) Escort.....	38000	394
FN4A-EL (4F27E).....	48000	400
FNR5.....	48000	400
G4A-EL (2 Pan) Probe.....	28000	406
JF404E (VW).....	83000	555
JF405E (Suzuki, Hyundai).....	83000	492
JF506E.....	98000	414
MERCEDES		
722.0, 722.1, 722.2.....	58000	418
722.3, 722.4, 722.5.....	68000	418
722.6.....	78000	424
722.9.....	88000	tba
MITSUBISHI		
KM170 - 177-8.....	42000	428
F4A32-1, A4AF-1.....	42000	428
F4A33, W4A32, W4A33.....	42000	428
F4A41, F4A42, F4A51, F5A51.....	82000	436
R4A51,V4A51, R5A51, V5A51.....	142000	440
NISSAN		
L3N71B.....	53000	444
L4N71B, N4A-EL.....	53000	444

TABLE OF CONTENTS

TRANSMISSION	SERIES	PAGE
NISSAN (cont.)		
RL3F01A, RN3F01A	43000	450
RE4F02A, RL4F02A.....	93000	454
RE4F03A, RL4F03A.....	83000	460
RE4F04A, JF403E, LJ4A-EL	83000	464
RE4R01A, RL4R01A, R4A-EL.....	73000	470
RE4R03A, RG4R01A, JR403E.....	73000	478
RE5R01A	73000	470
RE5R05A	63000	484
CVT.....	33000	491
RENAULT		
AR4, AD4, AD8	261000	490
DPO, AL4	31000	489
MB1, MJ1, MJ3.....	21000	488
4139 (18i), 4141.....	231000	488
SUBARU		
3 Speed (M41)	13000	494
4 Speed (EC8, R4AX-EL)	23000	498
5 Speed.....	63000	493
CVT.....	33000	491
SUZUKI		
JF405E.....	83000	492
TOYOTA		
A40, A40D Series	57000	504
A55.....	257000	511
MX17	67000	512
A130, A140.....	67000	512
A240.....	67000	512
A340E, A350E.....	97000	522
A440.....	137000	521
A540.....	87000	530
A650E.....	77000	536
A750E, A751F, A761E	147000	539
R150F.....	197000	524
U140, U240, U241	27000	540
U150, U151, U250	27000	546
U340, U341	37000	550
U440E, U441E.....	199000	142
U660.....	47000	553
VW/AUDI		
JF404E.....	83000	555
VW 003.....	265000	554
VW 010, 087-090	65000	556
VW 095-098, AG4.....	75000	560
09F (TF60SN).....	15000	554
CVT.....	33000	491

TRANSMISSION	SERIES	PAGE
ZF		
ZF3HP22	69000	572
ZF4HP14 Peugeot.....	79000	566
ZF4HP18 FL Premier.....	79000	566
ZF4HP18 Q Saab	79000	566
ZF4HP22, ZF4HP24	69000	572
ZF5HP18	179000	578
ZF5HP19	129000	582
ZF5HP24	139000	586
ZF5HP30	159000	590
ZF6HP19	59000	593
6R60 (ZF6HP26)	95000	280
MISCELLANEOUS		
*Table of Contents, Misc Sections		594
Advertiser List		594
Allison Governor Application Chart.....		159
Filters, Chrysler Thimble & Screens		352
Filters, Ford Thimble & Screens.....		291
Filters, GM 4L60E, 4L65E.....		76
Filters, GM Thimble & Screens.....		168
Filters, Honda		389
Filters, Mitsubishi		443
Filters, Toyota A340, A350.....		529
Filters, Toyota A40 Series		510
Honda 3 Shaft Quick Ref Guide.....		376
Honda Solenoids (Photos)		390
Honda Solenoids (Text).....		392
Honda Switches		388
Honda Vehicle Model Chart.....		390
Honda Wire Harness Repair Kits		621
Marine Transmission		325
Mercedes Band ID		423
Quick Ref Guide, Honda 3 Shaft.....		376
Speedo Gears (GM).....		170
Toyota A40 Vehicle Model Chart		510
Transfer Case Gaskets		616
Vehicle ID by Body Series		5
ZF-5HP Transmission Fluid.....		581

BODY SERIES TO VEHICLE IDENTIFICATION

GENERAL MOTORS

CODE	CHEVROLET	PONTIAC	BUICK	OLDSMOBILE	CADILLAC	CODE	CHEVROLET	PONTIAC	BUICK	OLDSMOBILE	CADILLAC
A	Celebrity	6000	Century	Cutlass Ciera		M	GEO Metro (89-Up) Sprint (89-Up)	Firefly (88-Up)			
B	Caprice Impala (to 85) Impala SS (94-Up)	Safari Wagon (to 89) Parisienne (-86)	LeSabre (to 85) Estate, Electra, LeSabre Wagon	Delta 88 (to 85) Custom Cruiser		N		Grand Am Grand Am SE	Somerset (-86) Skylark (86-Up)	Calais (85-Up) Achieva SE(90-Up)	
C			Electra (85-Up)	Ninety Eight (85-Up)	Fleetwood DeVille	P		Fiero (to 88)			
D			Electra LTD (-84) Park Ave. (-84)	Ninety Eight (to 84)	Brougham Limousine	R	Spectrum (to 89) GEO Storm (90-Up)	Sunburst			
E			Riviera	Toronado	Eldorado	S	Nova (to 88) GEO Prizm (89-Up)				
F	Camaro/Z-28	Firebird/Trans Am				T	Chevette (to 86) LeMans (88-Up)	1000 (to 87)	Opel		
G	Monte Carlo (-88) Malibu (97)	Grand Prix (-87) Bonneville (-86)	Regal (to 87)	Cutlass Supr.(-87) Cutlass Calais (-84)		U	Lumina APV (90-Up)	TransSport(90-Up)	Silhouette (90-Up)		
H		Bonneville (87-Up)	LeSabre (86-Up)	Delta 88 (86-87) 88 Royale (88-Up)		V					Allante
J	Cavalier, GEO Tracker (84-)	Sunbird	Skyhawk (to 89) (to mid-88)	Firenza (to 88)	Cimarron	W	Lumina (90-Up) Monte Carlo (95-Up)	Grand Prix (88-Up)	Regal (88-Up)	Cutlass Supreme (88-Up)	
K					Seville	X	Citation (to 85)	Phoenix (to 84)	Skylark (to 85)	Omega (to 84)	
L	Corsica, Beretta					Y	Corvette				
						Z			Reatta		

BODY SERIES

CHRYSLER

CODE	PLYMOUTH	DODGE	CHRYSLER	EAGLE	JEEP	CODE	PLYMOUTH	DODGE	CHRYSLER	EAGLE	JEEP
AA	Acclaim	Spirit	LeBaron Sedan			BR		Ram Pickup			
AB		Ram Van/ Wagon (RWD)				B1		Colt Wagon Full Size Van			
AC		Dynasty	New Yorker Landau/Salon			B2		Colt Full Size Vans		Summit	
AE	Caravelle (to 87)	600 (to 87)	New Yorker (to 87)			B3		Colt Vista (FWD, 4x4)		Summit Wagon	
AG		Daytona	Laser (to 86)			B7		Stealth			
AH		Lancer (to 89)	LeBaron (to 85) LeBaron GTS (to 89)			FJ		Avenger	Sebring Coupe Concorde		
AJ			LeBaron Coupe/ Convertible			JA	Breeze	Stratus	Cirrus		
AK	Reliant (to 89)	Aries (to 89) 600 (to 86)	LeBaron (to 89) Town & Country (to 89)			JX		Sebring Conv.			
AL	Omni (to 89) Tourismo (to 87)	Horizon (to 89) Charger (to 87)				LH		Intrepid	LHS, Concorde New Yorker	Vision	
AM	Gran Fury (to 88)	Diplomat (to 88)	Fifth Avenue (to 87) Newport (to 87)			NS	Voyager (96-Up)	Caravan (96-Up)	Town & Country (96-Up)		
AN		Dakota				PL		Neon			
AP	Sundance	Shadow				SJ					Grand Wagoneer
AQ			TC (Maserati Coupe)			SR	Viper				
AS	Voyager (to 95)	Caravan (to 95)	Town & Country (to 95)			VJ					Wrangler
AY			Imperial/ New Yorker Fifth Avenue			XJ					Cherokee/ Wagoneer
BB		Monaco		Premier		YJ					Wrangler
BD	Laser			Talon		ZJ					Grand Cherokee

OLD TO NEW TRANSMISSION IDENTIFICATION (where applicable)

OLD DESIGNATION / NEW DESIGNATION	OLD DESIGNATION /NEW DESIGNATION	OLD DESIGNATION / NEW DESIGNATION	OLD DESIGNATION / NEW DESIGNATION
GENERAL MOTORS	FORD	CHRYSLER	MITSUBISHI
TH125C.....3T40	AXODE..... AX4S	A604LD 40TE	(1992-AWD) W4A32-1
TH180C 3L30	AXODE SHO..... AX4S-HO	A604 AWD..... 41AE	(w/14 Bolt Pan)..... F4A33-1
TH180C-4 Spd Electric4L30E	AX4N.....4F50N	A606.....42LE	
TH400.....3L80	A4LD Electric 4R44E,4R55E	A61847RH	
TH400-4 Spd Electric4L80E	A4LD 5 Spd..... 5R55E	A72736RH, 37RH	
TH440-T44T60	4EAT Probe.....G4A-EL	A90430RH	
TH440-T4 Electric 4T60E	F4EAT Escort F4A-EL	A99831RH	HYUNDAI
TH475 (HD400).....3L80HD	GF4EAT 7 Solenoid Probe... GF4A-EL	A99932RH	Scoupe/AccentA4A-F1/2
TH700-R4.....4L60	4F20E Villager.....RE4F04A	AW4 JeepA340	Elantra/TiburonA4B-F1/2/3
TH700-R4 Electric.....4L60E	FN Focus.....4F27E		VOLKSWAGEN
MH1 4T80E	CHRYSLER		095/096 01M
4 Spd FWD 4T40E	A40430TH	KM171-5..... F3A21-2	097 01N
4L60E HD4L65E	A413/47031TH	KM172-5..... F3A22-A	09801P
FORD	A50040RH,42RHA	KM175-5..... F4A22-2	
AODEW..... 4R70W	51846RH	KM176-5..... F4A21-2	
4 Spd FWD.....CD4E	A60441TE	KM177-8..... F4A23-2	

TH125(M34) 3T40 TH125C(MD9) w/L/U

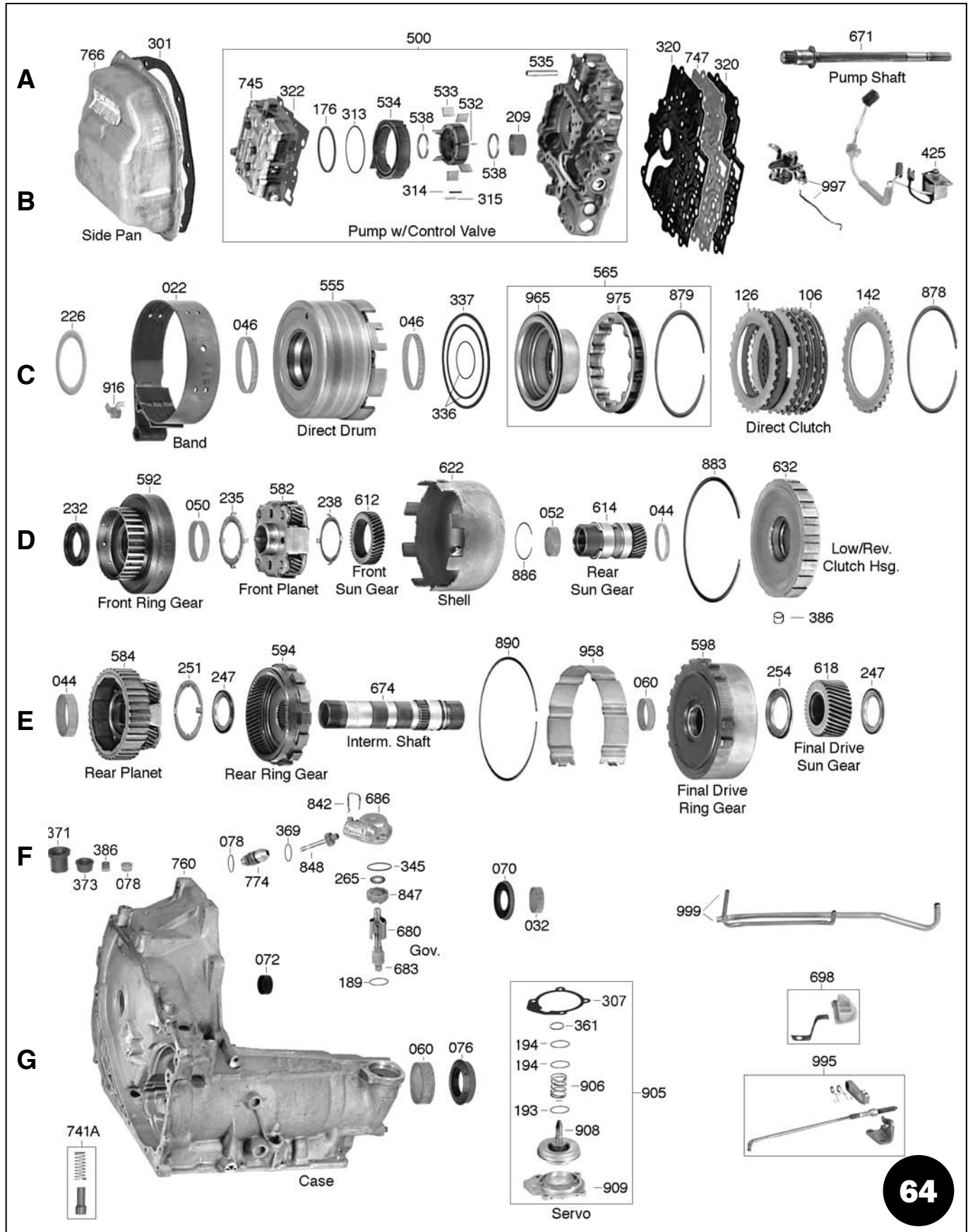

TH125(M34) 3T40 TH125C(MD9) w/L/U

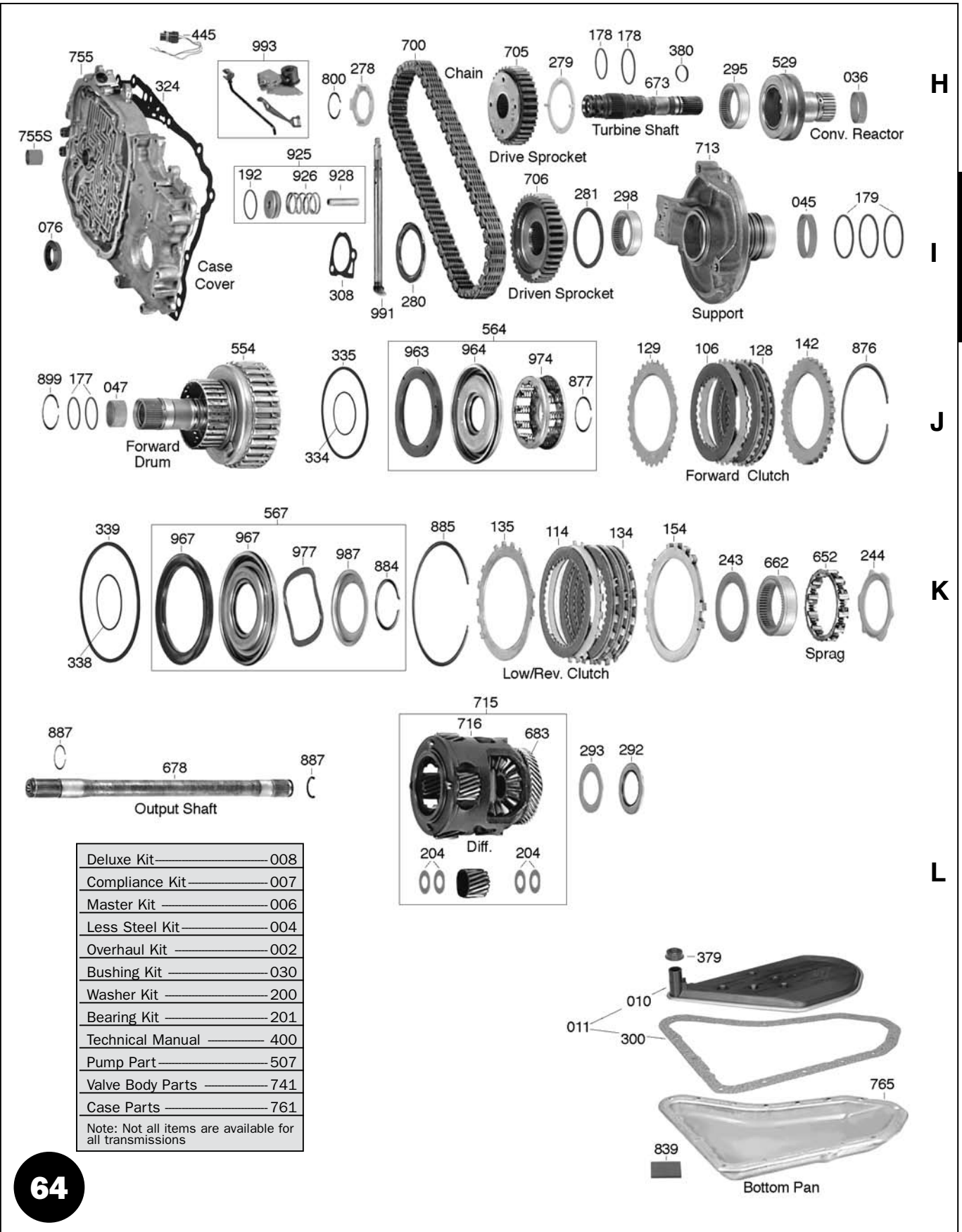

TH125(M34) 3T40 TH125C(MD9) w/L/U

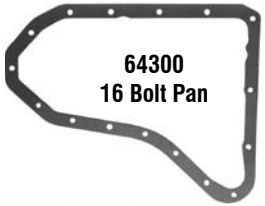

64300
16 Bolt Pan



64010

80-01 Models

BUICK	CADILLAC	CHEVROLET	OLDSMOBILE	PONTIAC	IMPORTS
Century	Cimarron	Berretta	Achieva	J2000	86-90 Holden
Skyhawk		Cavalier	Calais	6000	(Australian)
Skylark		Cadet	Cierra	Fiero	87-90 Isuzu
Somerset		Celebrity	Cutlass	Grand AM	
Opel		Citation	Firenza	Grand Prix	
		Corsica	Omega	Le Mans	
		Lumina	Silhouette	Phoenix	
		Lumina/APV		Sunbird	
				Transport	

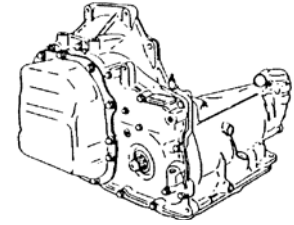

Front Wheel Drive

ILL.	DESCRIPTION	QTY.	YEAR	PART NO.	REFERENCE NO.
DELUXE KITS (SUPER KITS) (1)					
008L	125, 125C (2).....	1	80-E84	64008	K5100-R
008L	125C (3).....	1	L84-01	64008B	K5100A-R
COMPLIANCE KITS (CALIFORNIA KITS) (1)					
007L	125, 125C (2).....	1	80-E84	64007	N/A
007L	125C (3).....	1	L84-01	64007B	CK5100A-R
MASTER OVERHAUL KITS (WITH STEELS) (1)					
006L	125, 125C (2).....	1	80-E84	64006	K5100
006L	125C (3).....	1	L84-01	64006B	K5100A
LESS STEEL KITS (1)					
004L	125, 125C (2).....	1	80-E84	64004	K5100-LS
004L	125C (3).....	1	L84-01	64004B	K5100A-LS
OVERHAUL KITS (W/ RINGS & SEALS) (1)					
002L	125, 125C Combo	1	80-01	64002C	K51900C
GASKET & SEAL KITS (W/O RINGS & SEALS) (1)					
000L	125, 125C Combo	1	80-01	64000C	K51900C-1
FILTER KITS (1)					
011L	125, 125C	1	80-01	64011	FK51710A
	<i>(1) - To order Kits with Fiber pan gaskets, add an "F" suffix. (2) - uses .080" Fwd/Dir & .080" Low/Rev frictions (3) - uses .070" Fwd/Dir & .090" Low/Rev frictions</i>				
FILTERS					
010L	Main Filter	1	80-01	64010	51710A
014	Screen, Governor Screen (In Case).....	1	80-01	84014A	51711
015	Screen, Valve Body Thimble	1	80-01	64015	51712
BANDS					
Prefix Key: B = Borg Warner, A = OEM (Exc BW), N = All Other New, R = Relined					
022C	Flex (Narrow)	1	80-81	64022	51700F
022C	Flex (Wide)	1	82-93	64022A	51700G
022C	Flex (Wide) (Hi Energy)	1	94-01	64022B	51700H

TH125(M34) 3T40 TH125C(MD9) w/L/U

ILL.	DESCRIPTION	QTY.	YEAR	PART NO.	REFERENCE NO.
BUSHINGS					
030L	Bushing Kit	1	80-01	64030	K51901A
032F	Converter Hub (125)	1	80-81	64032	51005
032F	Converter Hub (125C)	1	82-01	64032B	51005A
036H	Stator Support Front	1	80-01	54036A	32006
044D	Low/ Rev Clutch Housing (Center Support)	1	80-01	64044	51011
044D	Rear Planet	1	80-01	64044	51011
045I	Driven Sprocket Support	1	80-01	64045	51004
046C	Direct Drum (Rear)	1	80-01	64046	51007
046C	Direct Drum (Front)	1	80-01	64046B	51006
047J	Input Shaft	1	80-01	64047	51008
050D	Input Gear (Front Ring Gear)	1	80-01	64050	51009
052D	Reaction Sun Gear Shaft	1	80-01	64052	51010
060E	Final Drive Gear & Case	2	80-01	64060	51013
METAL CLAD SEALS					
070F	Front	1	80-01	84070	51200AV
072F	Manual Lever (.230" Thick)	1	80-83	84072	51202
072F	Manual Lever (.350" Thick)	1	84-01	84072A	51202A
076F	Axle (Both Sides)	2	80-01	84076	51201
078F	Speed-O Shaft	1	80-01	44078X	3991LS
079	Pump Shaft	1	80-E84	64079	51203
209	Bearing w/ Seal, Pump Shaft	1	L84-01	64209A	51477A
075	Axle Stabilizer Seal	1	80-01	64075	N/A
075	Axle Stabilizer Seal (Teckpak)	1	80-01	T84075	51731BS
090	Axle Stabilizer, Right Axle (Bushing Type)	1	80-01	64090	51731S
275	Axle Stabilizer, Both Sides (Bearing Type) (Teckpak)	1	80-01	T64275	51731B
FRICTION PLATES					
106C	Forward & Direct (.080")	8	80-E84	64106	51103
106C	Forward & Direct (.070")	8-10	L84-01	64106A	51103A
114K	Low & Reverse (.080")	5	80-E84	64114	51506
114K	Low & Reverse (.090")	5	L84-01	64114A	51506A
STEEL PLATES					
126C	Direct (.090")	4	80-01	64126	51104
126C	Direct (.100") (Oversized)	AR	80-01	64126X	N/A
128J	Forward (Flat)	3-4	80-01	64128	51100
129J	Forward (Waved)	1-2	80-01	64129	51105
134K	Low & Reverse (.080")	5	80-E84	64134	51101
134K	Low & Reverse (.088")	4	L84-01	64134A	51101B
135K	Low & Reverse (.078") (Waved)	1-2	82-01	64135A	51101A
N.I.	Steel Module	1	L84-01	64139B	N/A
PRESSURE PLATES					
Prefix Key: D = OEM, A = Aftermarket New, R = Remanufactured					
142C	Forward & Direct (.130")	1	85-01	64142D	51714E
142C	Forward & Direct (.150")	1	85-01	64142C	DK51552
142C	Forward & Direct (.170")	1	85-01	64142B	51714G
142C	Forward & Direct (.190")	1	80-01	84148	51714
142C	Forward & Direct (.193")	1	85-01	64142A	51714D
142C	Forward & Direct (.210")	1	80-01	64142AC	51714B
154K	Low & Reverse	1	80-01	64154	N/A

TH125/125C

TH125(M34) 3T40

TH125C(MD9) w/L/U

ILL.	DESCRIPTION	QTY.	YEAR	PART NO.	REFERENCE NO.
VALVE BODY RECALIBRATION KITS					
165L	Shift Kit®, 125/125C, Corrects/ Prevents 3-2 Clunk (Transgo®)	1	80-01	T64165	K51908
165L	Valve Body Kit (Superior).....	1	80-01	S64165	51C01
SEALING RINGS					
175L	Ring Kit (Metal)	1	80-01	64175	K51903A
175L	Ring Kit (Teflon)	1	80-01	64175T	K51903T
178H	Turbine Shaft (Front) (Solid)	1	82-01	64178AT	N/A
178H	Turbine Shaft (Rear) (Solid).....	2	82-01	64178BT	N/A
189F	Governor Pin.....	1	80-01	54189BT	N/A
THRUST WASHERS					
200L	Washer Kit (No Bearings or Selective Washers)	1	80-01	64200	K51907
226C	Direct Drum to Support.....	1	80-01	64226	51429
232D	Forward Drum to Hub 1.220" ID (Plastic)	1	80-87	64232	51473
232D	Forward Drum to Hub 1.270" ID (Brass).....	1	87-01	64232A	51473B
235D	Front Planet to Hub.....	1	80-01	64235	51463
238D	Front Planet to Sun Gear.....	1	80-01	64238	51462
244K	Sprag to Rear Planet	1	80-01	64244	51427
251E	Rear Planet to Rear Ring Gear	1	80-01	54251A	32409
265F	Governor to Cover.....	1	80-01	64265	51466
278H	Drive Sprocket to Cover.....	1	80-01	64278	51412
279H	Drive Sprocket to Support (86-01)	1	86-01	64279A	51413
281I	Driven Sprocket Rear (82-01).....	1	82-01	64281A	51438
N.I.	Repair Kit, Front Planet (4 Brass, 8 Steel Round, & 4 Batwing Washers).....	1	80-01	64204A	N/A
N.I.	Repair Kit, Front Planet (8 Brass Round Washers).....	1	80-01	64204AA	K51441
N.I.	Repair Kit, Rear Planet (16 Steel Washers) (Small) (.850" OD, .440" ID).....	1	80-01	64204B	K51442
N.I.	Repair Kit, Final Drive Planet (8 Brass & 8 Steel Washers) (Small) (125).....	1	80-01	64204C	K51440
N.I.	Repair Kit, Final Drive Planet (8 Brass & 8 Steel Washers) (Large) (125C).....	1	80-01	64204D	K51440A
BEARINGS					
201L	Bearing Kit	1	80-01	64201A	K51907B
209A	Pump Shaft w/o Seal.....	1	80-E84	64209	51477
209A	Pump Shaft w/ Seal	1	L84-01	64209A	51477A
247E	Rear Sun Gear & Final Drive Sun Gear (Rear)	2	80-01	54247A	32409A
254E	Final Drive Sun Gear (Front).....	1	80-01	64254	51416
280I	Case Cover to Driven Sprocket.....	1	80-01	44211C	35400C
292L	Differential to Case	1	80-01	64292	51461
295H	Inside Converter Reactor	1	80-01	64295	51486
090	Axle Stabilizer, Right Axle (Bushing Type).....	1	80-01	64090	51731S
275	Axle Stabilizer, Both Sides Bearing Type (OEM) (Teckpak)	1	80-01	T64275	51731B
275	Repair Sleeve, For 64275	1	80-01	64275S	51730
SPACERS & SHIMS					
243K	Spacer, Low/ Reverse Clutch Housing to Inner Race 1.84mm-1.94mm	1	80-01	64243B	51403B
243K	Spacer, Low/ Reverse Clutch Housing to Inner Race 2.26mm-2.36mm	1	80-01	64243C	51403C
243K	Spacer, Low/ Reverse Clutch Housing to Inner Race 2.68mm-2.78mm	1	80-01	64243D	51403D
243K	Spacer, Low/ Reverse Clutch Housing to Inner Race 3.10mm-3.20mm	1	80-01	64243E	51403E
293L	Spacer, Differential to Case 1.65mm (#2)	1	80-01	64293B	51417A
293L	Spacer, Differential to Case 1.75mm (#3)	1	80-01	64293C	51417B
293L	Spacer, Differential to Case 1.85mm (#4)	1	80-01	64293D	51417C
293L	Spacer, Differential to Case 1.95mm (#5)	1	80-01	64293E	51417D
293L	Spacer, Differential to Case 2.05mm (#6)	1	80-01	64293F	51417E
293L	Spacer, Differential to Case 2.15mm (#7)	1	80-01	64293G	51417F
293L	Spacer, Differential to Case 2.25mm (#8)	1	80-01	64293H	51417H
293L	Spacer, Differential to Case 2.35mm (#9).....	1	80-01	64293J	51417J
293L	Shim, Adjusts Rear End Play .005"	1	80-01	64293S	N/A

TH125(M34) 3T40 TH125C(MD9) w/L/U

ILL.	DESCRIPTION	QTY.	YEAR	PART NO.	REFERENCE NO.
GASKETS & O-RINGS					
300L	Gasket, Bottom Pan (Cork).....	1	80-01	64300	13990X
300L	Gasket, Bottom Pan (Fiber).....	1	80-01	64300F	13990F
301A	Gasket, Side Pan (Valve Body Cover) (Cork).....	1	80-01	64301	13991X
301A	Gasket, Side Pan (Valve Body Cover) (Fiber).....	1	80-01	64301F	13991F
307G	Gasket, Intermediate Servo Cover.....	1	80-01	64307	13763
308I	Gasket, Case Cover to Case (Small Center).....	1	80-01	64308	13752
313A	O-Ring, Pump Slide.....	1	80-01	64313	13761
314A	Seal, Pump Slide (Rubber).....	1	80-01	54314B	13768
315A	Seal, Pump Slide (Teflon).....	1	80-01	54315B	13762
320A	Gasket, Valve Body (Upper & Lower).....	2	80-01	64320	13750
322A	Gasket, Auxiliary Valve Body.....	1	82-E84	64322A	13765
322A	Gasket, Auxiliary Valve Body.....	1	L84-01	64322	13765A
322A	Gasket, Auxiliary Valve Body (Orange Stripe).....	1	87-01	64322B	13765B
322A	Gasket, Auxiliary Valve Body (Blue Stripe).....	1	88-01	64322C	13765C
324H	Gasket, Case Cover to Case (Large Outer).....	1	80-01	64324	13751
368	O-Ring, Case Connector.....	1	80-01	44369B	3410L
368	O-Ring, Speedo Sleeve.....	1	80-01	64368A	3718L
369	O-Ring, Speed-O Driven Gear Sleeve.....	1	80-85	64369	N/A
371F	Boot, Filler Tube.....	1	80-01	44371B	13925
373F	O-Ring, Detent Cable.....	1	80-01	54373A	3566
373F	Boot, Detent Cable.....	1	80-01	54373B	13581
379L	Filter Seal (Late).....	1	80-01	64379	13771
380H	O-Ring, Turbine Shaft O-Ring.....	1	80-01	64380	13766
382F	O-Ring, Reverse Oil Pipe O-Ring to Case.....	1	80-01	64382	13764
382F	Washer, Reverse Oil Pipe Washer to Case O-Ring.....	1	80-01	64382W	N/A
386D	Seal/Cup Plug, Low/ Reverse Clutch Housing.....	1	80-01	54386A	13969
386D	Seal/Cup Plug, Low/ Reverse Clutch Housing (Updated, Long).....	1	80-01	64386B	13969A
TECHNICAL MANUALS					
400L	Tech Manual.....	1	80-01	64400	51Y01
400L	Tech Manual, 125C Update / Supplement.....	1	87-01	64400H	51Y02
ELECTRICAL COMPONENTS					
411	Switch, 2nd Clutch Pressure (3 Prong).....	1	87-01	64411A	15D-125
412	Switch, 3rd Clutch Pressure (2 Button).....	1	82-01	64412	15A-111
412	Switch, 3rd Clutch Pressure (1 Prong) 4.3L.....	1	82-01	54411B	15D-112
412	Switch, 3rd Clutch Pressure (1 Button Prong).....	1	89-01	64412B	15D-163
416	Switch, Governor Pressure (42-46 PSI) (2 Blade).....	1	80-01	64416AA	15A-162
416	Switch, Governor Pressure (46-50 PSI) (2 Blade).....	1	80-01	64416B	15A-250
416	Switch, Governor Pressure (50-54 PSI).....	1	80-01	64416D	15A-254
425	Solenoid (TCC) (Universal).....	1	80-01	84425	5R-148
425	Solenoid, TCC (1 Wire to Connector) (1 Spade).....	1	80-01	64425A	5A-124
425	Solenoid, TCC (2 Wire to Connector) (2 Spades).....	1	80-01	64425B	5R-126
425	Solenoid, TCC (3 Wire to Connector) (4 Spades).....	1	80-01	64425H	N/A
425	Solenoid, TCC (3 Wire to Connector) (2 Spades).....	1	80-01	64425E	5A-125
425	Solenoid, TCC (4 Wire to Round Connector) (4 Spades).....	1	80-01	64425C	5A-161
425	Solenoid, TCC (4 Wire to Square Connector) (4 Spades) (w/ Channel Retainer).....	1	80-01	64425F	N/A
425	Solenoid, TCC (4 Wire to Square Connector) (4 Spades) (No Channel Retainer).....	1	80-01	64425D	5A-153
444	Connector, Case (2 Prong).....	1	80-01	74444	25D-102
444	Connector, Case (3 Prong).....	1	80-01	74444A	25A-103
444	Connector, Case (4 Prong Round Natural Plastic).....	1	80-01	64444	25D-105
444	Connector, Case (4 Prong Square).....	1	80-01	84444	25A-104
445H	Wire Harness, External (4 Wire).....	1	80-01	64445	N/A
N.I.	Lock-Up Delay Module For Vehicle w/ Speed Sensor.....	1	80-01	LU1	30A-100
N.I.	LU1 Sensor GM Front Wheel Drive w/ Extension Cable.....	1	80-01	LU1-4226	30A-226

TH125/125C

TH125(M34) 3T40

TH125C(MD9) w/L/U

ILL.	DESCRIPTION	QTY.	YEAR	PART NO.	REFERENCE NO.
CAPSULES & CUP PLUGS					
480	Capsule w/ Check Ball, Various GM Drum/Stator .260" Diameter (Copper)	1	80-01	54480C	N/A
482	Capsule w/ Check Ball, Direct Drum	1	80-01	74482P	N/A
483	Cup Plug, 3RD Clutch Oil Passage .250" Diameter	1	80-01	64483D	51934
484	Cup Plug Orifice, Servo Air Bleed (w/ .004" Orifice) .250" Diameter	1	80-01	64484A	N/A
HARD PARTS					
Prefix Key: D = OEM, A = Aftermarket New, R = Remanufactured					
PUMPS & PUMP COMPONENTS					
500A	Pump w/ Valve Body (refer to the Valve Body section below)	1	80-01	N/A	N/A
209A	Bearing, Pump Shaft w/o Seal	1	80-E84	64209	51477
209A	Bearing w/ Seal, Pump Shaft	1	L84-01	64209A	51477A
314A	Seal, Pump Slide (Rubber)	1	80-01	54314B	13768
315A	Seal, Pump Slide (Teflon)	1	80-01	54315B	13762
541	Sleeve, Pump Cover Sleeve (Tin)	1	80-01	64541	N/A
529H	Converter Reactor (Stator Support)	1	80-81	64529	N/A
529H	Converter Reactor (Stator Support)	1	82-01	64529A	66985
531	Rotor Kit, 15 Spline Rotor (.708" Thick)	1	80-01	64531B	N/A
531	Rotor Kit Conversion (Converts 20 Spline to 15 Spline Rotor) (Shaft, Rotor & Vanes)	1	80-01	64531BK	N/A
532A	Rotor, 15 Spline (.708" Thick)	1	80-01	64532A	51802A
533A	Vane	7	80-01	64533	32800
533A	Vane Kit (Package of 7)	1	80-01	74533K-1	K32801
533A	Vane, Bottle of 50	1	80-01	64533-50	N/A
533A	Vane & Ring Kit	1	80-01	64533K	N/A
534A	Pump Slide	1	80-01	64534	51803A
534A	Slide & Rotor Kit (.7072")	1	80-01	64534AK	K51800A
538A	Ring, Pump Rotor to Vanes	2	80-01	64538	51308
DRUMS					
554J	Forward, w/o Check Ball	1	80-84	64554A	51926A
554J	Forward (Uses 1.220" ID Washer # 232)	1	85-86	64554B	N/A
554J	Forward (Uses 1.270" ID Washer # 232)	1	87-01	64554C	51926C
555C	Direct (2 1/4" Band Surface)	1	80-84	64555A	51928
555C	Direct (2 1/4" Band Surface) (Can Use 64555A)	1	85-01	64555B	51928A
PLANETS					
582D	Front (Input)	1	80-01	64582	51981
584E	Rear (Reaction)	1	80-01	64584	51982
592D	Ring Gear, Input Internal (Front)	1	80-01	64592	N/A
594E	Ring Gear, Reaction Internal (Rear)	1	80-01	64594	51997
598E	Ring Gear, Final Drive (Early Pawl w/ 70T)	1	83-89	84598	66935
598E	Ring Gear, Final Drive (Late Pawl w/ 70T)	1	90-01	84598B	66935B
SUN GEARS, SHELLS & SUPPORTS					
612D	Sun Gear, Input (Front Planet)	1	80-01	64612	51961
614D	Sun Gear, Reaction (Rear Planet)	1	80-01	64614	51998
618E	Sun Gear, Final Drive 30 Teeth	1	80-01	84618B	51955B
618E	Sun Gear, Final Drive 34 Teeth	1	80-01	84618A	51955A
618E	Sun Gear, Final Drive 38 Teeth	1	80-01	84618	51955
622D	Shell, Input	1	80-81	64622	N/A
622D	Shell, Input (w/ Scoops & Roll Pins)	1	82-01	64622A	N/A
622D	Shell, Input (w/ Scoops Only)	1	82-86	64622B	N/A
632D	Center Support, Low/ Reverse Clutch Housing	1	80-84	64632	51944
632D	Center Support, Low/ Reverse Clutch Housing	1	85-01	64632B	51944A

TH125(M34) 3T40 TH125C(MD9) w/L/U

ILL.	DESCRIPTION	QTY.	YEAR	PART NO.	REFERENCE NO.
SPRAGS					
652K	Sprag, Low Roller Clutch	1	80-01	64652	51503
662K	Inner Race, Low Roller Clutch.....	1	80-01	64662	51993
SHAFTS					
671A	Pump Shaft (20 Spline)	1	80-81	64671A	51969
671A	Pump Shaft (15 Spline) Conversion	1	80-81	64671AA	51969B
671A	Pump Shaft (15 Spline) (w/ Thick Steel Race on Shaft).....	1	82-E84	64671B	51969A
671A	Pump Shaft (15 Spline) (w/ Thin Steel Race on Shaft)	1	L84-01	64671C	51969C
673H	Turbine Shaft.....	1	80-81	64673	51907
673H	Turbine Shaft.....	1	82-01	64673A	51907A
674E	Sun Gear Shaft, Final Drive.....	1	82-01	64674	66943
GOVERNORS					
680F	Governor, Electronic (8 T on Pickup)	1	82-01	64680C	51910
680F	Governor, Electronic (13 T on Pickup)	1	82-01	64680A	N/A
680F	Governor, Electronic (14 T on Pickup)	1	82-01	64680B	N/A
683F	Gear, Governor Drive	1	80-01	64683A	N/A
CHAINS					
700H	Chain, 3/4" Wide, 42 Links	1	80-83	64700	51973
700H	Chain, 7/8" Wide, 42 Links	1	84-01	84700A	51973A
701	Chain Snubber	1	80-01	64701	51974
DRIVEN SPROCKET SUPPORTS					
713I	Support, Driven Sprocket	1	80-81	64713	N/A
713I	Support, Driven Sprocket	1	82-84	64713A	N/A
713I	Support, Driven Sprocket	1	85-01	64713B	N/A
DIFFERENTIALS					
715L	30 T Sun Gear, 20 T Pinion, 3.33 Ratio (Small .705").....	1	80-01	64715D	N/A
715L	30 T Sun Gear, 20 T Pinion, 3.33 Ratio (Large .760").....	1	80-01	84715CA	51972D
715L	34 T Sun Gear, 18 T Pinion, 3.06 Ratio (Small .705").....	1	80-01	64715C	N/A
715L	34 T Sun Gear, 18 T Pinion, 3.06 Ratio (Large .760").....	1	80-01	84715CB	51972B
715L	38 T Sun Gear, 16 T Pinion, 2.84 Ratio (Small .705").....	1	80-01	64715	N/A
715L	38 T Sun Gear, 16 T Pinion, 2.84 Ratio (Large .760").....	1	80-01	84715AB	51972C
VALVE BODIES & COMPONENTS					
740A	Valve Body w/ Pump (Premium) (3 Prong 2nd Switch Type)	1	92-01	64740-1	P51990D
740A	Valve Body w/ Pump (Premium) (Non 3 Prong 2nd Switch Type)	1	92-01	64740-2	P51990E
209A	Bearing, Pump Shaft w/o Seal	1	80-E84	64209	51477
209A	Bearing, Pump Shaft w/ Seal	1	L84-01	64209A	51477A
538A	Ring, Pump Rotor to Vanes	2	80-01	64538	51308
741L	Spring, Lock-Up.....	1	82-01	64741C-3	51935
741L	TV & Rev. Boost Valve Kit (125C) (Reduces Delayed Reverse)	1	80-01	64741RK	K51976
741L	Valve, Pressure Regulator.....	1	80-01	74507B	61964
741L	Valve, Anti-Drain Back (Valve Only).....	1	80-01	64741A	N/A
741L	Valve & Spring, Anti-Drain Back Valve.....	1	80-01	64741AK	K51965
741L	Valve Kit, 2-3 Shift w/ Spring.....	1	80-01	64741SK	K51551
741L	Valve, 3rd Accumulator Check Valve & Spring.....	1	80-01	64741S-1	51964
741L	Valve, 3rd Accumulator Check Valve & Spring (Updated).....	1	80-01	64952K	51964A
741L	Valve, Manual Valve Replacement Package	1	80-01	64741M-1	N/A

TH125/125C

TH125(M34) 3T40

TH125C(MD9) w/L/U

ILL.	DESCRIPTION	QTY.	YEAR	PART NO.	REFERENCE NO.
CASE & HOUSING COMPONENTS					
755H	Sleeve, Channel Plate Sleeve	1	80-01	64755S	51641
916C	Band, Anchor Plug (Plastic).....	1	80-01	64916-5	51640
090	Axle Stabilizer, Passenger Side (Bushing Type).....	1	80-01	64090	51731S
275	Axle Stabilizer, Both Sides (Bearing Type) (Teckpak).....	1	80-01	T64275	51731B
698	Oil Weir Kit.....	1	80-01	64698A	K51836
701	Chain Snubber	1	80-01	64701	51974
SNAP RINGS					
874L	Holds Pinion Pins to Differential Housing (Spiral) (Superior).....	1	80-01	76874A	53962S
886L	Holds Input Shell to Sun Gear (.138" Thick).....	1	80-01	64886AH	51418G
887L	Holds Output Shaft to Differential.....	2	80-01	64887	N/A
MISCELLANEOUS COMPONENTS					
906G	Spring, Intermediate Servo Cushion.....	1	80-01	64906	51706
908G	Pin, Intermediate Servo (No Groove).....	1	80-01	64908	51708
916	Anchor Plug, Band	1	80-01	64916-5	51640
926I	Spring, 1-2 Accumulator (Purple)	1	80-E85	64926	51704
926I	Spring, 1-2 Accumulator (Purple) Has Thicker Coils Than 64926	1	L85-01	64926A	51704A
927	Piston, 1-2 Accumulator	1	80-01	64927	51962
927	Piston, 1-2 Accumulator (w/ Pin)	1	80-01	64927K	K51962
928	Pin, 1-2 Accumulator	1	80-01	64928	51963
952	Valve, 2-3 Shift (Accumulator)	1	80-01	64741S-1	51964
977K	Return Spring, Low/ Reverse Clutch (Waved).....	1	80-01	54977A	32551
977K	Return Spring, Low/ Reverse Clutch (Diaphragm) (1993 Update).....	1	80-01	64977	K51551
Tool	Low-Reverse Clutch Center Support Remover / Installer	1	80-01	T-1059-B	T-1059-B
Tool	Output Shaft C-Ring Remover / Installer.....	1	80-01	T-1201	T-1201
Tool	Clutch Assembly & Final Drive Remover / Installer	1	80-01	T-1202-A	T-1202-A
Tool	Oil Pump Seal Installer	1	80-01	T-1233	T-1233
Tool	Turbine Shaft Seal Installer / Resizer (Cover Side).....	1	80-01	T-1274	T-1274
Tool	Turbine Shaft Seal Installer / Resizer (Case Side)	1	80-01	T-1274-A	T-1274-A
NOTES					



The LuK RepSet® Clutch Line

The Brand Professionals Trust

When it comes to a job as complex and labor-intensive as a clutch replacement, you can't afford a comeback. Cheap, inferior parts can cost you hundreds of dollars in unreimbursed labor. For over thirty years, smart technicians have staked their reputation – and their customers' satisfaction – on genuine LuK RepSet® clutch and clutch system components.

“Cheaper” Isn't Less Expensive

- The replacement market is full of mix-and-match parts from various sources, a practice that creates quality and installation problems.
- Value-priced brands from offshore manufacturers achieve savings with inferior raw materials, third-world labor and no quality control.
- Quality flaws are not always visibly obvious. Parts might bolt-up, but will fail prematurely – often shortly after installation.

Trust Genuine Original-Equipment Quality

- Every LuK RepSet is 100% functionally tested and guaranteed to meet OEM performance specifications.
- Each LuK RepSet contains everything you need to get the job done right: new clutch, disc, release bearing, pilot bearing, spline tool and lubricant.
- LuK offers a complete line of clutch system components, including flywheels, hydraulic release system components and cables.
- LuK offers the industry's best technical support: online, on-call and in print.

Beyond OE: Upgrading Performance

- LuK PRO GOLD PERFORMANCE® is a high-performance clutch set that's engineered – not modified – to handle extreme conditions without sacrificing clutch life.
- LuK offers heavy-duty upgrades featuring extended-wear friction and beefier components for selected vehicle applications.

Build Your Business With LuK

For more information about the LuK RepSet clutch line, genuine LuK flywheels and hydraulic release system components, visit www.lukclutch.com.

It's your business. Insist on genuine LuK quality, the clutch that vehicle manufacturers specify as standard equipment.



SCHAEFFLER GROUP
AUTOMOTIVE

5370 Wegman Drive • Valley City, OH 44280
www.lukclutch.com • www.lukprogold.com

TH180(MD3) 3L30 TH180C(MD2) w/L/U

4L30E (ML4) 4 SPEED ELECTRONIC - 1990-UP

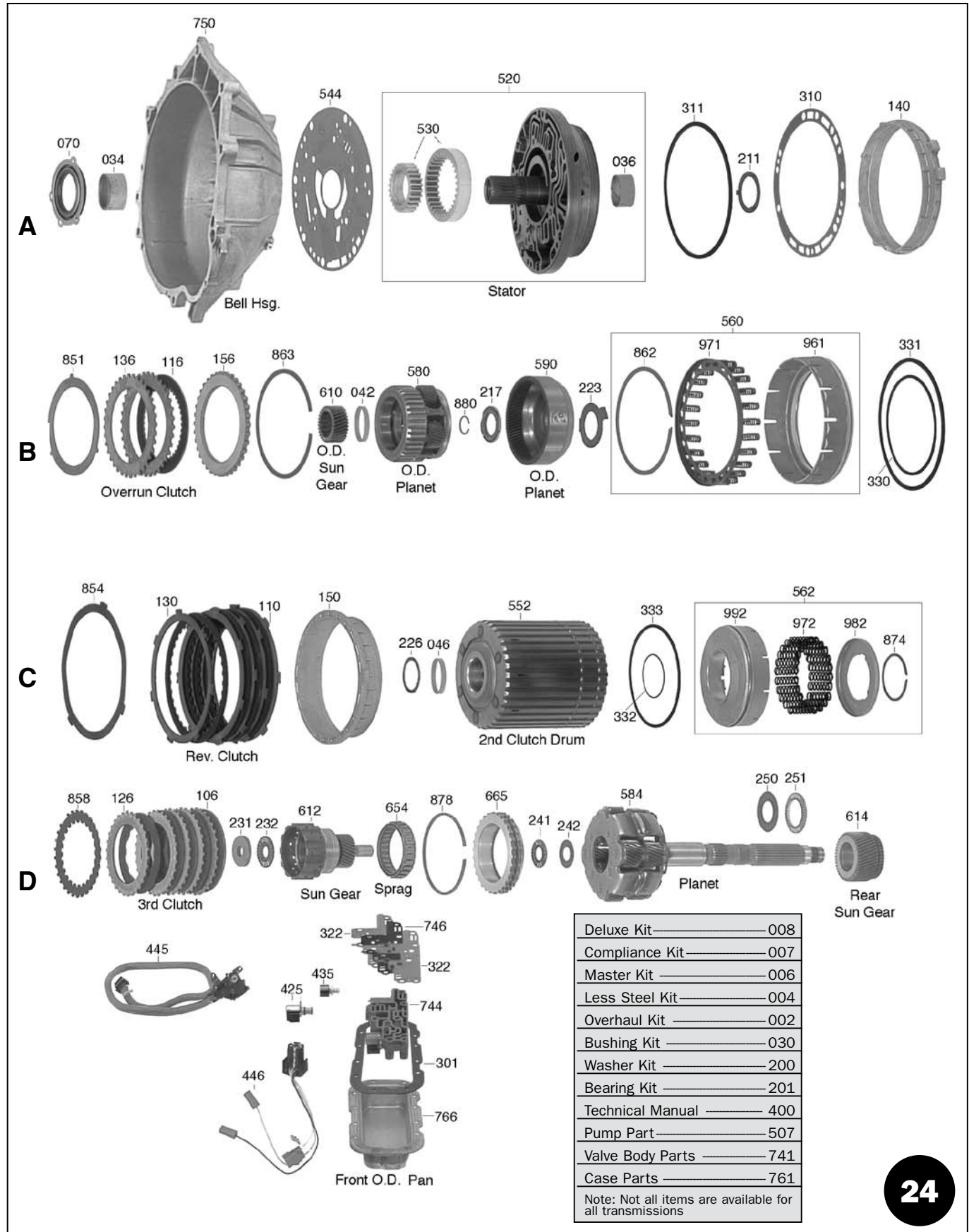

TH180(MD3) 3L30 TH180C(MD2) w/L/U

4L30E (ML4) 4 SPEED ELECTRONIC - 1990-UP

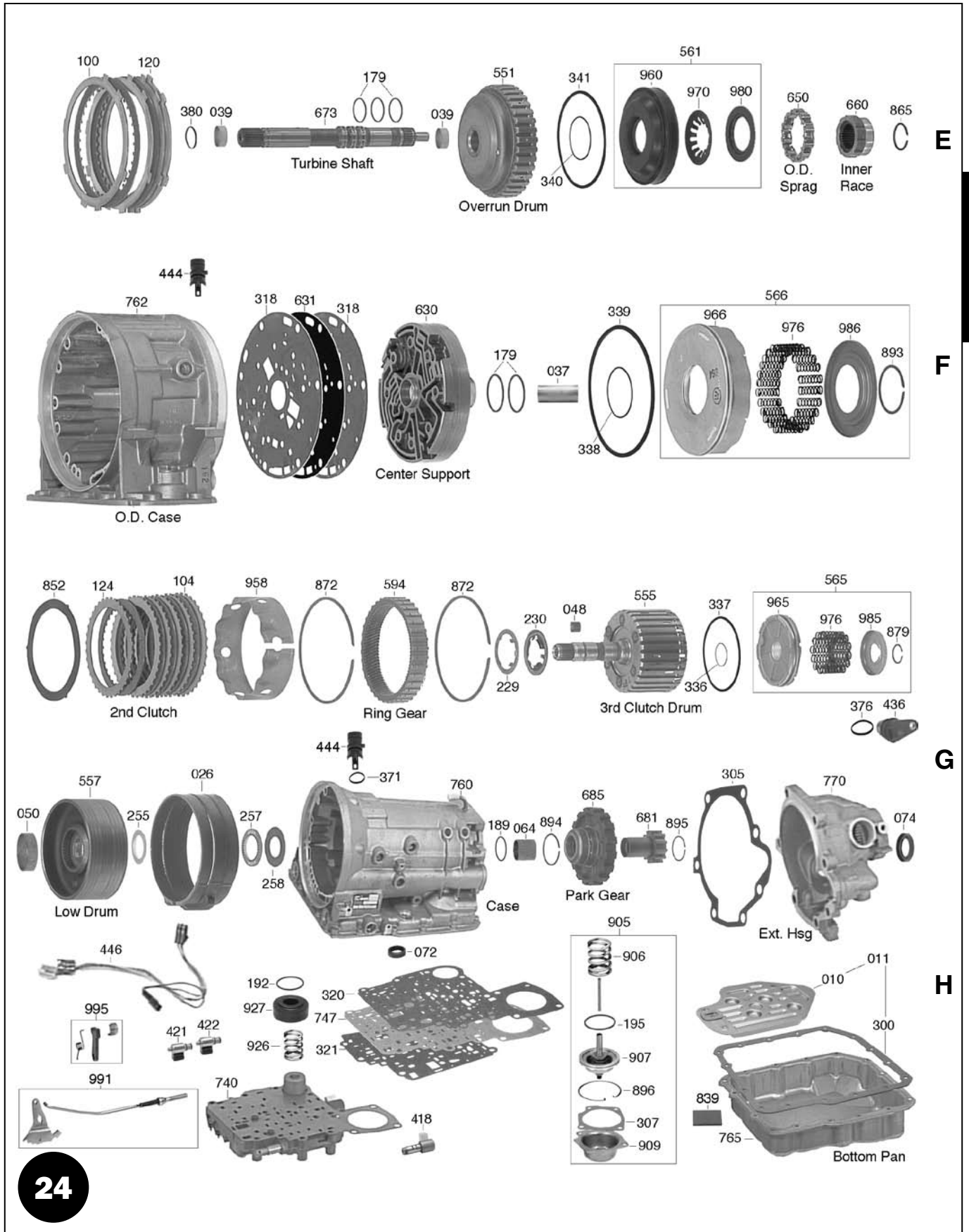

TH180/4L30E

E

F

G

H

4L30E (ML4) 4 SPEED ELECTRONIC - 1990-UP

TH180(MD3) 3L30 TH180C(MD2) w/L/U



24010



24010E



24010E

3L30 - 3 SPEED - 69-Up

Buick Opel	77-87
Chevette	77-87
GEO Tracker	90-Up
Pontiac T-1000	77-87
Jaguar XJS, XJ12	80-92
Holden - Australia	
Ranger - S. Africa	
Post Office Vehicles LLV - 87-Up	
Alpine	
Fiat	Some
77-82	
Peugeot 604	77-87
Straussburg - Germany	
Vauzhaul - Many	
Zimmer Motor Home	
Suzuki Sidekick	

4L30E - 4 SPEED - 90-Up

Cadillac Catera 3.0L	
Isuzu Amigo	
Impulse	
Pickups, Rodeo	91-98
Trooper	90-98
Trooper II	
BMW 325i, 318i, 323i, 328i,	
525i, 528i, Z3 Roadster	91-Up
Honda Passport	94-Up
Acura SLX	98-98

NOTE: Some Isuzu models (88-90) use Toyota A43 Series



24300

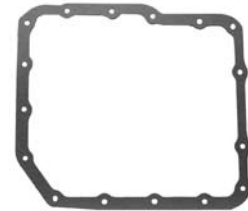

24300AF

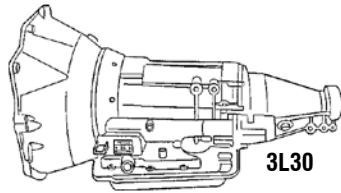

3L30

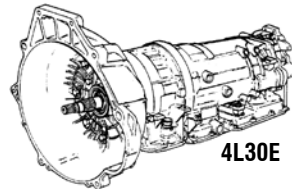

4L30E

ILL.	DESCRIPTION	QTY.	YEAR	PART NO.	REFERENCE NO.
DELUXE KITS (SUPER KITS)					
008D	180,180C (1).....	1	69-Up	24008F	K4100-R
008D	4L30E (w/ .098" 3rd Clutch Friction) (Exc 95-97 BMW).....	1	90-97	24008EF	K4100E-R
008D	4L30E (w/ .063" 3rd Clutch Friction) (Incl 95-97 BMW).....	1	98-Up	24008EAF	K4100F-R
COMPLIANCE KITS (CALIFORNIA KITS)					
007D	180,180C (1).....	1	69-Up	24007F	CK4100-R
007D	4L30E (w/ .098" 3rd Clutch Friction) (Exc 95-97 BMW).....	1	90-97	24007EF	CK4100E-R
007D	4L30E (w/ .063" 3rd Clutch Friction) (Incl 95-97 BMW).....	1	98-Up	24007EAF	CK4100F-R
MASTER OVERHAUL KITS (WITH STEELS)					
006D	180,180C (1).....	1	69-Up	24006F	K4100
006D	4L30E (w/ .098" 3rd Clutch Friction) (Exc 95-97 BMW).....	1	90-97	24006EF	K4100E
006D	4L30E (w/ .063" 3rd Clutch Friction) (Incl 95-97 BMW).....	1	98-Up	24006EAF	K4100F
LESS STEEL KITS					
004D	180,180C (1).....	1	69-Up	24004F	K4100-LS
004D	4L30E (w/ .098" 3rd Clutch Friction) (Exc 95-97 BMW).....	1	90-97	24004EF	K4100E-LS
004D	4L30E (w/ .063" 3rd Clutch Friction) (Incl 95-97 BMW).....	1	98-Up	24004EAF	K4100F-LS
OVERHAUL KITS (W/ RINGS & SEALS)					
002D	180,180C (1).....	1	69-Up	24002F	K41900
002D	4L30E.....	1	90-Up	24002EF	K41900E
GASKET & SEAL KITS (W/O RINGS & SEALS)					
000D	180,180C (1)..... <i>(1) 180, 180C Kits do not include Tracker/Sidekick 2wd Ext Hsg Seal, # 24074A.</i>	1	69-Up	24000F	K41900-1
FILTER KITS					
011H	Filter Kit (180,180C).....	1	69-Up	24011	FK41800
011H	Filter Kit (4L30E) (Exc BMW).....	1	90-Up	24011E	FK41800E
011H	Filter Kit (4L30E) (BMW).....	1	91-Up	24011EA	FK41800F

TH180(MD3) 3L30 TH180C(MD2) w/L/U

4L30E (ML4) 4 SPEED ELECTRONIC - 1990-UP

ILL.	DESCRIPTION	QTY.	YEAR	PART NO.	REFERENCE NO.
FILTERS					
010H	Filter (180,180C).....	1	69-Up	24010	41800
010H	Filter (4L30E) (Exc BMW).....	1	90-Up	24010E	41800E
010H	Filter (4L30E) (BMW)	1	91-Up	24010EA	41800F
015	Screen, PWM Solenoid (3 3/4" Long In Valve Body) (4L30E).....	1	90-Up	24015	41712
018	Screen, Force Motor (In Auxiliary Valve Body) (4L30E)	1	90-Up	24018	41712A
BANDS					
Prefix Key: B = Borg Warner, A = OEM (Exc BW), N = All Other New, R = Relined					
026H	Low (All).....	1	69-Up	24026	41700
BUSHINGS					
030D	Bushing Kit (180,180C).....	1	69-Up	24030	K41901
030D	Bushing Kit (4L30E) (may not incl. Center Support Bushing)	1	90-Up	24030B	K41901A
034A	Pump (Narrow).....	1	69-Up	24034A	41005
034A	Pump (Tighter Tolerance) (Machining Needed).....	1	69-Up	24034	54253-01
034A	Pump (Wide) (Use caution not to cover or block the oil lube hole) (All).....	1	69-Up	44034	8005
036A	Stator Support (All)	1	69-Up	24036	41003
036A	Stator Support (All) (Bronze)	1	69-Up	24036X	41003X
044	Center Support (4L30E)	1	90-Up	24044	41003A
044	Center Support (4L30E) (Bronze)	1	90-Up	24044X	41003AX
046C	2nd Clutch Drum (All)	1	69-Up	24046	41000
050H	Input Sun Gear (All).....	1	69-Up	24050	41009
064H	Case (All).....	1	69-Up	24064	41012
064H	Case (No Walk) (All).....	1	69-Up	24064B	41012X
066	Extension Housing (Exc 90-Up Tracker) 1.630"OD, .940" Tall	1	69-Up	44066B	8008
066	Extension Housing (90-Up Tracker) 1.538"OD, 1.455" Tall.....	1	69-Up	24066C	N/A
METAL CLAD SEALS					
070A	Front (180, 180C)	1	69-Up	24070	41151
070A	Front (4L30E).....	1	90-Up	24070A	41151E
074H	Rear (Some) (180, 180C)	1	69-Up	44074	8850B
074H	Rear (Sidekick 2wd, Tracker 2wd) (180, 180C)	1	92-Up	24074A	41201A
074H	Rear (Sidekick 4wd, Tracker 4wd) (180, 180C)	1	92-Up	67076A	75201M
07H	Rear (4L30E)	1	90-Up	69074	56201B
072H	Linkage Shaft (4L30E)	1	90-Up	84072A	51202A
FRICITION PLATES					
100E	4th Clutch (4L30E).....	3	90-Up	24100	41106
104G	2nd Clutch	3-6	69-Up	24104	41102
106D	3rd Clutch (.063").....	2-5	95-Up	24106A	41104A
106D	3rd Clutch (.100").....	2-5	69-Up	24106	41104
110C	Reverse	2-5	69-Up	24110	41100
116B	Overrun (4L30E)	2	90-Up	24116	41108
STEEL PLATES					
120E	4th Clutch (4L30E).....	4	90-Up	24120	41107
124G	2nd Clutch (.070").....	3-7	69-Up	24124A	41103
124G	2nd Clutch (.083")	3-7	69-Up	24124	41103A
126D	3rd Clutch (.070").....	3-6	69-Up	24126A	41105
126D	3rd Clutch (.083").....	3-6	69-Up	24126	41105A
130C	Reverse (.070")	3-5	69-Up	24130	41101
130C	Reverse (.083")	3-6	69-Up	24130A	41101A
136B	Overrun (4L30E)	2	90-Up	24136	41109
N.I.	Steel Module.....	1	90-Up	24139E	N/A

TH180/4L30E

4L30E (ML4) 4 SPEED ELECTRONIC - 1990-UP

TH180(MD3) 3L30 TH180C(MD2) w/L/U

ILL.	DESCRIPTION	QTY.	YEAR	PART NO.	REFERENCE NO.
MODULATORS					
160	Green Stripe (Non Adjustable) (180, 180C).....	1	69-Up	24160	41820X
160	Blue Stripe (Non Adjustable) (180, 180C).....	1	69-Up	24160B	N/A
160	Dual Green Stripe (Adjustable) (Post Office Vehicles) (180, 180C)	1	69-Up	24160C	41820B
160	Dual Blue Stripe (Adjustable) (Chevrolet) (180, 180C).....	1	69-Up	24160E	41820A
160	Purple Stripe (Adjustable) (GEO Tracker, Suzuki) (180, 180C).....	1	89-Up	24160G	N/A
VALVE BODY RECALIBRATION KITS					
165D	Shift Kit® (180C) (Transgo®).....	1	82-Up	T24165	K41908
165D	Shift Kit® (4L30E) (BMW, Volvo, Cadillac) (Transgo®).....	1	91-04	T24165E	N/A
165D	Shift Correction Package (4L30E) (Superior)	1	90-Up	S24165E	41C03
165D	Valve Body Kit (4L30E) (Trans Lab)	1	90-Up	A24165E	41D02
SEALING RINGS					
175D	Ring Kit (180, 180C Exc Holden)	1	69-Up	24175	K41300
175D	Ring Kit (4L30E)	1	90-Up	24175E	K41300E
THRUST WASHERS					
200D	Pump Washer Kit (All)	1	69-Up	24200B	K41208
211A	Pump Washer & Shim Kit (All).....	1	69-Up	24211K	K41208D
211A	Pump .059" (Yellow) (3 Tabs) (All).....	1	69-Up	24211B	41208
	067" Red=BA, .075" Black=BB, .082" White=BC, .090" Green=BD, .098" Blue=BE				
223B	Overdrive Ring Gear to Overdrive Case (2 Tab) (4L30E)	1	90-Up	54223B	32420
226C	Center Support Selective .063" (Yellow) (4L30E)	1	90-Up	24226A	N/A
	.070" Red=B, .077" Black=C, .085" White=D, .092" Green=E, .099"=Blue=F.....				
229G	2nd Drum to 3rd Drum (Front) (3 Tab Metal) (All)	1	69-Up	24229	41210
229G	2nd Drum to 3rd Drum (Front) (Plastic) (All).....	1	69-Up	24229A	N/A
230G	2nd Drum to 3rd Drum (Rear) (All)	1	69-Up	24230	N/A
GASKETS & O-RINGS					
300H	Gasket, Pan (Cork) (180, 180C)	1	69-Up	24300	13600X
300H	Gasket, Pan (Fiber) (180, 180C).....	1	69-Up	24300F	13600F
300H	Gasket, Pan (Exc BMW) (Cork) (4L30E)	1	90-Up	24300A	N/A
300H	Gasket, Pan (Exc BMW) (Fiber) (4L30E)	1	90-Up	24300AF	13600AF
300H	Gasket, Pan (BMW) (Cork) (4L30E).....	1	90-Up	24300B	N/A
300H	Gasket, Pan (BMW) (Fiber) (4L30E)	1	90-Up	24300BF	13600BF
301D	Gasket, Front Overdrive Pan (Cork) (4L30E).....	1	90-Up	24301A	13605F
301D	Gasket, Front Overdrive Pan (Fiber) (4L30E)	1	90-Up	24301AF	N/A
305H	Gasket, Extension Housing (180, 180C)	1	69-Up	24305	13927
305H	Gasket, Extension Housing (4L30E).....	1	90-Up	24305E	13927B
310A	Gasket, Pump (180, 180C).....	1	69-Up	24310	13601
310A	Gasket, Pump (4L30E).....	1	90-Up	24310E	13601B
310A	O-Ring, Pump & Overdrive Housing (All)	1	69-Up	24311	13602
310A	O-Ring, Overdrive Housing (4L30E).....	1	69-Up	24311	13602
320H	Gasket, Upper Valve Body (4L30E).....	1	90-Up	24320B	K13616E
321H	Gasket, Lower Valve Body (4L30E).....	1	90-Up	24321B	K13616E
TECHNICAL MANUALS					
400D	Tech Manual (180C).....	1	69-Up	24400	N/A
400D	Tech Manual (4L30E)	1	90-Up	24400E	41Y02
400D	Transmission Guide (GM) (4L30E)	1	90-Up	24400EA	N/A
ELECTRICAL COMPONENTS					
418H	Solenoid, PWM (Low Band Control)	1	90-Up	24418	5A-162
421H	Solenoid, 1-2 & 3-4 Shift	1	90-Up	24421E	5A-154
422H	Solenoid, 2-3 Shift	1	90-Up	24422E	5A-155

TH180(MD3) 3L30 TH180C(MD2) w/L/U

4L30E (ML4) 4 SPEED ELECTRONIC - 1990-UP

TH180/4L30E

ILL.	DESCRIPTION	QTY.	YEAR	PART NO.	REFERENCE NO.
ELECTRICAL COMPONENTS (Cont.)					
425D	Solenoid, TCC Lock-Up (180C).....	1	82-Up	D24425B	5A-165
425D	Solenoid, TCC Lock-Up (180C) (Rostra)	1	82-Up	24425B	5R-165
425D	Solenoid, TCC Lock-Up (4L30E).....	1	90-99	24425E	5A-159
425D	Solenoid, TCC Lock-Up (4L30E).....	1	00-Up	34418	5A-151
435D	Solenoid, EPC (Holley) (w/ 2 Gray Screens, 2 Bottom Prongs)	1	90-99	34435A	5D-152A
435D	Solenoid, EPC (Bosch) (w/ 2 White Screens, 2 Bottom Prongs)	1	90-99	34435	5D-152
435D	Solenoid, EPC (Bosch) (w/ 2 Red Screens, 2 Side Prongs)	1	00-Up	56431A	5A-451B
436	Speed Sensor, Output (VSS) (Exc BMW).....	1	90-Up	24436	N/A
444H	Connector, Case (3 Prong)	1	80-Up	74444A	25A-103
444H	Connector, Case (Square 4 Prong) (6 Cyl 90-99) (4 Cyl 90-01)	1	90-01	84444	25A-104
444H	Connector, Case (Round 7 Prong) (6 Cyl 00-Up) (4 Cyl 02-Up).....	1	00-Up	24444E	25A-116C
444H	Connector, Overdrive Housing (5 Prong) (6 Cyl 90-99) (4 Cyl 90-01).....	1	90-01	24444F	25A-116B
444H	Connector, Overdrive Housing (4 Prong) (6 Cyl 00-Up) (4 Cyl 02-Up)	1	00-Up	84444	25A-104
446D	Internal Wire Harness, Case (4 Prong) (Exc BMW) (6 Cyl 90-99) (4 Cyl 90-01)	1	90-99	24446E	35A-116
446D	Internal Wire Harness, Case (6 Prong) (Exc BMW) (6 Cyl 00-Up) (4 Cyl 02-Up).....	1	00-Up	24446EA	35A-116D
446D	Internal Wire Harness, Case (BMW).....	1	91-Up	24446EE	35A-116B
446D	Internal Wire Harness, OD Hsg (5 Prong) (6 Cyl 90-99) (4 Cyl 90-01)	1	90-01	24446EB	35A-116A
446D	Internal Wire Harness, OD Hsg (4 Prong Orange Wire) (6 Cyl 00-Up) (4 Cyl 02-Up) ...	1	00-Up	24446EC	35A-116C
446D	Internal Wire Harness, OD Hsg (4 Prong Blue Wire w/ Push-in TCC)	1	00-Up	24446ED	35A-116F
HARD PARTS					
Prefix Key: D = OEM, A = Aftermarket New, R = Remanufactured					
PUMPS & COMPONENTS					
520A	Stator w/ Gears (.515" OD Pressure Regulator) (4L30E)	1	90-Up	24520E	N/A
520A	Stator w/ Gears (.595" OD Pressure Regulator) (4L30E)	1	90-Up	24520EA	41424E
520A	Stator w/ Gears (4 Valve Type) (4L30E)	1	00-Up	24520EA	N/A
530A	Pump Gears (All .628")	1	69-Up	24530A	K41201
544A	Plate, Pump (180C)	1	82-Up	24544C	41202A
544A	Plate, Pump (4L30E).....	1	90-Up	24544E	N/A
507D	Boost Valve, Pump (Small Ratio Stamped 066) (4L30E)	1	90-Up	24507FB	K41971C
507D	Boost Valve, Pump (Small Ratio Stamped 067) (4L30E)	1	90-Up	24507FC	K41971B
507D	Boost Valve, Pump (Medium Ratio) (4L30E)	1	90-Up	24507F	K41971A
507D	Boost Valve, Pump (Large Ratio) (4L30E).....	1	90-Up	24507FA	K41971
507D	Valve & Sleeve, TCC Reg.....	1	90-Up	24507	K41856
DRUMS & HUBS					
551E	Overrun Clutch (2 Clutch) (4L30E)	1	90-Up	24551	41948
552C	2nd Clutch (All 79-Up)	1	79-Up	24552A	41254
555G	3rd Clutch Drum w/ Shaft (w/ 3 1/2" Long Shaft) (4L30E).....	1	90-Up	24555E	41961E
557H	Low Band (Less Rear Sun Gear) (4L30E)	1	90-Up	24557E	N/A
PLANETS					
580B	Overdrive Planet (31 T Sun Gear) (4L30E)	1	90-Up	24580	41950
583	Planet Package, 3 Gear (3L30) (LLV) (Replaces Coarse or Fine Pitch).....	1	87-Up	24583	K41907A/B
583	Planet Package, 4 Gear (4L30E) (GM) (Slip Yoke) (2)	1	90-Up	24583FB	K41907H
583	Planet Package, 4 Gear (4L30E) (BMW) (Bolt Yoke, .550" Dia Pilot) (2)	1	90-Up	24583F	K41907G
583	Planet Package, 4 Gear (4L30E) (BMW) (Bolt Yoke, .640" Dia Pilot) (2)	1	90-Up	24583FA	K41907J
583	Planet Package, 4 Gear (4L30E) (Isuzu) (2wd) (2).....	1	90-Up	24583EA	K41907D
583	Planet Package, 4 Gear (4L30E) (Isuzu) (4wd) (2).....	1	90-Up	24583E	K41907F
583	Planet Package, 4 Gear (4L30E) (Passport) (4wd) (2)	1	90-Up	24583AA	K41907
590B	Ring Gear, Overdrive Planet (31 T Sun Gear # 610) (4L30E)	1	90-Up	24590	N/A
594G	Ring Gear, Planet (30 T Sun Gear # 612) (4L30E).....	1	90-Up	24594E	N/A
(2) 4L30E Packages include 48 T Input, 46 T Reaction Sun Gear, Ring Gear & Planet					

4L30E (ML4) 4 SPEED ELECTRONIC - 1990-UP

TH180(MD3) 3L30 TH180C(MD2) w/L/U

ILL.	DESCRIPTION	QTY.	YEAR	PART NO.	REFERENCE NO.
SUN GEARS, SHELLS & SUPPORTS					
610B	Sun Gear, Overdrive Planet (31 T) (4L30E)	1	90-Up	24610	41952
612D	Sun Gear, w/ Inner Race (25 T) (180, 180C).....	1	69-86	24612	N/A
612D	Sun Gear, w/ Inner Race (30 T) (All)	1	87-Up	24612E	N/A
614D	Sun Gear, Rear (46 Teeth, Separate From Low Drum) (4L30E)	1	90-Up	24614E	N/A
630F	Center Support (Cast # 069 DD2) (4L30E)	1	90-Up	24630	N/A
630F	Center Support (Cast # 513 FU2) (w/ 2 Valves Inside) (4L30E).....	1	90-Up	24630B	41902
631F	Plate, Overdrive Case to Center Support (4L30E).....	1	90-Up	24631	N/A
SPRAGS					
650E	Sprag, Overdrive (4L30E)	1	90-Up	54650B	32849
654D	Sprag, 3rd Clutch (16 Elements) (All)	1	69-Up	24654	N/A
654D	Sprag, 3rd Clutch (26 Elements) (All)	1	69-Up	74658	61725
SHAFTS					
673E	Turbine Shaft (w/ Check Ball Capsule) (4L30E).....	1	90-Up	24673	N/A
673E	Turbine Shaft (w/o Check Ball Capsule) (4L30E).....	1	90-Up	24673A	N/A
VALVE BODIES					
740H	Valve Body (w/ 3 Solenoid) (4L30E)	1	90-Up	24740E	N/A
CASES & HOUSINGS					
765H	Pan, Bottom Rear (4L30E).....	1	90-Up	24765E	N/A
765H	Pan, Bottom Rear (3.560" Deep) (4L30E).....	1	90-Up	24765EB	N/A
MISCELLANEOUS COMPONENTS					
939	Cover, Overdrive Accumulator (Molded Rubber) (4L30E)	1	95-Up	24939	41530
960E	Piston, Overrun Clutch (Molded Rubber) (4L30E)	1	90-Up	24960	41528N
970E	Spring, Overrun Clutch Return (4L30E).....	1	90-Up	24970	N/A
Tool	Converter Housing To Front Pump Alignment Tool.....	1	69-81	T-1080	T-1080
Tool	Converter Housing To Front Pump Alignment Tool (Pontiac).....	1	82-Up	T-1080-A	T-1080-A
Tool	Pump Alignment Tool (4L30E)	1	90-Up	T-1080-B	T-1080-B
Tool	Third Clutch Ring Compressor - Late 79-Up	1	79-Up	T-1085-A	T-1085-A
Tool	Governor Bore Case Sleeve Tool.....	1	69-Up	T-1195	T-1195
Tool	Governor Bore Case Sleeve	1	69-Up	T-1195-SL	T-1195-SL
NOTES					



DRIVEN
to be the
BEST

At Transtar, we are committed to offer the highest quality parts and services for all our customers. We understand that our business is dependant on the success of yours. That's why we provide you with quality parts from name brands you can trust, and bring them to you at competitive prices.

Contact us today at
(800) 359-3339
www.Transtar1.com

Quality Parts

Transtar has the most comprehensive product line in the industry – virtually everything that you'll need to do a quality rebuild for your customers. Start with a Transtar Kit and a Recon™ remanufactured Torque Converter, and then add OE quality Electrical and Hard Parts. You'll have the parts you need, on time, to do the job right the first time.

Dependable Service

Our sales reps and technical team are the best and most knowledgeable in the transmission repair industry. Your rep can help you find the exact parts you need, and tell you precisely when to expect them.

Cutting Edge Technology

Our online ordering system, Transtar eSource™, allows you instant access to product information, on-hand inventory, and pricing details. Access your account, pay invoices, and create and submit orders from the comfort of your office – any time of the day or night.

On-Time Delivery

With our expansive inventory and local delivery routes, we are proud to provide same-day service to most markets in the continental United States. Transtar is the obvious choice to be your transmission parts supplier.



TLT-TS-001

TH200-4R (MW9)

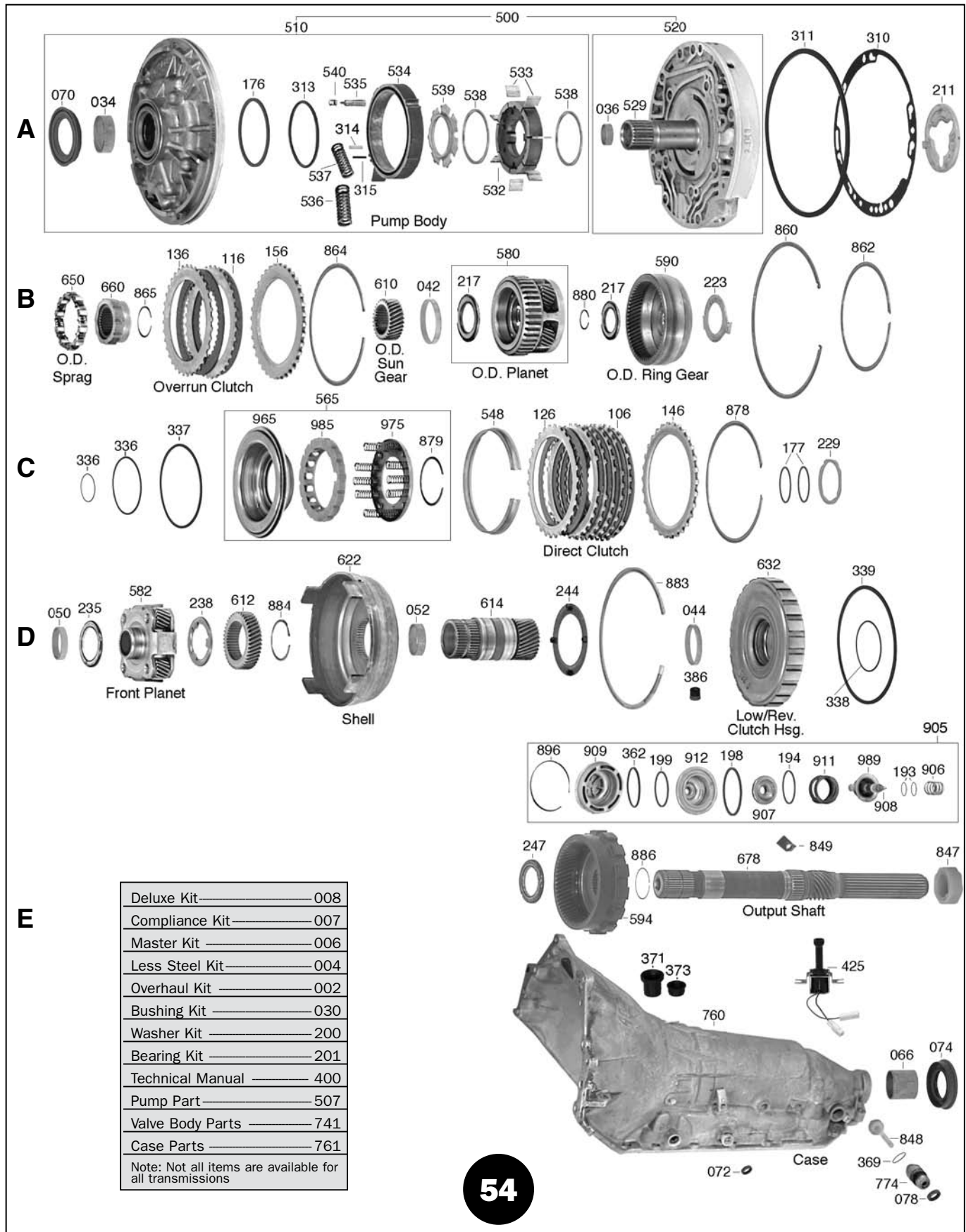

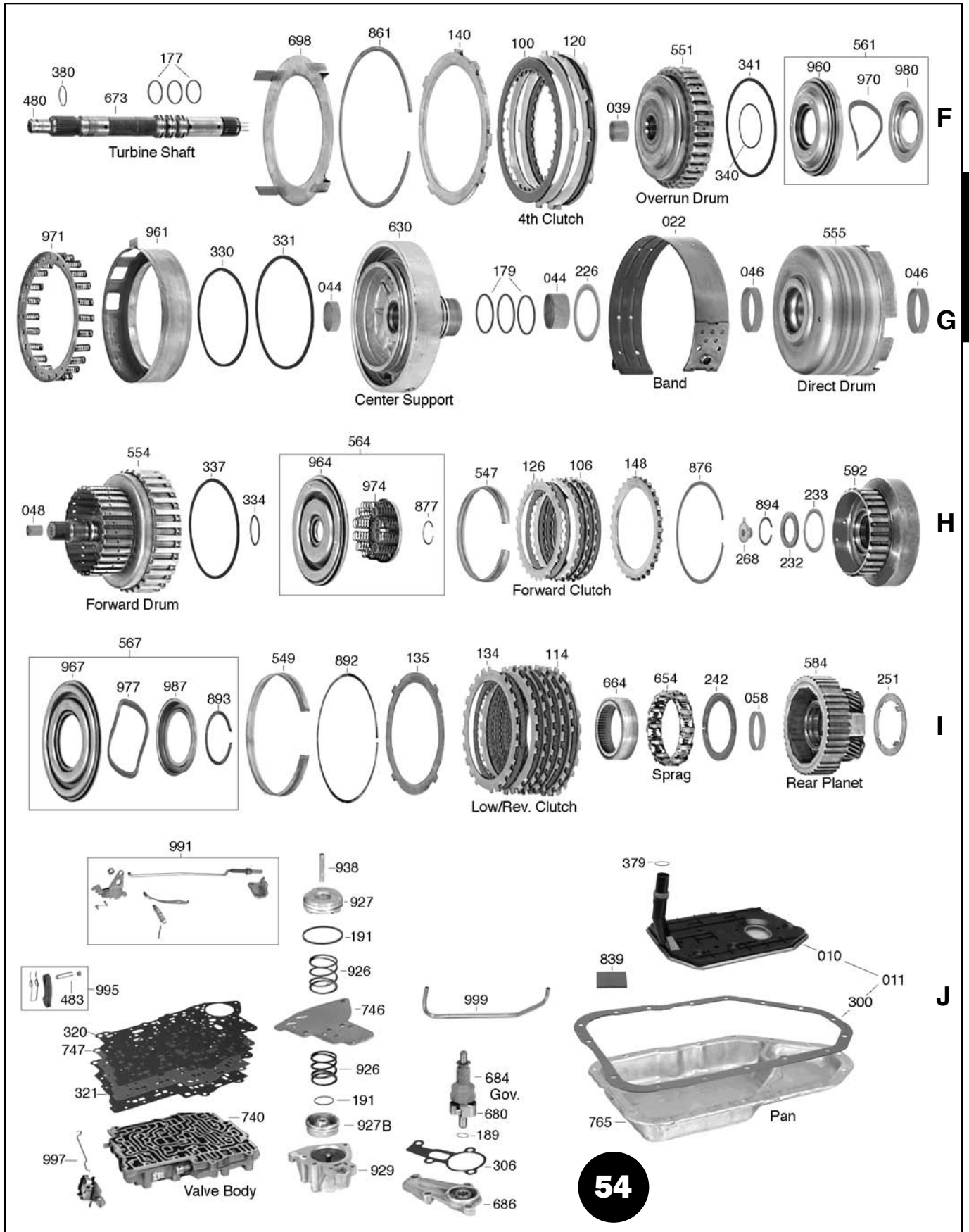

TH200(M29), TH200C(MV9) TH200-4R(MW9)



54010A



54010AA



54010B



54300A



54300B

TH 200-4R	
Buick	81-90
Cadillac	81-89
Chevrolet	81-90
Oldsmobile	81-90
Pontiac	81-90

TH 200, 200C	
Buick	76-87
Cadillac	78-79
Chevrolet	76-87
Isuzu Pickups	81-87
Jaguar (some)	82-87
LUV Trucks	76-87
Oldsmobile	76-83
Opel	76-79
Pontiac	76-87

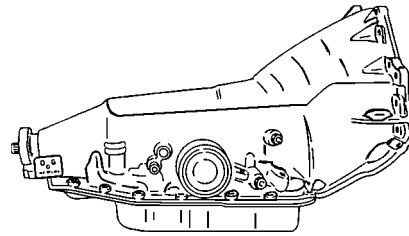

200-4R Rear Wheel Drive

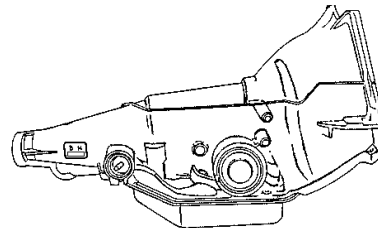

TH 200 Rear Wheel Drive

ILL.	DESCRIPTION	QTY.	YEAR	PART NO.	REFERENCE NO.
DELUXE KITS (SUPER KITS) (1)					
008E	200, 200C	1	76-E79	54008AM	K3200B-R
008E	200, 200C	1	L79-87	54008AA	K3200A-R
008E	200-4R	1	81-90	54008B	K3200M-R
COMPLIANCE KITS (CALIFORNIA KITS) (1)					
007E	200, 200C	1	76-E79	54007A	CK3200B-R
007E	200, 200C	1	L79-87	54007AA	CK3200A-R
007E	200-4R	1	81-90	54007B	CK3200M-R
MASTER OVERHAUL KITS (WITH STEELS) (1)					
006E	200, 200C	1	76-87	54006A	K3200
006E	200-4R	1	81-90	54006B	K3200M
LESS STEEL KITS (1)					
004E	200, 200C	1	76-87	54004A	K3200-LS
004E	200-4R	1	81-90	54004B	K3200M-LS
OVERHAUL KITS (W/ RINGS & SEALS) (1)					
002E	200, 200C	1	76-87	54002A	K32900G
002E	200-4R	1	81-90	54002B	K32900N
GASKET & SEAL KITS (W/O RINGS & SEALS) (1)					
000E	200, 200C	1	76-87	54000A	K32900G-1
000E	200-4R	1	81-90	54000B	K32900N-1
FILTER KITS (1)					
011J	Filter Kit, Brass (200) (Shallow Pan)	1	76-E79	54011A	FK32710
011J	Filter Kit, Nylon (200) (Deep Pan)	1	L79-87	54011AA	FK32710A
011J	Filter Kit (200-4R)	1	81-90	54011B	FK32710M
<i>(1) - To order Kits with Fiber pan gaskets, add an "F" suffix</i>					
FILTERS					
010J	Brass (200) (Shallow Pan)	1	76-E79	54010A	32710
010J	Nylon (200) (Deep Pan)	1	L79-87	54010AA	32710A
010J	Filter (200-4R)	1	81-90	54010B	32710M
016	Screen, Pump Solenoid (200-4R)	1	81-90	54016B	34713

TH200(M29), TH200C(MV9) TH200-4R (MW9)

ILL.	DESCRIPTION	QTY.	YEAR	PART NO.	REFERENCE NO.
BANDS					
Prefix Key: B = Borg Warner, A = OEM (Exc BW), N = All Other New, R = Relined					
022G	Intermediate Flex.....	1	76-90	54022A	32700F
022G	Intermediate Flex (High Performance)	1	76-90	54022AK	32700X
022G	Intermediate Flex (High Performance) (Wide).....	1	76-90	54022BK	N/A
BUSHINGS					
030E	Bushing Kit (200, 200C).....	1	76-87	54030A	K32901
030E	Bushing Kit (200-4R)	1	81-90	54030B	K32901M
034A	Pump Body (200, 200C)	1	76-87	54034A	32005
034A	Pump Body (200-4R).....	1	81-90	74034	61005
034A	Pump Body (Sure Seal) (Teckpak)	1	81-90	T54034A	N/A
036A	Stator Support (Front)	1	76-90	54036A	32006
037	Stator Support (Rear).....	1	76-87	54037A	320063
039F	Overrun Drum	1	81-90	54039B	32017
042B	Overdrive Planet Bushing.....	1	81-90	64044	51011
044D	Center Support (Front)	1	81-90	44037	35003
044D	Low/ Reverse Clutch Housing (Center Support)	1	76-90	54044A	32008
044D	Center Support (Direct Drum Support) (Rear).....	1	81-90	54044B	32020
044D	Center Support (Front) (Forward Drum Support).....	1	81-90	54044C	32019
046G	Direct Drum (Front) (200, 200C)	1	81-90	54046AA	32000
046G	Direct Drum (Front) (200-4R).....	1	81-90	54046B	32000A
046G	Direct Drum (Rear, Babbitt)	1	81-90	54046BA	N/A
046G	Direct Drum (Rear, Bronze).....	1	81-90	54046A	32001
048H	Forward Drum (Pilot)	1	81-90	54048B	32015
050D	Front Ring Gear	1	76-90	54050A	32002
052D	Rear Sun Gear.....	1	76-90	54052A	32007
058I	Rear Planet	1	76-90	54058A	32004
066E	Extension Housing (Babbitt)	1	76-90	44066	8008A
066E	Extension Housing (Bronze)	1	76-90	44066B	8008
METAL CLAD SEALS					
070A	Front.....	1	81-90	74070	61151C
072E	Linkage Shaft.....	1	81-90	44072	38511
074E	Rear.....	1	81-90	44074	8850B
075	Drive Shaft Yoke Seal (Teckpak)	1	81-90	T44075	T-9145R
078E	Speed-O Driven Gear Shaft.....	1	81-90	44078X	3991LS
089	Retainer (Front Seal Lock)	1	81-90	74089	61991
FRICTION PLATES					
100F	4th Clutch	2	81-90	54100B	32107
100F	4th Clutch (Hi-Performance) (Blue)	2	81-90	R54100BHP	32107X
100F	4th Clutch (Hi-Performance) (Red)	2	81-90	A54100BHP	32107R
106C/H	Forward & Direct.....	6-11	76-90	54106A	32103
106C/H	Forward & Direct (Hi-Performance) (Blue)	6-11	76-90	R54106AHP	32103X
106C/H	Forward & Direct (Hi-Performance) (Red).....	6-11	76-90	A54106AHP	32103R
114I	Low & Reverse	4-6	76-90	54114A	32102A
114I	Low & Reverse (Hi-Performance) (Red)	4-6	76-90	A54114AHP	32102AR
116B	Overrun	2	81-90	54116B	32108
116B	Overrun (Hi-Performance) (Blue).....	2	81-90	R54116BHP	32108X
116B	Overrun (Hi-Performance) (Red)	2	81-90	A54116BHP	32108R
STEEL PLATES					
120F	4th Clutch	3	81-90	54120B	32109
120F	4th Clutch (Kolene)	1	81-90	54120BK	32109K
126C	Direct (.090")	5-6	76-90	54126A	32104

TH200, 200-4R

TH200(M29), TH200C(MV9) TH200-4R(MW9)

ILL.	DESCRIPTION	QTY.	YEAR	PART NO.	REFERENCE NO.
STEEL PLATES (Cont.)					
126C	Direct (.090") (Kolene)	1	76-90	54126AK	32104K
126C	Direct (.100") (Oversized)	AR	76-90	54126AX	32104X
126H	Forward (.077")	2-3	76-90	54126AA	32100
126H	Forward (.077") (Kolene).....	1	76-90	54126AAK	32100K
126H	Forward (.060") (Waved)	1	76-90	54126AB	32105
126H	Forward (.060") (Waved) (Kolene).....	1	76-90	54126C	32100KX
134I	Low & Reverse (.076")	6	76-90	54134A	32101
134I	Low & Reverse (.076") (Kolene)	1	76-90	54134AK	32101K
134I	Low & Reverse (.092") (Oversized)	AR	76-90	54134AX	N/A
135I	Low & Reverse (Waved)	1	76-90	54135A	32101A
136B	Overrun Clutch	2	81-90	54136B	32110
N.I.	Steel Module (200, 200C)	1	76-87	54139A	N/A
N.I.	Steel Module (200-4R).....	1	81-90	54139B	N/A
PRESSURE PLATES					
Prefix Key: D = OEM, A = Aftermarket New, R = Remanufactured					
140F	4th Clutch (Top)	1	81-90	54140B	N/A
156B	Overrun Clutch.....	1	81-90	54156B	N/A
VALVE BODY RECALIBRATION KITS					
165E	Shift Kit®, 200 1976-78 (Transgo®)	1	76-78	T54165A	K32908
165E	Shift Kit®, 200 1979-87 (Transgo®)	1	79-87	T54165AA	K32908A
165E	Shift Kit®, 200-4R (Transgo®)	1	81-90	T54165B	K32908M
165E	Valve Body Kit, 200, 200C (Superior)	1	76-87	S54165A	N/A
165E	Valve Body Kit, 200-4R (Superior).....	1	81-90	S54165B	32C04
165E	Valve Body Kit, 200-4R w/ Steel Boost Valve (Superior).....	1	81-90	S54165BV	N/A
165E	Valve Body Kit, 200-4R Hi-Performance (Superior).....	1	81-90	S54171B	32C-HP
165E	Reprogramming Kit™, Automatic: Crisp to Full Race (Transgo®)	1	81-90	T54171B	200-4R-HD2
165E	Pump Ring Kit, NoYoYo Hardened Steel Rings & (STD) Springs (Transgo®).....	1	81-90	T74165B	K32804
165E	Pump Ring Kit, NoYoYo Hi-Perf *Engines over 5500 RPM (Transgo®)	1	82-90	T74165HP	K32804H
SEALING RINGS					
175E	Ring Kit (Metal) (200, 200C)	1	76-87	54175A	K32903
175E	Ring Kit (Teflon) (200, 200C)	1	76-87	54175AT	K32903T
175E	Ring Kit (Metal & Teflon) (200-4R)	1	81-90	54175B	K32903M
176A	Pump Slide to Body (Metal) (200-4R Only).....	1	81-90	54176B	32320
177C	Forward Drum Shaft (Teflon, Scarf Cut).....	2-4	76-90	54177AT	N/A
177C	Forward Drum Shaft (Teflon, Solid Ring) (200-4R Only).....	1	81-90	54177BST	N/A
179G	Center Support (Direct Drum Support) (Metal) (200-4R Only).....	3	81-90	54179B	32321
189J	Governor (Teflon)	1	81-90	54189BT	N/A
191J	3-4 Accumulator (Teflon)	1-2	76-90	54191AT	N/A
191J	1-2 Accumulator (Teflon) (200-4R Only).....	1	81-90	54191BT	N/A
193E	Intermediate Servo Pin (Teflon).....	1	76-90	54193BT	N/A
538A	Pump Rotor to Vane Ring (Steel) (200-4R Only)	2	81-90	54538BS	32322SP
THRUST WASHERS					
200E	Washer Kit (w/o Selectives) (200, 200C).....	1	76-87	54200A	K32907
200E	Washer Kit (w/o Selective) (200-4R)	1	81-90	54200B	K32907M
200E	Washer Kit, Forward Drum to Hub (w/ Selectives) (200, 200C, 200-4R)	1	76-90	54200AA	K32907X
211A	Stator (#1, .169") (Scarlet)	1	81-90	54211B	32600
211A	Stator (#2, .174") (White)	1	81-90	54211BA	32600A
211A	Stator (#3, .178") (Brown)	1	81-90	54211BB	32600B
211A	Stator (#4, .184") (Grey).....	1	81-90	54211BC	32600C
211A	Stator (#5, .188") (Yellow)	1	81-90	54211BD	32600D
211A	Stator (#6, .193") (Light Blue).....	1	81-90	54211BE	32600E

TH200(M29), TH200C(MV9) TH200-4R (MW9)

TH200, 200-4R

ILL.	DESCRIPTION	QTY.	YEAR	PART NO.	REFERENCE NO.
THRUST WASHERS (Cont.)					
211A	Stator (#7, .198") (Purple)	1	81-90	54211BF	32600F
211A	Stator (#8, .202") (Orange)	1	81-90	54211BG	32600G
211A	Stator (#9, .207") (Green)	1	81-90	54211BH	32600H
223B	Overdrive Ring Gear to Center Support	1	81-90	54223B	32420
226	Pump to Direct Drum (200, 200C)	1	76-87	54226A	32401
226G	Center Support to Direct Drum (200-4R)	1	81-90	54226B	32421
229C	Direct Drum to Forward Drum	1	81-90	54229A	32402
232H	Forward Drum to Hub (#3, .131") Yellow	1	76-90	54232B	32212B
232H	Forward Drum to Hub (#4, .138") Blue	1	76-90	54232C	32212C
232H	Forward Drum to Hub (#5, .145") Red	1	76-90	54232D	32212D
232H	Forward Drum to Hub (#6, .152") Brown	1	76-90	54232E	32212E
232H	Forward Drum to Hub (#7, .159") Green	1	76-90	54232F	32212F
232H	Forward Drum to Hub (#8, .166") Black	1	76-90	54232G	32212G
232H	Forward Drum to Hub (#9, .173") Pink	1	76-90	54232H	32212H
233H	Forward Hub to Spacer	1	76-90	54233A	32403
242I	Rear Planet to Sprag Race	1	76-90	54242A	32408
244D	Shell to Low/ Reverse Clutch Housing .060" (Plastic)	1	76-90	54244A	32406A
244D	Shell to Low/ Reverse Clutch Housing .080" (Plastic)	1	76-90	54244AA	32406X
244D	Shell to Low/ Reverse Clutch Housing (Metal)	1	76-90	54244AB	32406
251I	Rear Planet to Rear Ring Gear	1	76-90	54251A	32409
266	Driven Governor Gear to Case	1	76-90	54266A	N/A
268H	Forward Drum to Output Shaft (# 1 .068" Thick) White	1	76-90	54268	32400
268H	Forward Drum to Output Shaft (# 2 .073" Thick) Neutral	1	76-90	54268A	32400A
268H	Forward Drum to Output Shaft (# 3 .078" Thick) Black	1	76-90	54268B	32400B
268H	Forward Drum to Output Shaft (# 4 .083" Thick) Green	1	76-90	54268C	32400C
268H	Forward Drum to Output Shaft (# 5 .088" Thick) Red	1	76-90	54268D	32400D
268H	Forward Drum to Output Shaft (# 6 .093" Thick) Purple	1	76-90	54268E	32400E
268H	Forward Drum to Output Shaft (# 7 .098" Thick) Brown	1	76-90	54268F	32400F
268H	Forward Drum to Output Shaft (# 8 .103" Thick) Orange	1	76-90	54268G	32400G
268H	Forward Drum to Output Shaft (# 9 .108" Thick) Yellow	1	76-90	54268H	32400H
268H	Forward Drum to Output Shaft (# 10 .113" Thick) Light Blue	1	76-90	54268J	32400J
268H	Forward Drum to Output Shaft (# 11 .118" Thick) Light Tan	1	76-90	54268K	32400K
268H	Forward Drum to Output Shaft (# 12 .123" Thick) Tan	1	76-90	54268L	32400L
268H	Forward Drum to Output Shaft (# 13 .128" Thick) Rose	1	76-90	54268M	32400M
268H	Forward Drum to Output Shaft (# 14 .133" Thick) Light Green	1	76-90	54268N	32400N
268H	Forward Drum to Output Shaft (# 15 .138" Thick) Smoke	1	76-90	54268P	32400P
BEARINGS					
201E	Bearing Kit (200, 200C)	1	76-87	54201A	K32907K
201E	Bearing Kit (200-4R)	1	81-90	54201B	K32907C
217B	Overdrive Planet to Overdrive Ring Gear	1	81-90	54217B	32425B
235D	Front Planet to Hub	1	76-90	54235A	32404
238D	Front Planet to Sun Gear	1	76-90	54238A	32405
242I	Rear Planet to Sprag Race	1	76-90	54242AA	32408A
247E	Sun Gear to Rear Ring Gear	1	76-90	54247A	32409A
GASKETS & O-RINGS					
300J	Gasket, Pan (Cork) (200, 200C)	1	76-87	54300A	13900X
300J	Gasket, Pan (Fiber) (200, 200C)	1	76-87	54300AF	13900F
300J	Gasket, Pan (Cork) (200-4R)	1	81-90	54300B	13910X
300J	Gasket, Pan (Fiber) (200-4R)	1	81-90	54300BF	13910F
306J	Gasket, Governor Cover	1	81-90	54306B	13978
308	Gasket, Accumulator Housing to Plate	1	81-90	54308B	13979
309	Gasket, Pump Bolt Washer	6	76-90	44309	13268A
310A	Gasket, Pump to Case (200, 200C)	1	76-78	54310A	N/A
310A	Gasket, Pump to Case (200, 200C)	1	79-Up	54310AB	13901

TH200(M29), TH200C(MV9) TH200-4R(MW9)

ILL.	DESCRIPTION	QTY.	YEAR	PART NO.	REFERENCE NO.
GASKETS & O-RINGS (Cont.)					
310A	Gasket, Pump to Case (200-4R).....	1	81-90	54310B	13981
311A	O-Ring, Front Pump (200, 200C).....	1	76-87	54311A	13902
311A	O-Ring, Front Pump (200-4R)	1	81-90	54311B	13980
313A	O-Ring, Pump Slide.....	1	81-90	54313B	13982
314A	Seal, Pump Slide (Rubber)	1	81-90	54314B	13768
315A	Seal, Pump Slide (Teflon)	1	81-90	54315B	13762
320J	Gasket, Upper Valve Body (200C).....	1	79-Up	54320AB	13926B
320J	Gasket, Upper Valve Body (200-4R)	1	81-90	54320B	13976
321J	Gasket, Lower Valve Body (200C)	1	79-Up	54321AB	13926C
321J	Gasket, Lower Valve Body (200-4R).....	1	81-90	54321B	13977
326	Gasket, Filter (200, 200C)	1	76-87	54326A	13903
328	O-Ring, TCC Solenoid	1	81-90	44380	13917
345	O-Ring, Governor Cover (Outer) (200, 200C).....	1	76-87	54345A	3131L
345	O-Ring, Governor Cover (Inner) (200, 200C)	1	76-87	54345AA	13915
362	O-Ring, Servo Cover O-Ring (200, 200C).....	1	76-87	54362A	13920
368	O-Ring, Speed-O Sleeve (Inner) (200, 200C).....	1	76-87	44369B	3410L
352	Lathe Cut Seal, 1-2 Accumulator	1	81-90	54352A	13965
361	Lip Seal Kit, Servo.....	1	81-90	54361AK	K32900-3
371E	Boot, Filler Boot.....	1	76-90	44371B	13925
373E	Boot, Detent Cable	1	76-90	54373B	13581
386	Seal/Cup Plug, Low/ Reverse Clutch Housing	1	76-90	54386A	13969
N.I.	External Seal Kit (200-4R)	1	81-90	54390B	SK32900M-2
TECHNICAL MANUALS					
400E	Tech Manual (200C).....	1	76-87	54400A	32Y01
400E	Tech Manual (200-4R)	1	81-90	54400B	32Y02
ELECTRICAL COMPONENTS					
411	Switch, 3rd Gear Pressure (Preset) (200, 200C).....	1	83-87	54411A	15A-114
411	Switch, High Gear Pressure 1 Prong (Normally Closed) (200-4R)	1	81-90	54411B	15D-112
412	Switch, Valve Body Oil Pressure Switch (2 Button) (200-4R)	1	81-90	64412	15A-111
416	Switch, Lock-Up Delay (42-46 PSI)	1	76-90	54416AA	N/A
416	Pressure Switch (4-3) Pulse Signal (2-Prong) w/ Tube (200-4R).....	1	81-90	54416BA	15D-117
425E	Solenoid (TCC) (Universal) (200, 200C)	1	76-87	84425	5R-148
425E	Solenoid (TCC) 2 Wire (1 Wire in Connector) (200, 200C)	1	81-87	54425AB	5A-115
425E	Solenoid (TCC) 2 Wire (2 Wires in Connector) (200, 200C)	1	81-87	54425A	5D-113
425E	Solenoid (TCC) 3 Wire (2 Wires in Connector) (200, 200C)	1	83-87	T84425	5U-148
425E	Solenoid, Universal (200-4R)	1	81-90	54425B	5U-147
425E	Solenoid (w/ 262, 305 CI) (200-4R).....	1	82-86	54425BA	5A-120
425E	Solenoid (w/ 231 CI V-6) (200-4R).....	1	84-86	54425BB	5D-122
425E	Solenoid (w/ 250, 252, 305, 307) w/o 4-3 Pulse (200-4R).....	1	82-87	54425BD	5D-119
444	Connector, Case (3 Prong)	1	76-90	74444A	25A-103
444	Connector, Case (4 Prong)	1	76-90	84444	25A-104
444	Connector, Case (Universal 2, 3, 4 Prong)	1	76-90	84444U	N/A
N.I.	Lock-up Delay Module For Vehicle w/ Speed Sensor.....	1	76-90	LU1	30A-100
HARD PARTS					
Prefix Key: D = OEM, A = Aftermarket New, R = Remanufactured					
PUMPS & COMPONENTS (200, 200C)					
500	Pump Non Lock-Up (200)	1	77-78	54500AA	N/A
500	Pump Non Lock-Up (200)	1	79-80	54500AC	N/A
500	Pump Lock-Up (200C)	1	79-87	54500AB	32200B
530	Pump Gears (.777") (200, 200C)	1	76-87	54530AB	K32201B
507	Pressure Regulator Valve Kit (200, 200C)	1	76-87	54507PK	K32879
507	Valve Kit, Lock-Up Valve (Non-Stick) (Self Cleaning) (200C Only)	1	79-87	54507A	K32877

TH200(M29), TH200C(MV9) TH200-4R (MW9)

TH200, 200-4R

ILL.	DESCRIPTION	QTY.	YEAR	PART NO.	REFERENCE NO.
PUMPS & COMPONENTS (200-4R)					
500A	Pump (Cast # 150 on Stator, # 149 on Body) (200-4R)	1	81-90	54500B	N/A
500A	Pump (Cast # 088 on Stator, # 082 or 690 on Body) (200-4R)	1	81-90	54500BA	32200C
529A	Shaft, Stator Tube w/ Bushing	1	81-90	54529B	32969M
531	Rotor Kit, 10 Vane (w/ Slide) (.7074")	1	81-90	74531AK	K32800A
532A	Rotor, 10 Vane Type (Use w/ 54539BA & 64533 to retro fit 7 vane rotors)	1	81-90	54532BA	32802A
533A	Vane	6-10	81-90	64533	32800
533A	Vane Kit (10 Vanes)	1	81-90	74533K-1A	K32801A
533A	Vane & Ring Kit (10 Vane & Rings)	1	81-90	74533K	N/A
534A	Pump Slide (.7069")	1	81-90	54534A	32803
534A	Pump Slide (.7074")	1	81-90	54534B	N/A
535A	Pivot Pin, Pump Slide	1	81-90	54535B	32805
536A	Spring Kit, Pump Slide Spring (Outer & Inner)	1	81-90	74536K	K61210
536A	Spring, Pump Slide Spring (Outer)	1	81-90	74536	N/A
537A	Spring, Pump Slide Spring (Inner)	1	81-90	74537	N/A
538A	Ring, Pump Rotor to Vane (Steel)	2	81-90	54538BS	32322SP
539A	Rotor Guide, 7 Vane	1	81-90	54539B	32422
539A	Rotor Guide, 10 Vane	1	81-90	54539BA	32422A
540A	Spring, Under Pivot Pin	1	81-90	54540B	32806
176A	Pump Slide to Body (Metal)	1	81-90	54176B	32320
314A	Seal, Pump Slide (Rubber)	1	81-90	54314B	13768
315A	Seal, Pump Slide (Teflon)	1	81-90	54315B	13762
507E	Valve, Pressure Regulator	1	81-90	74507B	61964
507E	Spring, Pressure Regulator Valve (Orange)	1	81-90	54507BP-3	N/A
507E	Spring, Pressure Regulator Valve (Green)	1	81-90	54507BP-3A	N/A
507E	Spring, Pressure Regulator	1	81-90	54507P-3	61965
507E	T.V. Boost Valve & Sleeve, .500" OD Valve	1	81-90	74507TK	K61976E
507E	T.V. Boost Valve & Sleeve, .471" OD Valve	1	81-90	74507TAK	K61976G
DRUMS & HUBS					
551F	Overrun (200-4R)	1	81-90	54551B	32723M
554H	Forward (200-4R)	1	81-90	54554B	32725M
555	Direct (200, 200C)	1	76-87	54555A	32726
555G	Direct (200-4R)	1	81-90	54555B	32726M
PLANETS					
580B	Overdrive	1	81-90	54580B	32817
582D	Front	1	76-90	54582A	32747
584I	Rear	1	76-90	54584A	32730
590B	Ring Gear, Overdrive Planet	1	81-90	54590B	N/A
592H	Ring Gear, Front Planet	1	76-90	54592A	N/A
594E	Ring Gear, Rear Planet	1	76-90	54594A	32749
SUN GEARS, SHELLS & SUPPORTS					
610B	Sun Gear, Overdrive Planet	1	81-90	54610B	N/A
612D	Sun Gear, Front Planet	1	76-90	54612A	N/A
614D	Sun Gear, Rear Planet	1	76-90	54614A	32728B
622D	Shell, Input Drum	1	76-90	54622A	32729
622D	Shell, Input Drum (Hardened)	1	76-90	54622AH	32729H
630G	Center Support (4th Clutch) (Aluminum)	1	81-90	54630B	32821
632D	Low/ Reverse Clutch Housing (Center Support) (Steel)	1	76-90	54632A	32727
SPRAGS					
650B	Sprag, Overdrive	1	81-90	54650B	32849
654I	Sprag, Low Clutch	1	76-90	54654A	32502AH

TH200(M29), TH200C(MV9) TH200-4R(MW9)

ILL.	DESCRIPTION	QTY.	YEAR	PART NO.	REFERENCE NO.
GOVERNORS					
680J	Governor, 1 Spring (13 T) (200, 200C).....	1	76-87	54680AC	32410C
680J	Governor, 1 Spring (14 T) (200, 200C).....	1	76-87	54680A	32410A
680J	Governor, 2 Spring (13 T) (200, 200C).....	1	76-87	54680AB	32410B
680J	Governor, 2 Spring (14 T) (200, 200C).....	1	76-87	54680AA	N/A
680J	Governor (12 T Speed-O-Gear) (200-4R).....	1	81-90	54680BA	32827A
680J	Governor (13 T Speed-O-Gear) (200-4R) (Buick/Olds w/ 301).....	1	81-90	54680B	32827
684J	Gear Kit, Governor (13 T) (200, 200C).....	1	76-87	54684AA	32411B
684J	Gear Kit, Governor (14 T) (200, 200C).....	1	76-87	54684A	N/A
684J	Gear Kit, Governor (10 Tooth Speedo) Green (200-4R).....	1	81-90	54684BC	N/A
684J	Gear Kit, Governor (12 Tooth Speedo) Red (200-4R).....	1	81-90	54684B	DK32412A
684J	Gear Kit, Governor (13 Tooth Speedo) White (200-4R).....	1	81-90	54684BB	DK32412
686J	Cover, Governor (200, 200C).....	1	76-87	54686A	32707
VALVE BODIES					
740J	Valve Body (Premium) (Exc Grand National) (200-4R).....	1	81-90	54740-1	P32990M
VALVE BODY COMPONENTS					
741E	Spring, Anti-Stick Throttle Valve (200, 200C).....	1	76-87	106681A-3	6242CS
741E	Accumulator Assembly (.315" Valve, Sleeve, Plug, & 3 Springs) (200-4R).....	1	81-90	74741EBK	K61943A
741E	Accumulator Assembly (.330" Valve, Sleeve, Plug, & 3 Springs) (200-4R).....	1	81-90	74741EAK	K61943
741E	Accumulator Assembly (.341" Valve, Sleeve, Plug, & 3 Springs) (200-4R).....	1	81-90	74741EK	K61943B
741E	Throttle Valve Kit (.357" Valve & Sleeve).....	1	76-90	54741ANK	K32971
741E	Throttle Valve Kit (.390" Valve & Sleeve).....	1	76-90	54741AANK	K32971A
741E	Throttle Valve Kit (.430" Valve & Sleeve).....	1	76-90	54741ABNK	K32971B
747J	Plate, Valve Body (Code X) (200-4R).....	1	81-90	54747BE	N/A
747J	Plate, Valve Body (Square, Wide-U, Square, UVV) (200-4R).....	1	81-90	54747BB	N/A
MISCELLANEOUS COMPONENTS					
480F	Ball & Capsule, Input Shaft.....	1	81-90	54480A	32764
483	Cup Plug, Park Pawl (.375") (200, 200C).....	1	76-90	54483A	13970
861F	Snap Ring, Holds 4th Clutches In Case.....	1	81-90	54861B	32560
884D	Snap Ring, Holds Shell to Sun Gear.....	1	81-90	54884A	32733
894H	Snap Ring, Holds Front Planet to Output Shaft.....	1	81-90	54894A	32761
907E	Super Servo (Superior).....	1	81-90	54907BS	K32986S
908E	Pin, Servo Extendo Pin (Teckpak).....	1	76-90	T54908A	32875
908E	Pin, Servo (3 Ring).....	1	81-90	54908AC	32708C
908E	Pin, Servo (1 Wide Band).....	1	81-90	54908AD	32708
926J	Spring, 1-2 Accumulator (Steel Color).....	1	76-87	54926AA	N/A
926J	Spring, 1-2 Accumulator (Red).....	1	76-87	54926C	32706A
926J	Spring, 1-2 Accumulator (Plain, No Color).....	1	81-90	54926A	N/A
926J	Spring, 1-2 Accumulator (White).....	1	81-90	54926B	32891A
927J	Piston, 1-2 Accumulator.....	1	81-90	54927B	DK32985
937J	Piston, 3-4 Accumulator.....	1	81-90	74927	61985X
938J	Pin, 3-4 Accumulator.....	1	81-90	74938	D61985P
938J	Pin, 1-2 & 3-4 Accumulator (Oversized) (4 Per Kit).....	1	81-90	74938X	61985P
938J	Reamer Kit, 1-2 & 3-4 Accumulator (Oversized).....	1	81-90	74938XK	T-9157
977I	Return Spring, Low/ Reverse Clutch.....	1	76-90	54977A	32551
985C	Spring Guide, Direct Clutch.....	1	76-90	54985B	32737



NOTES

TH325(M32) TH325-4L(M57) w/L/U

ILL.	DESCRIPTION	QTY.	YEAR	PART NO.	REFERENCE NO.
DELUXE KITS (SUPER KITS) (1)					
008	325-4L	1	82-85	54008D	K3200E-R
COMPLIANCE KITS (CALIFORNIA KITS) (1)					
007	325.....	1	79-81	54007C	CK3200D-R
007	325-4L	1	82-85	54007D	CK3200E-R
MASTER OVERHAUL KITS (WITH STEELS) (1)					
006	325.....	1	79-81	54006C	K3200D
006	325-4L	1	82-85	54006D	K3200E
LESS STEEL KITS (1)					
004	325.....	1	79-81	54004C	K3200D-LS
004	325-4L	1	82-85	54004D	K3200E-LS
OVERHAUL KITS (W/ RINGS & SEALS) (1)					
002	325.....	1	79-81	54002C	K32900D
002	325-4L	1	82-85	54002D	K32900E
FILTER KITS (1)					
011	Filter Kit, 325	1	79-81	54011C	FK32710F
011	Filter Kit, 325-4L	1	82-85	54011D	FK32710E
<i>(1) - To order Kits with Fiber pan gaskets, add an "F" suffix</i>					
FILTERS					
010	325.....	1	79-81	54010C	32710F
010	325-4L	1	82-85	54010D	32710E
BANDS					
Prefix Key: B = Borg Warner, A = OEM (Exc BW), N = All Other New, R = Relined					
022	Intermediate Flex.....	1	79-85	54022A	32700F
BUSHINGS					
030	Bushing Kit, 325	1	79-81	54030C	K32901D
030	Bushing Kit, 325-4L	1	82-85	54030D	K32901E
034	Pump Body	1	79-81	44034	8005
034	Pump Body	1	82-85	54034A	32005
METAL CLAD SEALS					
070	Front (Converter)	1	79-81	44070	38151V
070	Front (Converter)	1	82-85	74070	61151C
FRICTION PLATES					
100	4th.....	2	82-85	54100B	32107
106	Forward & Direct.....	8-11	79-85	54106A	32103
114	Low & Reverse	5-6	79-85	54114A	32102A
116	Overrun	2	82-85	54116B	32108
STEEL PLATES					
120	4th.....	3	82-85	54120B	32109
126	Direct.....	3-5	79-85	54126A	32104
126	Forward	2-3	79-85	54126AA	32100
134	Low & Reverse	5-7	79-85	54134A	32101
136	Overrun	2	82-85	54136B	32110

TH325(M32) TH325-4L(M57) w/L/U

ILL.	DESCRIPTION	QTY.	YEAR	PART NO.	REFERENCE NO.
VALVE BODY RECALIBRATION KITS					
165	Shift Kit®, 325 (Transgo®).....	1	79-81	T54165C	K32908D
165	Shift Kit®, 325-4L (Transgo®)	1	82-85	T54165D	K32908E
SEALING RINGS					
175	Ring Kit, 325 (Teflon)	1	79-81	54175CT	K32903F
175	Ring Kit, 325-4L (Teflon)	1	82-85	54175DT	K32903E
THRUST WASHERS					
232	Thrust Washer Kit w/o Selectives	1	79-85	54200D	K32907D
BEARINGS					
201	Bearing Kit	1	79-85	54201A	K32907K
GASKETS & O-RINGS					
300	Gasket, Pan (Bottom) (Cork)	1	79-85	54300C	13900AX
300	Gasket, Pan (Bottom) (Fiber)	1	79-85	54300CF	13900AF
301	Gasket, Sprocket Cover (Cork)	1	79-81	54301C	13983X
301	Gasket, Sprocket Cover (Fiber)	1	79-81	54301CF	13983F
301	Gasket, Sprocket Cover (Cork)	1	82-85	54301D	13983AX
301	Gasket, Sprocket Cover (Fiber)	1	82-85	54301DF	13983AF
305	Gasket, Final Drive to Case	1	79-85	54305C	13354
311	O-Ring, Front Pump	1	79-85	34311G	13273
362	Seal Kit, Servo	1	79-85	54361AK	K32900-3
386	Plug Assembly w/ Seal, Low/ Reverse Clutch Housing.....	1	79-85	54386A	13969
386	Plug Assembly w/ Seal.....	1	79-85	54386BK	N/A
TECHNICAL MANUALS					
400	Tech Manual, 325-4L	1	82-85	54400D	32Y04
ELECTRICAL COMPONENTS					
411	Switch, High Pressure 1 Prong (Normally Closed).....	1	82-85	54411B	15D-112
425	Solenoid (TCC) (Universal)	1	82-85	84425	5R-148
444	Connector, Case (3 Prong)	1	82-85	74444A	25A-103
HARD PARTS					
Prefix Key: D = OEM, A = Aftermarket New, R = Remanufactured					
544	Plate, Pump	1	79-81	54544C	D32204
622	Shell, Input Drum (Hardened)	1	79-85	54622AH	32729H
632	Low/ Reverse Clutch Housing (Center Support)	1	79-85	54632A	32727
650	Sprag , Overdrive.....	1	82-85	54650D	32963
654	Sprag , Low Roller	1	79-85	54654A	32502AH
680	Governor, Gas	1	79-81	54680C	N/A
680	Governor, Gas	1	82-85	54680DG	N/A
680	Governor, Diesel.....	1	1981	54680CD	N/A
680	Governor, Diesel.....	1	82-85	54680D	32410F
700	Chain	1	79-81	54700C	32973
700	Chain	1	82-85	54700D	32973A
908	Pin, Servo (3 Groove).....	1	79-85	54908C	D32708C
908	Pin, Servo Extendo (Teckpak)	1	79-85	T54908A	32875
938	Pin, 1-2 & 3-4 Accumulator (Oversized) (4 Per Kit).....	1	79-85	74938X	61985P
938	Reamer Kit, 1-2 & 3-4 Accumulator (Oversized)	1	79-85	74938XK	T-9157
970	Wave Spring, Overrun Clutch Return.....	1	82-85	54970D	D32551A
977	Return Spring, Low/ Reverse Clutch	1	79-85	54977A	32551

TH325/325-4L

TH350/350C TH250C/375B

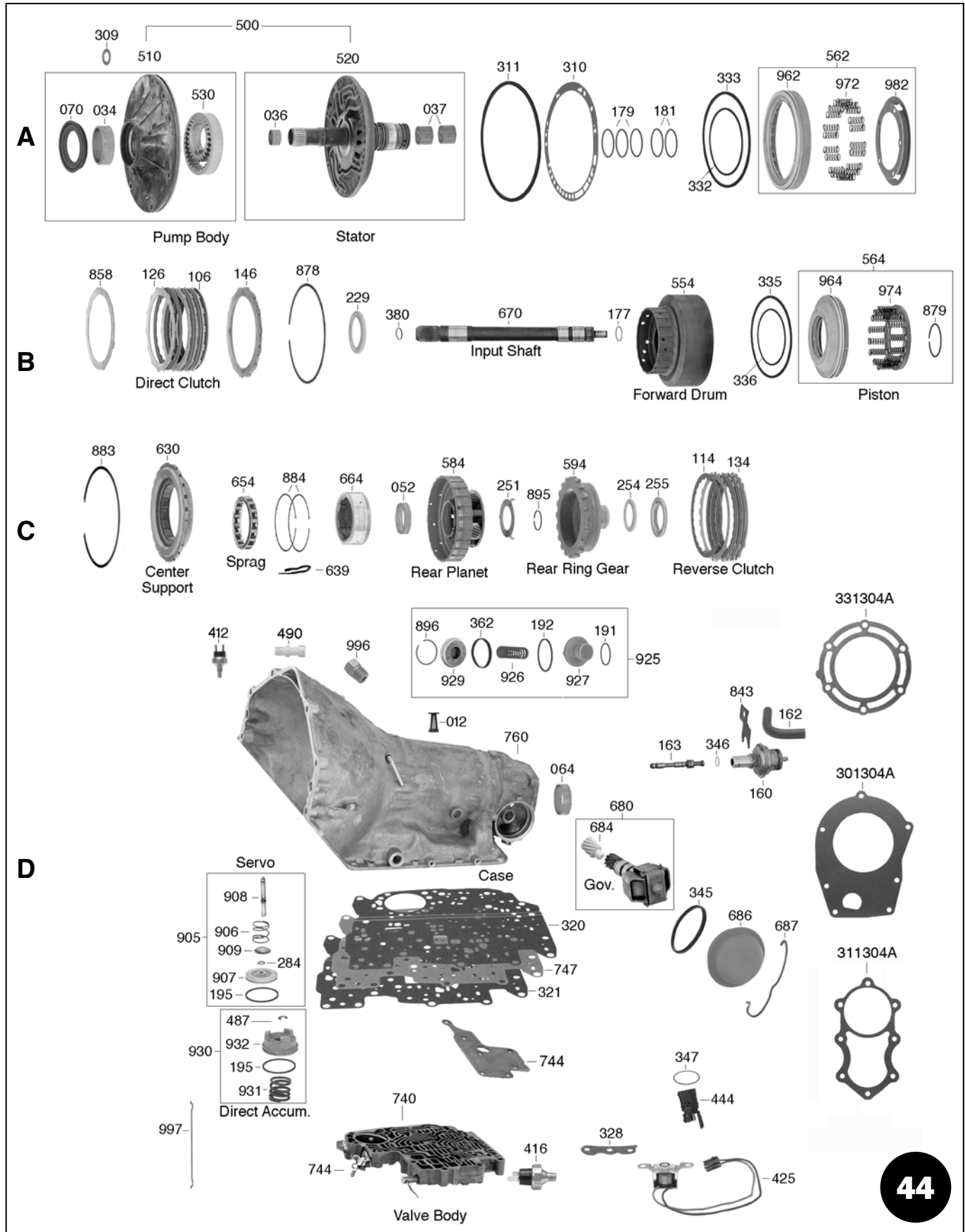

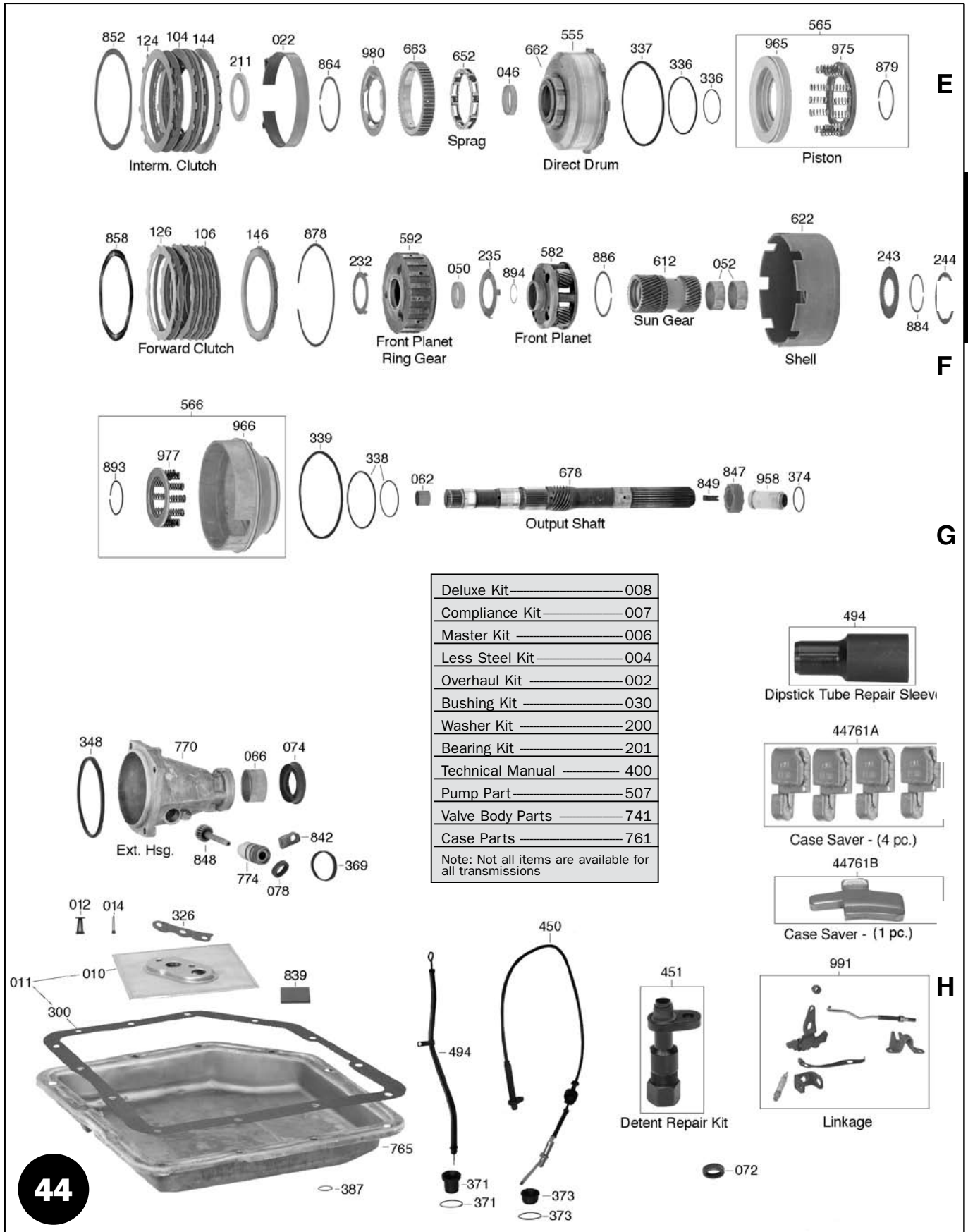

TH350/350C TH250C/375B



44010



44010A



44010B

Buick
Cadillac
Chevrolet
Chevrolet Trucks
GMC Trucks
Oldsmobile
Pontiac
Holden - Australia V8

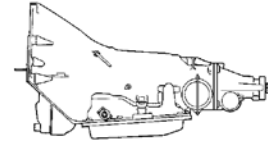

Rear Wheel Drive

ILL.	DESCRIPTION	QTY.	YEAR	PART NO.	REFERENCE NO.
DELUXE KITS (SUPER KITS) (1)					
008H	(Complete Ring Kit) 250, 350.....	1	69-79	44008A	K3500B-R
008H	(Complete Ring Kit) 250, 350, 350C.....	1	69-86	44008D	K3500F-R
008H	(Complete Ring Kit) 250C.....	1	80-86	44008H	K3500G-R
008H	(Complete Ring Kit) 350C.....	1	80-86	44008C	N/A
COMPLIANCE KITS (CALIFORNIA KITS) (1)					
007H	(Complete Ring Kit) 250, 350.....	1	69-79	44007A	CK3500B-R
007H	(Complete Ring Kit) 250, 350, 350C.....	1	69-86	44007D	CK3500F-R
007H	(Complete Ring Kit) 350C.....	1	80-86	44007C	N/A
MASTER OVERHAUL KITS (WITH STEELS) (1)					
006H	(Complete Ring Kit) 250, 350.....	1	69-79	44006A	K3500B
006H	(Complete Ring Kit) 250, 350, 350C.....	1	69-86	44006D	K3500F
006H	(Complete Ring Kit) 250C.....	1	80-86	44006H	K3500G
006H	(Complete Ring Kit) 350C.....	1	80-86	44006C	N/A
006H	(Short Ring Kit) 250, 350.....	1	69-79	44006	K3500C
006H	(Short Ring Kit) 350C.....	1	80-86	44006B	N/A
LESS STEEL KITS (1)					
004H	(Complete Ring Kit) 250, 350.....	1	69-79	44004A	K3500B-LS
004H	(Complete Ring Kit) 250, 350, 350C.....	1	69-86	44004D	K3500F-LS
004H	(Complete Ring Kit) 250C.....	1	80-86	44004H	K3500G-LS
004H	(Complete Ring Kit) 350C.....	1	80-86	44004C	N/A
004H	(Short Ring Kit) 250, 350.....	1	69-79	44004	K3500C-LS
004H	(Short Ring Kit) 350C.....	1	80-86	44004B	N/A
OVERHAUL KITS (W/ RINGS & SEALS) (1)					
002H	(Complete Ring Kit) 250, 250C, 350, 350C	1	69-86	44002D	K35900F
002H	(Complete Ring Kit) 250, 350.....	1	69-79	44002A	K35900B
002H	(Complete Ring Kit) 250C, 350C	1	80-86	44002C	N/A
002H	(Short Ring Kit) 250, 350.....	1	69-79	44002	K35900C
002H	(Short Ring Kit) 250C, 350C	1	80-86	44002B	N/A
GASKET & SEAL KITS (W/O RINGS & SEALS) (1)					
000H	250, 350.....	1	69-79	44000	K35900B-1
000H	250C, 350C	1	80-86	44000B	N/A
000H	250, 250C, 350, 350C (Combo).....	1	69-86	44000D	K35900F-1
FILTER KITS (1)					
011H	Filter Kit, Brass.....	1	69-86	44011	FK35710
011H	Filter Kit, Felt	1	69-86	44011A	FK35710D
011H	Filter Kit, Nylon.....	1	69-86	44011B	FK35710B
<p><i>(1) - To order Kits with Fiber pan gaskets, add an "F" suffix.</i></p>					

TH350/350C TH250C/375B

ILL.	DESCRIPTION	QTY.	YEAR	PART NO.	REFERENCE NO.
FILTERS					
010H	Filter, Brass	1	69-86	44010	35710
010H	Filter, Felt	1	69-86	44010A	35710D
010H	Filter, Nylon	1	69-86	44010B	35710B
012H	Screen, Oil Pump Pressure	1	69-86	44012	35711
014H	Screen, Governor	1-2	69-86	44014	35712
BANDS					
Prefix Key: B = Borg Warner, A = OEM (Exc BW), N = All Other New, R = Relined					
022E	Intermediate Single Wrap	1	69-86	44022	35700
022E	Intermediate Single Wrap (Heavy Duty)	1	69-86	44022HD	35700X
022E	Intermediate Double Wrap (250, 250C Only)	1	69-86	44022G	35700A
BUSHINGS					
030H	Bushing Kit	1	69-79	44030	K35901
030H	Bushing Kit	1	80-86	44030A	K35901
034A	Pump	1	69-86	44034	8005
036A	Stator (Front)	1	69-79	44036	35007
036A	Stator (Front)	1	80-86	44036B	35007A
037A	Stator (Rear)	2	69-86	44037	35003
046E	Direct Drum (Narrow) Babbitt	1	69-86	44046	35000A
046E	Direct Drum (Narrow) Bronze	1	69-86	44046B	35000
046E	Direct Drum (Wide, No Oil Grooves)	1	69-86	44046C	35000B
050F	Input Ring Gear (Babbitt)	1	69-86	44050	35006
052F	Sun Gear & Rear Planet	3	69-86	44052	35009
062G	Output Shaft Pilot (Bronze) (.500" Long)	1	69-79	44062	8004
062G	Output Shaft Pilot (Bronze) (.750" Long)	1	69-79	44062B	8004B
062G	Output Shaft Pilot (Plastic)	1	80-86	44062C	8004T
064D	Case	1	69-86	44064	35012
064D	Governor Bore (Use w/ T-0107 Repair Tool)	1	69-86	44064B	30104A
066H	Extension Housing (Babbitt)	1	69-86	44066	8008A
066H	Extension Housing (Bronze)	1	69-86	44066B	8008
METAL CLAD SEALS					
070A	Front	1	69-86	44070	38151V
072H	Linkage Shaft	1	69-86	44072	38511
074H	Rear (w/ Flange) (w/o Boot)	1	69-86	44074	8850B
075	Drive Shaft Yoke Seal (Teckpak)	1	69-86	T44075	T-9145R
075	Drive Shaft Yokes (qty 6) & Installation Tool (Teckpak)	1	69-86	T44075K	N/A
078H	Speed-O Shaft (Metal Clad)	1	69-86	44078	38511X
078H	Speed-O Shaft (Rubber, w/ Spring)	1	69-86	44078A	3991L
078H	Speed-O Shaft (Rubber, w/o Spring)	1	69-86	44078X	3991LS
FRICITION PLATES					
104E	Intermediate	2-3	69-86	44104	35102
104E	Intermediate (Hi-Performance) (Blue)	2-3	69-86	R44104HP	35102X
104E	Intermediate (Hi-Performance) (Red)	2-3	69-86	A44104HP	35102R
106B/F	Forward & Direct (Exc 250C)	6-9	69-86	44106	35103
106B/F	Forward & Direct (Hi-Performance) (Blue)	6-9	69-86	R44106HP	35103X
106B/F	Forward & Direct (Hi-Performance) (Red)	6-9	69-86	A44106HP	35103R
106B/F	Forward & Direct (250C Only)	6-9	80-86	44106B	35108
114C	Low & Reverse (Exc 250C)	4-5	69-86	44114	18506
114C	Low & Reverse (Hi-Performance) (Blue)	4-5	69-86	R44114HP	18506X
114C	Low & Reverse (Hi-Performance) (Red)	4-5	69-86	A44114HP	18506R
114C	Low & Reverse (250C Only)	4-5	80-86	74114	35109

TH350/350C

TH350/350C TH250C/375B

ILL.	DESCRIPTION	QTY.	YEAR	PART NO.	REFERENCE NO.
STEEL PLATES					
124E	Intermediate (.068")	2-3	69-86	44124	35104
124E	Intermediate (.068") (Kolene)	2-3	69-86	44124K	35104K
124E	Intermediate (.078") (Oversized)	AR	69-86	44124AX	35104X
124E	Intermediate (.089") (Oversized)	AR	69-86	44124X	N/A
126B/F	Forward & Direct (.068")	6-9	69-86	44126	35100
126B/F	Forward & Direct (.068") (Kolene)	6-9	69-86	44126K	35100K
126B/F	Forward & Direct (.088") (Oversized)	AR	69-86	44126X	35100X
134C	Low & Reverse (.068")	4-5	69-86	44134	35101
134C	Low & Reverse (.068") (Kolene)	4-5	69-86	44134K	35101K
134C	Low & Reverse (.080") (Oversized)	AR	69-86	44134X	35101X
N.I.	Steel Module	1	69-86	44139	N/A
PRESSURE PLATES					
Prefix Key: D = OEM, A = Aftermarket New, R = Remanufactured					
146B/F	Forward & Direct (.245"-.255")	1-2	69-86	44146	35715
146B/F	Forward & Direct (.275"-.285")	1-2	69-86	44146A	35714
MODULATORS					
160D	Single Red Stripe Adjustable	1	69-86	44160R	38820S
160D	Black & Red Stripe	1	69-86	44160B	35820H
160D	Dual Red Stripe	1	69-86	44160D	35820K
160D	Universal Dual Red Stripe	1	69-86	84160R	66820X
VALVE BODY RECALIBRATION KITS					
165H	Shift Kit®, 350/350C (Transgo®)	1	69-86	T44165	K35908
165H	Valve Body Kit, 350 (Superior)	1	69-86	S44165	35C01
165H	Valve Body Kit, 350 Hi-Performance (Superior)	1	69-86	S44165P	35C-HP
165H	Reprogramming Kit™, Non Lock-Up Heavy Duty & Competition (Transgo®)	1	69-86	T44171	350-1-2
165H	Reprogramming Kit™, w/ Lock-Up Heavy Duty & Competition (Transgo®)	1	69-86	T44171A	350C-1-2
165H	Reprogramming Kit™, Non Lock-Up Full Manual Control Stick Shift (Transgo®)	1	69-86	T44173	350-3
SEALING RINGS					
175H	Ring Kit (Short) (5 Pump Rings Only)	1	69-86	44175	K35903C
175H	Ring Kit (Complete)	1	69-86	44175A	K35903X
175H	Ring Kit (Complete) (Late) (Teflon)	1	74-86	44175BT	K35903T
179A	Pump Stator (Direct Clutch)	3	69-86	44179	35300
181A	Pump Stator (Forward Clutch)	2	69-86	44181	35301
191D	Intermediate Accumulator Piston (Inner)	1	69-86	44191	35302A
192D	Intermediate Accumulator Piston (Outer)	1	74-86	44192A	35303A
THRUST WASHERS					
200H	Washer Kit	1	69-79	44200	K35907
200H	Washer Kit	1	80-86	44200B	K35907A
200H	Washer Kit, Pump Shim Kits (6 Shims)	1	69-86	44200F	K35701
211E	Stator # 1 .066"	1	69-86	44211	35400B
211E	Stator # 2 .083"	1	69-86	44211A	35400
211E	Stator # 3 .100"	1	69-86	44211B	35400A
232F	Forward Drum to Hub	1	69-86	44232	35405
232F	Forward Drum to Hub (Plastic)	1	69-86	44232A	35405A
235F	Front Planet to Hub	1	69-86	44235	35403
244F	Shell to Inner Race	1	69-86	44244	35406
244F	Shell to Inner Race (Plastic)	1	69-86	44244A	35406A
251C	Rear Planet to Support	1	69-86	44251	35402

ILL.	DESCRIPTION	QTY.	YEAR	PART NO.	REFERENCE NO.
BEARINGS & RACES					
201H	Bearing Kit	1	69-86	44201A	K35907B
211E	Bearing, Stator	1	69-86	44211C	35400C
229B	Bearing, Direct Drum to Forward Drum	1	69-86	44229	35407
251C	Bearing, Rear Planet to Support	1	69-86	44251A	35402B
254C	Bearing, Rear Ring Gear to Case	1	69-86	44254	35408
SHIMS					
212	Pump, .005" (selective thickness and suffix below)	AR	69-86	44212A	35412
	.010"=A, .015"=B, .020"=C, .025"=D, .030"=E, .035"=F				
255	Rear, .010" (selective thickness and suffix below)	AR	69-86	44255	35404
	.020"=A, .030"=B, .035"=C, .040"=D, .045"=E				
GASKETS & O-RINGS					
300H	Gasket, Pan (Cork)	1	69-86	44300	13500X
300H	Gasket, Pan (Fiber)	1	69-86	44300F	13500F
309A	Gasket, Pump Bolt Washer	8	69-86	44309	13268A
310A	Gasket, Pump	1	69-86	44310	13531A
311A	O-Ring, Front Pump	1	69-86	44311	3877L
304D	Gasket, 203 4x4 Transfer Case to Adapter	1	69-86	301304A	13590
304D	Gasket, 205 4x4 Transfer Case to Extension Housing	1	69-86	311304	105-324A
304D	Gasket, 208, 241 4x4 Transfer Case to Extension Housing (6 Bolt)	1	69-86	331304A	105-320
320D	Gasket, Upper Valve Body (Non Lock-Up)	1	69-79	44320	13525
320D	Gasket, Upper Valve Body (Lock-Up)	1	80-86	44320A	13525B
321D	Gasket, Lower Valve Body (Non Lock-Up)	1	69-79	44321	13525A
321D	Gasket, Lower Valve Body (Lock-Up)	1	80-86	44321A	13525C
326H	Gasket, Filter	1	69-86	44326	13501
328D	Gasket, Solenoid	1	69-86	44328	N/A
332A	Lip Seal, Intermediate Clutch (Inner)	1	69-86	44332	N/A
333A	Lip Seal, Intermediate Clutch (Outer)	1	69-86	44333	N/A
336B	Lip Seal, Forward Clutch (Inner)	1	69-86	44336	13562
335B	Lip Seal, Forward Clutch (Outer)	1	69-86	44335A	N/A
336B	Lip Seal, Direct Clutch (Inner)	1	69-86	44336	13562
336B	Lip Seal, Direct Clutch (Center)	1	69-86	44336C	N/A
337E	Lip Seal, Direct Clutch (Outer)	1	69-86	44337	3679L
338G	Lip Seal, Low/ Reverse Clutch (Inner)	1	69-86	44338	3773L
339G	Lip Seal, Low/ Reverse Clutch (Outer)	1	69-86	44339	N/A
339G	Lip Seal, Low/ Reverse Clutch (Center)	1	69-86	44339C	13536
345D	O-Ring, Governor Cover	1	69-86	44345	13515
346D	O-Ring, Modulator	1	69-86	44369B	3410L
347D	O-Ring, Electrical Connector	1	80-86	44369B	3410L
348H	O-Ring, Extension Housing	1	69-86	44348	3896L
362D	O-Ring, Intermediate Accumulator Steel Cover	1	69-86	44362	13520
362D	O-Ring, Intermediate Accumulator Aluminum Cover	1	69-86	44362A	13520A
368	O-Ring, Speed-O Housing .750" OD	1	69-86	44369B	3410L
369	O-Ring, Speed-O Housing 2.000" OD (Purple)	1	69-86	44369A	3126L
371H	O-Ring, Filler Tube	1	69-86	44371A	3291L
371H	Boot, Filler Tube	1	69-86	44371B	13925
373H	O-Ring, Detent Cable	1	69-86	44373A	13580
373H	Boot, Detent Cable Seal	1	69-86	44373B	13580A
374	O-Ring, Output Shaft Sleeve to Slip-Yoke	1	69-86	44374B	N/A
380B	O-Ring, Input Shaft (350C)	1	69-86	44380	13917
N.I.	External Seal Kit (Cork)	1	69-86	44390	SK35900-2
N.I.	External Seal Kit (Fiber)	1	69-86	44390F	N/A
TECHNICAL MANUALS					
400H	Tech Manual, 350/350C	1	69-86	44400	35Y01

TH350/350C TH250C/375B

ILL.	DESCRIPTION	QTY.	YEAR	PART NO.	REFERENCE NO.
ELECTRICAL COMPONENTS					
416D	Switch, Governor Switch (40 PSI) Purple Stripe.....	1	80-86	44416A	N/A
416D	Switch, Governor Switch (50 PSI) White Stripe.....	1	80-86	44416D	15A-150
416D	Switch, Governor Switch (54 PSI) Blue Stripe.....	1	80-86	44416E	15A-152
416D	Switch, Governor Non-Grounding.....	1	80-86	44416G	15A-133
425D	Solenoid (No Wires in Connector) (2 Spades).....	1	80-86	44425	5D-104
425D	Solenoid (2 Wires in Connector) (1 Spade).....	1	80-86	44425D	5D-107
425D	Solenoid (2 Wires in Connector) (2 Spades).....	1	80-86	44425B	5D-106
425D	Solenoid (2 Wires in Connector) (3 Spades).....	1	80-86	44425G	5D-108
425D	Solenoid (2 Wires in Connector) (No Spades).....	1	80-86	44425A	5D-105
HARD PARTS					
Prefix Key: D = OEM, A = Aftermarket New, R = Remanufactured					
PUMPS					
500A	Pump, 350 Bearing Type (5 Ring Stator).....	1	69-79	44500A	N/A
500A	Pump, 350 Bearing Type (6 Ring Stator).....	1	69-79	44500B	N/A
500A	Pump, 350 Washer Type.....	1	69-79	44500	35200
500A	Pump, 350C Lock-Up.....	1	80-86	44500C	35200C
510A	Pump Body, 350.....	1	L69-79	44510A	35200Z
520A	Stator, 350 Washer Type.....	1	69-79	44520	35200X
PUMP COMPONENTS					
530A	Pump Gears (.721").....	1	69-79	44530A	K35201A
530A	Pump Gears (.723").....	1	69-79	44530AA	K35201C
530A	Pump Gears (.725").....	1	69-79	44530AB	K35201
530A	Pump Gears (.727").....	1	69-79	44530AC	K35201B
530A	Pump Gears (.841").....	1	80-86	44530AD	K35201D
530A	Pump Gears (.843").....	1	80-86	44530AE	K35201F
530A	Pump Gears (.845").....	1	80-86	44530AG	K35201G
DRUMS & HUBS					
554B	Forward (w/o Input Shaft) (350, 350C Only).....	1	69-86	44554	35733
555E	Direct w/o Sprag (350, 350C Only).....	1	69-86	44555	35726
565E	Piston Kit, Direct Drum (5 Clutch).....	1	69-86	44565	N/A
566G	Piston Kit, Low/ Reverse Clutch (5 Clutch).....	1	69-86	44566	N/A
PLANETS					
582F	Front Washer Type.....	1	69-86	44582	35747
582F	Front Bearing Type.....	1	69-86	44582A	35747A
584C	Rear Low/ Reverse.....	1	69-86	44584	35730
592F	Ring Gear, Front Planet (Washer Type).....	1	69-86	44592	35748
592F	Ring Gear, Front Planet (Bearing Type).....	1	69-86	44592A	35748A
594C	Ring Gear, Rear Planet (Washer Type).....	1	69-86	44594	35749
594C	Ring Gear, Rear Planet (Bearing Type).....	1	69-86	44594A	N/A
SUN GEARS, SHELLS & SUPPORTS					
622F	Shell, Driving (Uses .210" Thick Race # 243).....	1	70-86	44622A	35728A
631C	Center Support Assembly.....	1	69-86	44631	35727
639C	Clip, Low & Reverse (Center Support) (Anti-Clunk Spring).....	1	69-86	74639	61915
SPRAGS					
652E	Sprag, Intermediate.....	1	69-86	44652	35502H
654C	Sprag, Low/ Reverse.....	1	69-86	44654	35503H
663E	Outer Race, Intermediate Sprag (Heavy Duty).....	1	69-86	44663HD	35429H
664C	Inner Race, Low/ Reverse Sprag.....	1	69-86	44664	35530

ILL.	DESCRIPTION	QTY.	YEAR	PART NO.	REFERENCE NO.
SHAFTS					
670B	Input Shaft (Bushing Type)	1	69-79	44670A	35731
670B	Input Shaft (Lock-Up).....	1	80-86	44670C	35731B
678G	Output Shaft, 9 5/8" Long (4wd)	1	80-86	44678C	35738C
678G	Output Shaft, 15 1/2" Long	1	69-86	44678	N/A
678G	Output Shaft, 18 1/2" Long	1	69-86	44678A	N/A
GOVERNORS					
680D	Governor.....	1	69-86	44680	35410
681D	Governor Kit, Springs & Weights (Superior)	1	69-86	44681-4K	K61931S
684D	Gear, Governor Driven Gear Kit	1	69-86	44684	K35411
686D	Cover, Governor	1	69-86	44686	61932
687D	Clip, Governor Cover.....	1	69-86	74687	61956
VALVE BODY COMPONENTS					
740D	Valve Body (350, 350C)	1	69-80	44740	N/A
741H	Check Ball, Valve Body (Steel) (1/4").....	4	69-86	44741-5	13924S
741H	Check Ball, Valve Body (Viton) (1/4") (can use 76741A-5)	4	69-86	44741V-5	N/A
N.I.	Repair Kit, Fixes 5 Valve Body Plate Holes Most w/ 1/4" Ck Balls (Teckpak)	1	69-86	VB-101	96-350VB
CASES & HOUSINGS					
760D	Case, 350 BPO	1	69-79	44760A	N/A
760D	Case, 350 Chevy.....	1	69-79	44760	N/A
760D	Case, 350C Chevy	1	80-86	44760E	N/A
765H	Pan, Shallow (Chrome)	1	69-86	44765C	TPC-350
765H	Pan, Deep (Chrome).....	1	69-86	44765D	TPC-350D
MISCELLANEOUS COMPONENTS					
761H	Case Saver (4 Piece).....	1	69-86	44761A	K35790A
761H	Case Saver (1 Piece).....	1	69-86	44761B	35790
761H	Case Fix, Center Support, Wide Sprag Type All Years	1	69-86	74761D	K61995G
774H	Speed-O Housing, 7/8" Steel (Bullet).....	1	69-86	44774	35227
774H	Gear Housing, For 34-39T Speedo Driven Gear (Plastic)	1	69-86	44774BA	35227A
774H	Gear Housing w/ Seals, For 34-39T Speedo Driven Gear (Aluminum)	1	69-86	44774BAM	N/A
774H	Gear Housing w/ Seals, For 40-43T Speedo Driven Gear (Aluminum)	1	69-86	44774BM	N/A
842	Bracket, Holds Large Speed-O-Housing In Place.....	1	69-86	74842	N/A
843D	Bracket, Modulator (Bolts to Extension Housing) (Z Shaped Repair Bracket)	1	69-86	44843C	35795
846	Bracket, 4wd (Allows 6 Bolt Dust Cover to Bolt to a 4 Bolt Case)	1	69-86	44846	K35996
878B	Snap Ring, Holds Fwd & Dir Pressure Plate In Drum	2	69-86	44878	35551
883C	Snap Ring, Holds Center Support to Case.....	1	69-86	44883	35552
884C	Snap Ring, Holds Sprag to Center Support	2	69-86	44884	35560
905D	Kit, Intermediate Servo Sleeve	1	69-86	44905K	K35986S
926D	Spring, Intermediate Accumulator (Orange)	1	69-86	44926	35706
933	Pin Kit, Direct Accumulator.....	1	69-86	44933AK	35707P
933	Pin Kit w/ Reamer, Direct Accumulator.....	1	69-86	44933BK	T-9134
997D	Detent Wire Link.....	1	69-86	44997-7	35933
Tool	Governor Bore Repair Tool (Uses 30104A)	1	69-86	T-0107	T-0107
Tool	Governor Bore Repair Driver	1	69-86	T-0107-D	T-0107-D
N.I.	Transmission Changeover Kit, 700-R4 to 350 (2wd).....	1	69-86	7-35B	7-35BT
N.I.	Transmission Changeover Kit, 700-R4 to 350 (4wd).....	1	69-86	7-35A	7-35AT

TH400(M40) 3L80 TH375 - TH475 3L80HD

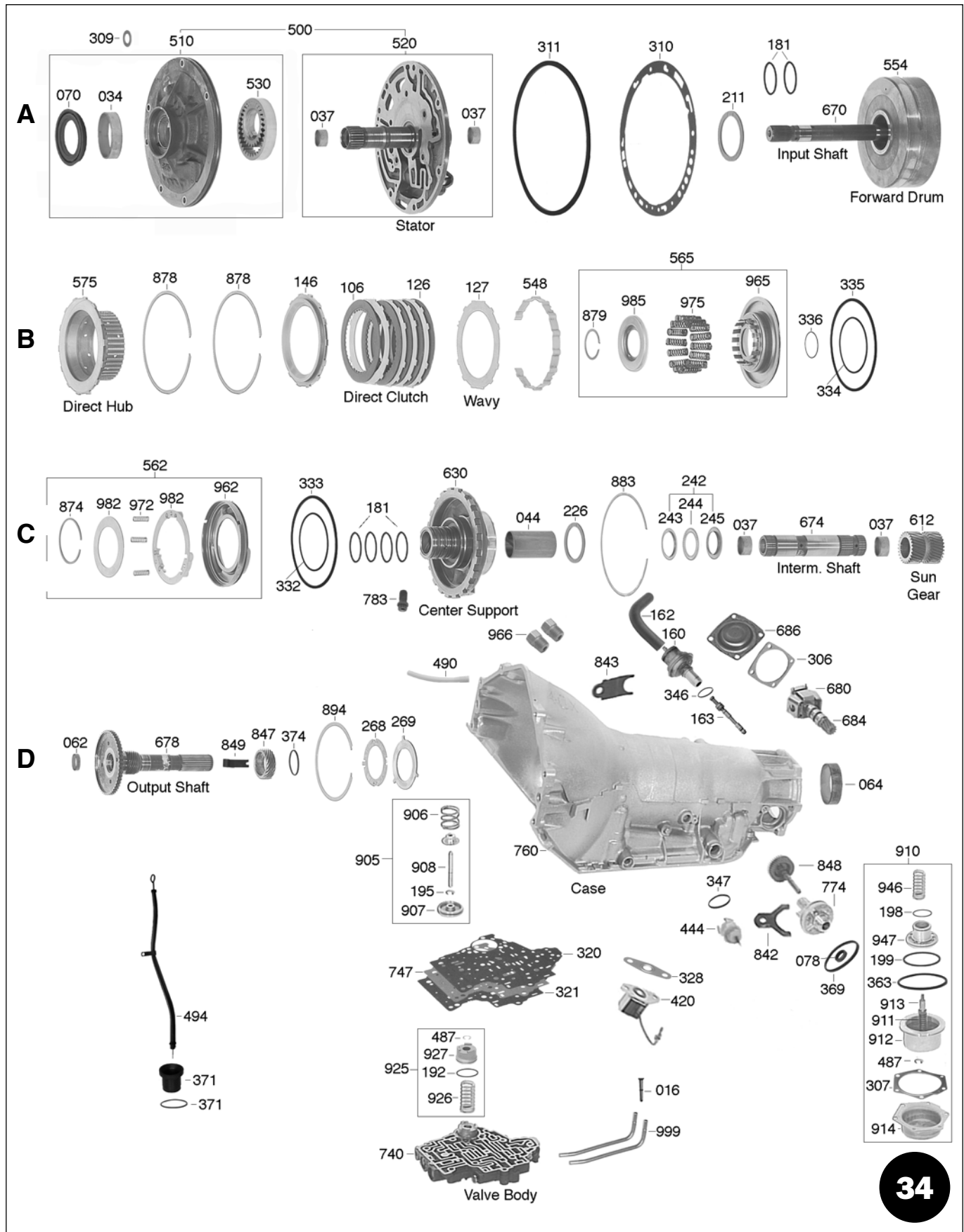

TH400(M40) 3L80 TH375 - TH475 3L80HD

TH400/3L80

E

335, 336, 334, 564, 964, 974, 984, 877, 547, 127, 106, 128, 232, 574, 235, Forward Hub

F

555, Direct Drum, 652, Interm. Sprag, 663, 694, 886, 022, Front Band, 873, 144, 104, 124, Intermediate Clutch, 125, Wavy, 872

G

654, Rear Sprag, 980, 053, 582, Front Planet, 024, Rear Band, 476, Silencer Ring, 268, 584, Rear Planet, 672, Main Shaft, 249, 250, 251, 252, 594, Rear Ring Gear, 256, 253, 254, 255, 889

H

305, 770, 066, 074, Ext. Hsg., 368, 495, 789, 010-011, 839, 790, 300, 765, Pan, 991, 994, 072, 991-1, 991-3, 995, 483, 0-387, 331304A, 351304

Deluxe Kit	008
Compliance Kit	007
Master Kit	006
Less Steel Kit	004
Overhaul Kit	002
Bushing Kit	030
Washer Kit	200
Bearing Kit	201
Technical Manual	400
Pump Part	507
Valve Body Parts	741
Case Parts	761

Note: Not all items are available for all transmissions

TH400(M40) 3L80 TH375 - TH475 3L80HD

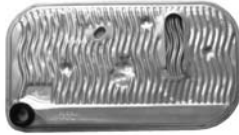
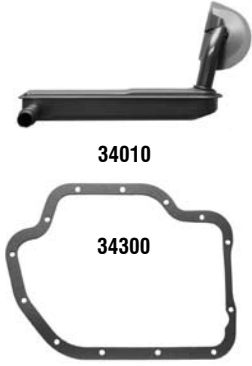

Buick	91
Cadillac	
Chevrolet	
Chevrolet & GMC Trucks	
Vans G10 w/5.0L	
Oldsmobile	64-Up
Pontiac	
Willys	
Bentley	
Ferrari 400GT	
Holden (Some)	
Jaguar V12	
Rolls Royce	

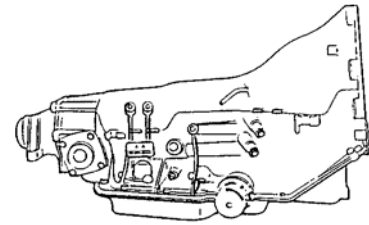

Rear Wheel Drive

ILL.	DESCRIPTION	QTY.	YEAR	PART NO.	REFERENCE NO.
DELUXE KITS (SUPER KITS) (1)					
008H	400 (Complete Ring Kit).....	1	65-98	34008A	K3400D-R
COMPLIANCE KITS (CALIFORNIA KITS) (1)					
007H	400 (Complete Ring Kit).....	1	65-98	34007A	CK3400D-R
MASTER OVERHAUL KITS (WITH STEELS) (1)					
006H	400 (Short Ring Kit).....	1	65-98	34006	SK3400D
006H	400 (Complete Ring Kit).....	1	65-98	34006A	K3400D
LESS STEEL KITS (1)					
004H	400 (Short Ring Kit).....	1	65-98	34004	SK3400D-LS
004H	400 (Complete Ring Kit).....	1	65-98	34004A	K3400D-LS
OVERHAUL KITS (W/ RINGS & SEALS) (1)					
002H	400 (Short Ring Kit).....	1	65-98	34002	SK34900D
002H	400 (Complete Ring Kit).....	1	65-98	34002A	K34900D
GASKET & SEAL KITS (W/O RINGS & SEALS) (1)					
000H	400.....	1	65-98	34000	K34900D-1
FILTER KITS (1)					
011H	Tube.....	1	64-E67	34011	FK34661
011H	Flat (Felt).....	1	L67-98	34011A	FK34661A
011H	Flat (Brass).....	1	L67-98	34011B	FK34661S
<i>(1) - To order Kits with Fiber pan gaskets, add an "F" suffix.</i>					
FILTERS					
010H	Tube.....	1	64-E67	34010	34661
010H	Flat (Felt).....	1	L67-98	34010A	34661A
010H	Flat (Brass).....	1	L67-98	34010B	34661S
016D	Screen, Governor (Tapered).....	1	65-98	54016B	34713
495H	Filter Pipe Intake, Deep Pan Type (Plastic).....	1	65-98	34495	34995B
495H	Filter Pipe Intake, Shallow Pan Type (Plastic).....	1	65-98	34495A	34995
BANDS					
Prefix Key: B = Borg Warner, A = OEM (Exc BW), N = All Other New, R = Relined					
022F	Front (1" Wide) (Used w/ Front Servo Piston w/ 2.530" Pin).....	1	65-98	34022	34325
022F	Front (1" Wide) (Used w/ Front Servo Piston w/ 2.530" Pin) (Kevlar).....	1	65-98	34022K	N/A
022F	Front (1" Wide) (Used w/ Front Servo Piston w/ 2.530" Pin) (Heavy Duty).....	1	65-98	34022HD	34325X
022F	Front (1 1/4" Wide) (Used w/ Front Servo Piston w/ 2.730" Pin).....	1	65-98	34022E	34325B
024G	Rear (Reverse).....	1	65-98	34024	34510-RL
024G	Rear (Reverse) (Retros All).....	1	65-98	34024E	B34510

TH400(M40) 3L80 TH375 - TH475 3L80HD

ILL.	DESCRIPTION	QTY.	YEAR	PART NO.	REFERENCE NO.
BUSHINGS					
030H	Bushing Kit (Complete)	1	65-98	34030	K34903
030H	Bushing Kit, w/o Center Support Bushing	1	65-98	34030A	N/A
034A	Pump.....	1	65-98	44034	8005
037A	Stator Support	1	65-98	34037	34002
037A	Sun Gear Shaft (Front & Rear)	2	65-98	34037	34002
044C	Center Support.....	1	65-98	34044	34003
053G	Front Planet.....	1	65-98	34053	34008
062D	Output Shaft (.680" Wide)	1	65-74	34062	34004
062D	Output Shaft (.410" Wide)	1	74-98	34062B	34004A
N.I.	Governor Bore Bushing	1	65-98	44064B	30104A
064D	Case	1	65-98	34064	34006
064D	Case ("No Walk-Out")	1	65-98	34064BA	N/A
064D	Case Repair w/ Bearing & Shims	1	65-98	34064C	N/A
066H	Extension Housing (1.795" OD) 1 1/4" Long	1	65-98	34066A	4008
066H	Extension Housing (1.995" OD) 1 1/2" Long	1	65-98	34066	34005A
METAL CLAD SEALS					
070A	Front.....	1	65-98	44070	38151V
072	Linkage Shaft.....	1	65-98	44072	38511
074H	Rear (2.380" OD).....	1	65-98	44074	8850B
074H	Rear (2.500" OD).....	1	65-98	36074	4743C
074H	Rear (2.700" OD).....	1	65-98	34074	34743D
074H	Rear (2.874" OD) (Motor Homes).....	1	65-98	34074EA	34743E
078D	Speed-O Shaft (w/ Spring)	1	65-98	44078A	3991L
078D	Speed-O Shaft (w/o Spring)	1	65-98	44078X	3991LS
FRICTION PLATES					
104F	Intermediate (Smooth)	3	65-98	34104	34404
104F	Intermediate (Waffle).....	3	65-98	34104HD	34404C
104F	Intermediate (Hi-Performance) (Blue).....	3	65-98	R34104HP	34404X
104F	Intermediate (Hi-Performance) (Red).....	3	65-98	A34104HP	34404R
106B/E	Forward & Direct (Smooth)	10	65-98	34106	34304
106B/E	Forward & Direct (Radial)	10	65-98	34106G	34304A
106B/E	Forward & Direct (Waffle).....	10	65-98	34106HD	34304W
106B/E	Forward & Direct (Thin .060") (Red)	10	65-98	A34106AH	34304RX
106B/E	Forward & Direct (Hi-Performance) (Blue).....	10	65-98	R34106HP	34304X
106B/E	Forward & Direct (Hi-Performance) (Red).....	10	65-98	A34106HP	34304R
STEEL PLATES					
124F	Intermediate (.100")	3	65-98	34124	34405
124F	Intermediate (.100") (Kolene)	3	65-98	34124K	34405K
124F	Intermediate (.076") (Kolene)	3	65-98	34124H	34405AK
125F	Intermediate (.070") (Waved)	1	65-98	34125	34420
126B	Direct (.090").....	4	65-98	34126A	34305C
126B	Direct (.090") (Kolene)	4	65-98	34126D	34305CK
126B	Direct (.060").....	AR	65-98	34126B	34305X
128E	Forward (.077")	5	65-98	34128	34305A
128E	Forward (.077") (Kolene).....	5	65-98	34128B	34305AK
128E	Forward (.060")	AR	65-98	34126B	34305X
127B/E	Forward & Direct (.060") (Waved)	1	65-98	34127	34305B
127B/E	Forward & Direct (.054") (Dished)	1	65-98	34127D	34305D
N.I.	Friction Kit, Intermediate (.061") (Hi-Perf) (5 Per Kit)	1	65-98	A34104AHPK	N/A
N.I.	Friction & Steel Kit, Intermediate (.080") (Hi-Perf).....	1	65-98	A34104PPK	N/A
N.I.	Steel Module.....	1	65-98	34139	N/A

TH400/3L80

TH400(M40) 3L80

TH375 - TH475 3L80HD

ILL.	DESCRIPTION	QTY.	YEAR	PART NO.	REFERENCE NO.
PRESSURE PLATES					
Prefix Key: D = OEM, A = Aftermarket New, R = Remanufactured					
144F	Intermediate Clutch	1	65-98	34144	N/A
146B	Direct Clutch	1	65-98	34146	34421
MODULATORS					
160D	Single Red Stripe Adjustable	1	65-98	44160R	38820S
160D	Black & Red Stripe	1	65-98	44160B	35820H
160D	Dual Red Stripe	1	65-98	44160D	35820K
160D	Mechanical Modulator (Controlled By 700-R4 Type Cable) (Teckpak)	1	65-98	T34160	40M
162D	Hose, Modulator (Elbow)	1	65-98	44162	13566
924	Vacuum Regulator Pump, To Change Diesel 700-R4 to 400 (Non Computer)	1	65-98	74924A	N/A
924	Vacuum Regulator Pump, To Change Diesel 700-R4 to 400 (w/ Computer)	1	65-98	74924E	N/A
VALVE BODY RECALIBRATION KITS					
165H	Shift Kit®, 400 (Transgo®)	1	65-98	T34165	K34908
165H	Valve Body Kit, 400 (Superior)	1	65-98	S34165	34C01
165H	Reverse Cushion Kit, Corrects Harsh/Bang Reverse (Transgo®)	1	65-98	T34165A	K34908B
165H	Reprogramming Kit™, Heavy Duty & Competition (Transgo®)	1	65-98	T34169	400-1-2
165H	Reprogramming Kit™, Pro Race Kit (Transgo®)	1	65-98	T34171	N/A
165H	Reprogramming Kit™, Competition Only, Stick Shift Full Manual Control (Transgo®) ..	1	65-98	T34173	400-3
SEALING RINGS					
175H	Ring Kit (Short) (6 Rings) (Metal) (Add T Suffix Teflon)	1	65-98	34175	N/A
175H	Ring Kit (Complete) (Metal) (Add T Suffix Teflon)	1	65-98	34175A	K34901A
181A	Stator (Metal) (Add T Suffix Teflon)	2	65-98	34181	34406
181A	Center Support (Metal) (Add T Suffix Teflon)	4	65-98	34181	34406
192D	Front Accumulator Piston (Metal) (Outer)	1	65-98	34192	34711
195D	Front Servo Piston (Metal) (Add T Suffix Teflon)	1	65-98	34192	34711
198D	Rear Accumulator (Inner) (Metal)	1	65-91	34198A	34710D
199D	Rear Accumulator (Outer) (Metal)	1	65-70	34199	N/A
199D	Rear Accumulator (Outer) (Metal) (Add T Suffix Teflon)	1	71-91	34199A	34712A
THRUST WASHERS					
200H	Washer Kit	1	65-98	34200	K34907
211A	Stator .062"	1	65-98	34211	34208
211A	Stator .073"	1	65-98	34211A	34208A
211A	Stator .084"	1	65-98	34211B	34208B
211A	Stator .095"	1	65-98	34211C	34208C
211A	Stator .106"	1	65-98	34211D	34208D
211A	Stator .117"	1	65-98	34211E	34208E
211A	Stator .128"	1	65-98	34211G	34208F
226C	Center Support to Front Planet (Metal)	1	65-98	34226	34401
226C	Center Support to Front Planet (Plastic)	1	65-98	34226A	N/A
232E	Forward Drum to Forward Hub	1	65-98	34232	34339
235E	Forward Hub to Direct Drum	1	65-98	34235	34301
235E	Forward Hub to Direct Drum (Plastic)	1	65-98	34235A	N/A
235E	Forward Hub to Direct Drum (.078") Oversized	1	65-98	34235-078	34301C
235E	Forward Hub to Direct Drum (.094") Oversized	1	65-98	34235-094	34301D
268G	Front Planet to Rear Planet (4 Tang, Metal)	1	65-98	34268	34501A
268G	Front Planet to Rear Planet (4 Tang, Plastic)	1	65-98	54244A	32406A
268D	Output Shaft to Case (4-Tang) (Metal)	1	65-98	34268	34501A
269D	Output Shaft to Case .076" (3-Tang)	1	65-98	34269	34601
269D	Output Shaft to Case .084" (3-Tang)	1	65-98	34269A	34601A
269D	Output Shaft to Case .092" (3-Tang)	1	65-98	34269B	34601B

TH400(M40) 3L80 TH375 - TH475 3L80HD

ILL.	DESCRIPTION	QTY.	YEAR	PART NO.	REFERENCE NO.
THRUST WASHERS (Cont.)					
269D	Output Shaft to Case .100" (3-Tang)	1	65-98	34269C	34601C
269D	Output Shaft to Case .108" (3-Tang)	1	65-98	34269D	34601D
269D	Output Shaft to Case .116" (3-Tang)	1	65-98	34269E	34601E
270	Case Saver (3 Tang Washer Replacement)	1	65-98	34270T	34601T
BEARINGS & RACES					
201H	Bearing Kit	1	65-98	34201A	K34907B
242C	Bearing w/ Race, Center Support to Sun Gear	1	65-98	34242K	34920
249G	Bearing w/ Race, Sun Gear to Rear Ring Gear	1	65-98	34249K	34921
250G	Race, Sun Gear to Rear Ring Gear (Front)	1	65-98	34250	34403
252G	Shim, Under Race # 252 to Reduce End Play (10 Per Kit)	1	65-98	34252S	34412
252G	Shim, Output Shaft (.005")	1	65-98	34270	34413
256G	Bearing w/ Race, Rear Ring Gear to Output Shaft	1	65-98	34256K	34922
066H	Bearing, Extension Housing (Heavy Duty Application)	1	65-98	34271A	34976
GASKETS & O-RINGS					
300H	Gasket, Pan (Cork)	1	65-98	34300	3893LX
300H	Gasket, Pan (Fiber)	1	65-98	34300F	3893F
305H	Gasket, Extension Housing	1	65-98	34305	13271
304H	Gasket, 231 Transfer Case to Extension Housing	1	88-98	351304	13595
304H	Gasket, 241 & 208 Transfer Case to Extension Housing	1	88-98	331304A	105-320
304H	Gasket, 205 Transfer Case to Extension Housing	1	74-98	311304	105-324A
306D	Gasket, Governor Cover	1	65-98	34306	3914D
307D	Gasket, Rear Servo Cover	1	65-98	34307	3916L
309A	Gasket, Pump Bolt Washer	6-8	65-98	44309	13268A
310A	Gasket, Front Pump	1	65-98	34310	3994L
311A	O-Ring, Front Pump	1	65-98	44311	3877L
312	O-Ring, Pump Bolt	1	88-98	34312	N/A
320D	Gasket, Case to Spacer Plate (6 Check Ball Type)	1	65-E87	34320	3993L
320D	Gasket, Case to Spacer Plate (7 Check Ball Type)	1	L87-98	34320A	13824
321D	Gasket, Valve Body to Spacer Plate (6 Check Ball Type)	1	65-E87	34321	N/A
321D	Gasket, Valve Body to Spacer Plate (7 Check Ball Type)	1	L87-98	34321A	13823
328D	Gasket, Valve Body Detent Solenoid	1	65-98	34328	N/A
332C	Lip Seal, Intermediate Clutch (Inner)	1	65-98	34332	N/A
332C	Lip Seal Set, Intermediate Clutch	1	65-98	34332K	N/A
333C	Lip Seal, Intermediate Clutch (Outer)	1	65-98	34333	3962L
334B	Lip Seal, Forward/ Direct Clutch (Center) (Medium)	1	65-98	34334C	N/A
334B	Lip Seal, Forward Clutch (Center, Bevel Cut)	1	65-98	34334CA	N/A
335B	Lip Seal, Forward/ Direct Clutch (Outer)	1	65-98	34335	3643L
336B	Lip Seal, Forward/ Direct Clutch (Inner)	1	65-98	34336	N/A
363D	Seal, Rear Servo Piston	1	65-98	34363	N/A
368	O-Ring, Filter Pick-Up Tube	1	65-98	12368A	3547L
368	O-Ring, Modulator & Case Connector	2	65-98	44369B	3410L
369D	O-Ring, Speed-O-Housing	1	65-98	34369A	13582
371D	O-Ring, Filler Tube	1	65-98	44371A	3291L
371D	Boot, Filler Tube	1	65-98	44371B	13925
N.I.	External Seal Kit	1	65-98	34390	SK34900-2
TECHNICAL MANUALS					
400H	Tech Manual	1	65-98	34400	34Y01
ELECTRICAL COMPONENTS					
414	Switch, Spark Control	1	65-98	34414	15A-100
420D	Solenoid, Valve Body Detent	1	65-82	34420	5A-100
436	Speed Sensor, Vehicle (VSS)	1	85-Up	34436T	20D-211

TH400/3L80

TH400(M40) 3L80

TH375 - TH475 3L80HD

ILL.	DESCRIPTION	QTY.	YEAR	PART NO.	REFERENCE NO.
ELECTRICAL COMPONENTS (Cont.)					
444D	Connector, 1 Prong (Small OD).....	1	1964	34444	5A-101
444D	Connector, 1 Prong (Large OD).....	1	68-98	34444A	5A-101B
444D	Connector, 2 Prong w/ Variable Pitch (Large OD)	1	65-67	34444B	5A-101A
444D	Connector, 2 Prong w/o Variable Pitch (w/ Insulator).....	1	70-82	34444C	5A-102
SILENCER RINGS					
476G	Silencer Ring, Output Carrier .177"	1	69-80	34476	34999
476G	Silencer Ring, Output Carrier .170"	1	73-98	34476E	34999A
HARD PARTS					
Prefix Key: D = OEM, A = Aftermarket New, R = Remanufactured					
PUMPS					
500A	Pump, 6 Bolt (Body Cast # 895, Stator Cast # 896).....	1	71-98	34500	34200C
500A	Pump, 8 Bolt (Body Cast # 895, Stator Cast # 896).....	1	65-98	34500A	34200B
510A	Pump Body & Gears, Universal.....	1	71-98	A34510	34200CN
PUMP COMPONENTS					
529A	Stator Shaft Support	1	65-98	34529	34983
530A	Pump Gears, .727"	1	65-98	44530AC	K35201B
507H	Boost Valve Kit, Reverse (w/ O-Rings).....	1	65-98	34507RK	K34978
507H	Boost Valve Kit, Reverse (Factory Style)	1	65-98	34507RCK	K34978D
507H	Plug, End For Pressure Valve (10 Per Bag).....	1	65-98	34507P-6A	N/A
507H	Pressure Regulator Valve Kit (Uses Sealing Rings 34507PK-1).....	1	65-98	34507PK	K34979
507H	Pressure Regulator Shim.....	1	65-98	34507S	N/A
507H	Sealing Rings, Fits 34507PK (Bag of 25)	1	65-98	34507PK-1	N/A
507H	O-Rings, Fits 34507PK (Bag of 25)	1	65-98	ORMK-9	N/A
DRUMS & HUBS					
554A	Forward	1	65-98	34554	34832
555F	Direct (5 Clutch No Check Ball) (Smooth Cam).....	1	65-98	34555	34836
555F	Direct (5 Clutch w/ Check Ball) (Lug Cam).....	1	65-98	34555A	N/A
555F	Direct (6 Clutch w/ Check Ball) (Lug Cam).....	1	65-98	34555C	N/A
555F	Direct (6 Clutch No Check Ball) (Lug Cam).....	1	65-98	34555CA	34838
562C	Piston Kit, Intermediate Clutch (Aluminum).....	1	65-98	34562	N/A
565B	Piston Kit, Direct (5 Clutch) (Aluminum No Check Ball) (Cast # 8625931).....	1	65-98	34565B	N/A
565B	Piston Kit, Direct (5 Clutch) (Aluminum w/ Check Ball)	1	65-98	34565	N/A
565B	Piston Kit, Direct (6 Clutch) (Aluminum w/ Check Ball)	1	65-98	34565C	N/A
574E	Clutch Hub, Forward Clutch.....	1	65-98	34574	34946
575B	Clutch Hub, Direct Clutch	1	65-98	34575	34947
PLANETS					
582G	Front (Angled Teeth) (No Tab Roller Style Sprag)	1	67-98	34582A	34972
582G	Front (Angled Teeth) (8 Tab Roller Style Sprag)	1	67-98	34582AA	34972
582G	Front (Straight Teeth).....	1	65-98	34582S	34972A
584G	Rear (Angled Teeth 0.5" Parking Lugs).....	1	65-98	34584	34880
584G	Rear (Angled Teeth 1.5" Parking Lugs).....	1	65-98	34584A	N/A
584G	Rear (Straight Teeth 0.5" Parking Lugs).....	1	65-98	34584S	N/A
584G	Rear (Straight Teeth 1.5" Parking Lugs).....	1	65-98	34584SA	N/A
594G	Ring Gear, Rear Planet (Angled Teeth).....	1	65-98	34594	N/A
594G	Ring Gear Kit w/ Mainshaft Hollow Type (Angled Teeth)	1	65-98	34594K	34974
594G	Ring Gear, Rear Planet (Straight Teeth).....	1	65-98	34594S	N/A
594G	Ring Gear Kit w/ Mainshaft Hollow Type (Straight Teeth)	1	65-98	34594SK	34974A

TH400(M40) 3L80 TH375 - TH475 3L80HD

ILL.	DESCRIPTION	QTY.	YEAR	PART NO.	REFERENCE NO.
SUN GEARS, SHELLS & SUPPORTS					
612C	Sun Gear, Angled Teeth (28 Spline Inside).....	1	65-98	34612A	N/A
612C	Sun Gear, Angled Teeth (32 Spline Inside).....	1	65-98	34612	34971
612C	Sun Gear, Straight Teeth (32 Spline Inside).....	1	65-98	34612S	34971A
630C	Center Support (Direct Drum has Smooth Cam)	1	65-98	34630	N/A
630C	Center Support (Direct Drum has Lug Cam)	1	65-98	34630A	34846
SPRAGS					
652F	Sprag, Intermediate (8 Roller Type).....	1	72-98	34652	34419
652F	Sprag, Intermediate (16 Elements).....	1	65-77	34652B	34418
652F	Sprag, Intermediate (34 Elements) Heavy Duty	1	65-77	34652A	34418X
654G	Sprag, Low Clutch Roller (Rear)	1	65-98	34654	34402A
663F	Race, Intermediate Sprag (Outer Race .751").....	1	65-98	34663	34951
694	Retainer, Intermediate Sprag	1	65-98	34694	N/A
SHAFTS					
670A	Input Shaft	1	65-98	34670	N/A
672G	Mainshaft, 10 1/4" Long (w/ Restrictor Plug).....	1	65-98	34672	N/A
672G	Mainshaft, 10 3/16" Long (No Plug).....	1	65-98	34672A	N/A
674C	Shaft, Intermediate Sun Gear (32 Spline on Sun Gear)	1	65-96	34674	N/A
674C	Shaft, Intermediate Sun Gear (28 Spline on Sun Gear)	1	65-98	34674A	34970
678D	Output Shaft, 6" 4wd	1	82-98	34678HA	34655
678D	Output Shaft, 7" 4wd	1	77-82	34678H	34655A
678D	Output Shaft, 9" w/o Rubber O-Ring Groove	1	65-98	34678E	34655B
678D	Output Shaft, 9" Truck (Bolt-On Yoke) (Plastic Speed-O Gear).....	1	65-98	34678EA	N/A
678D	Output Shaft, 15" Car (375 Trans)	1	65-98	34678A	N/A
678D	Output Shaft, 15" (400 Trans)	1	65-98	34678B	N/A
GOVERNORS					
680D	Governor.....	1	65-98	34680	34410
684D	Gear, Governor Gear Repair Package	1	65-98	34684	K34411
681D	Gear Kit, Springs & Weights	1	65-98	44681-4K	K61931S
VALVE BODIES					
740D	Valve Body (Premium) (w/ no Rev Check Ball).....	1	87-Up	34740-4	P34990
740D	Valve Body (Premium) (w/ Rev Check Ball).....	1	87-Up	34740-5	P34990B
N.I.	Repair Kit, Fixes 5 Valve Body Plate Holes (Most w/ 1/4" Holes)	1	65-98	VB-101	96-350VB
CASES & HOUSINGS					
760D	Case, Chevy (6 Check Ball Type)	1	65-98	34760	N/A
760D	Case, Chevy (6 Check Ball Type) 4wd 6 Bolt Dust Cover	1	77-90	34760D	N/A
760D	Case, Chevy (7 Check Ball Type)	1	65-98	34760A	N/A
765H	Pan, Shallow (Chrome)	1	65-98	34765DC	TPC-400
765H	Pan, Deep	1	65-98	34765D	N/A
765H	Pan, Deep (Chrome).....	1	65-98	34765DD	TPC-400D
765H	Deep Pan Kit, w/ Filter Tube, Bolt & Spacer	1	65-98	34765DK	TPC-400DK
770H	Extension Housing, 4" Truck Bolt-On Large (34074) Rear Seal.....	1	65-98	34770C	N/A
774D	Speed-O Housing (34-39 T Gear Type) Aluminum.....	1	65-98	34774	34227
774D	Speed-O Housing (40-45 T Gear Type) Aluminum.....	1	65-98	34774A	34227A
789H	Spacer, Deep Pan Filter Bolt.....	1	65-98	34789	8629523
790H	Bolt, Filter Retainer 2-1/4" Long (Deep Pan)	1	76-98	34790	8633208
834	Pipe, Filter to Case (Shallow Pan)	1	65-98	34495A	34995
843D	Bracket, Holds Modulator to Case.....	1	65-98	34843	N/A
847D	Rotor, Speed-O Reluctor (Electronic Pick-Up)	1	65-98	34847R	N/A

TH400/3L80

TH400(M40) 3L80

TH375 - TH475 3L80HD

ILL.	DESCRIPTION	QTY.	YEAR	PART NO.	REFERENCE NO.
MISCELLANEOUS COMPONENTS					
906D	Spring, Front Servo	1	65-98	34906	N/A
907D	Piston, Front Servo (w/ 3 Tabs on Piston)	1	65-98	34907	N/A
910D	Servo Assembly, Rear	1	65-98	34910	N/A
910D	Servo Assembly, Rear (w/ Raised Hump on Piston)	1	65-98	34910A	K34956
913D	Pin, Rear Servo (3.303")	1	65-98	34913A	34708G
913D	Pin, Rear Servo (3.415")	1	65-98	34913E	N/A
913D	Pin, Rear Servo (3.443")	1	65-98	34913G	N/A
913D	Pin, Rear Servo (3.471")	1	65-98	34913H	34708
925D	Accumulator Assembly (Upgrade Service Package w/ Seals)	1	65-98	34925K	K34955
926D	Spring, Accumulator (White)	1	65-98	34926B	N/A
927D	Piston, Accumulator (Aluminum w/ 3 Legs)	1	65-98	34927	34707
933	Oversized Accum Pin Kit	1	65-98	34933X	34707P
933	Oversized Accum Pin & Reamer Kit	1	65-98	34933XK	T-9147
946D	Spring, Rear Servo (Blue)	1	65-98	34946	34706
946D	Spring, Rear Servo (Yellow)	1	65-98	34946A	N/A
965B	Piston, Direct (6 Clutch Late) Aluminum w/o Check Ball	1	65-98	34965E	34916
991H	Shaft, Manual Lever	1	65-98	34991-1	N/A
Tool	Governor Bore Repair Tool (Uses 30104A)	1	65-98	T-0107	T-0107
Tool	Governor Bore Repair Driver	1	65-98	T-0107-D	T-0107-D
Tool	Lip Seal Installer / Protector	1	65-98	T-0124	T-0124
N.I.	Transm. Changeover Kit, 700-R4 to 400 (4wd) (Blazer, P/U Suburban 4.3L & V8)	1	85-Up	7-40C	7-40C

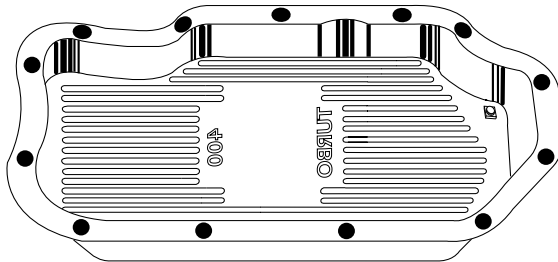

34765DC / TPC-400
Standard Chrome Pan

34765DD / TPC-400D
Deep Chrome Pan
Add extra fluid for better cooling!

34765DK / TPC-400DK
Contains:
Deep Chrome Pan
Pickup Tube (8629526) **D34495**
Bolt (8633208) **D34790**
Sleeve (8629523) **D34789**

NOTES

4L40E 4 SPEED, 5L40E 5 SPEED (M82), 5L50E (M22) - ELECTRONIC - RWD

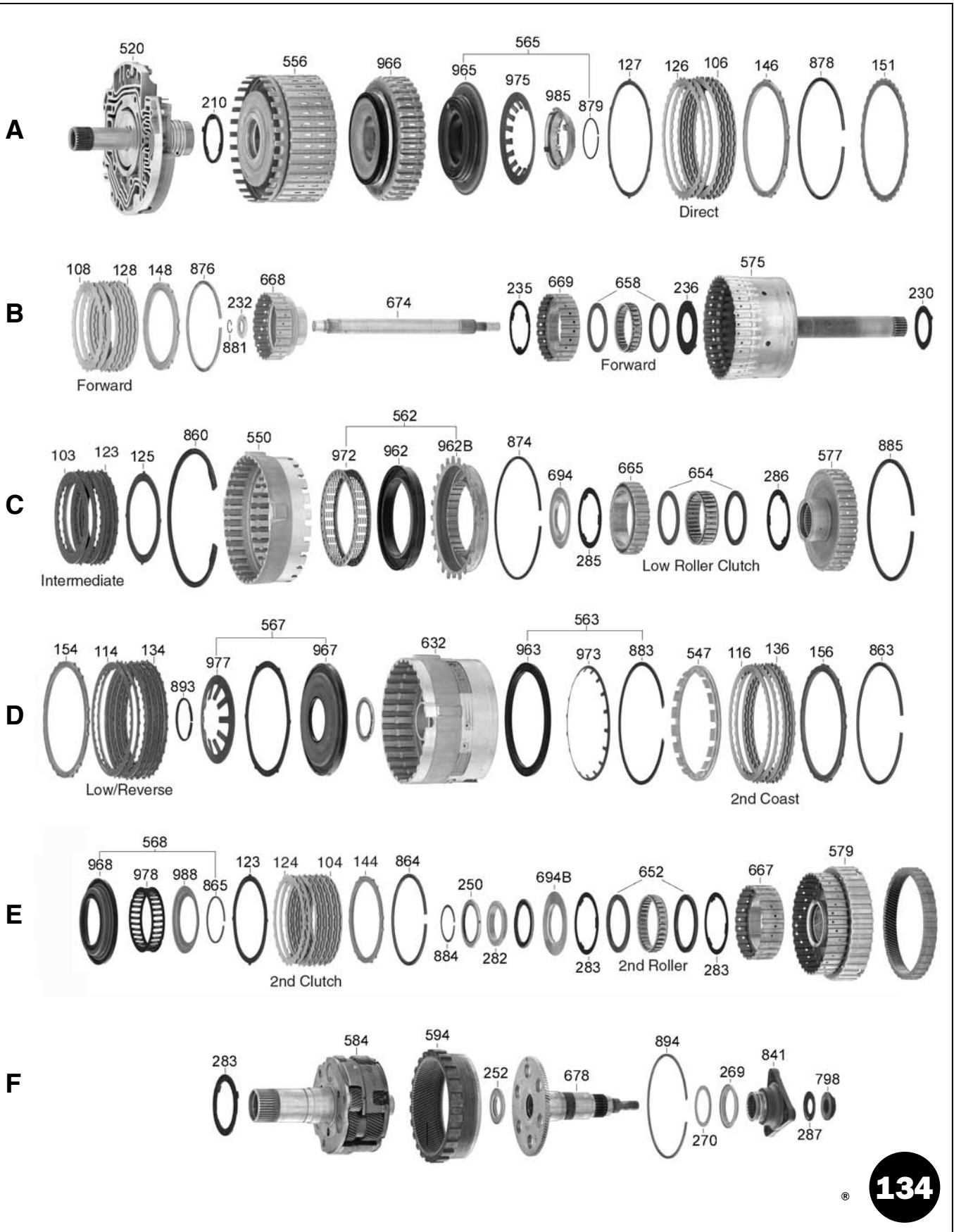

4L40E 4 SPEED, 5L40E 5 SPEED (M82), 5L50E (M22) - ELECTRONIC - RWD

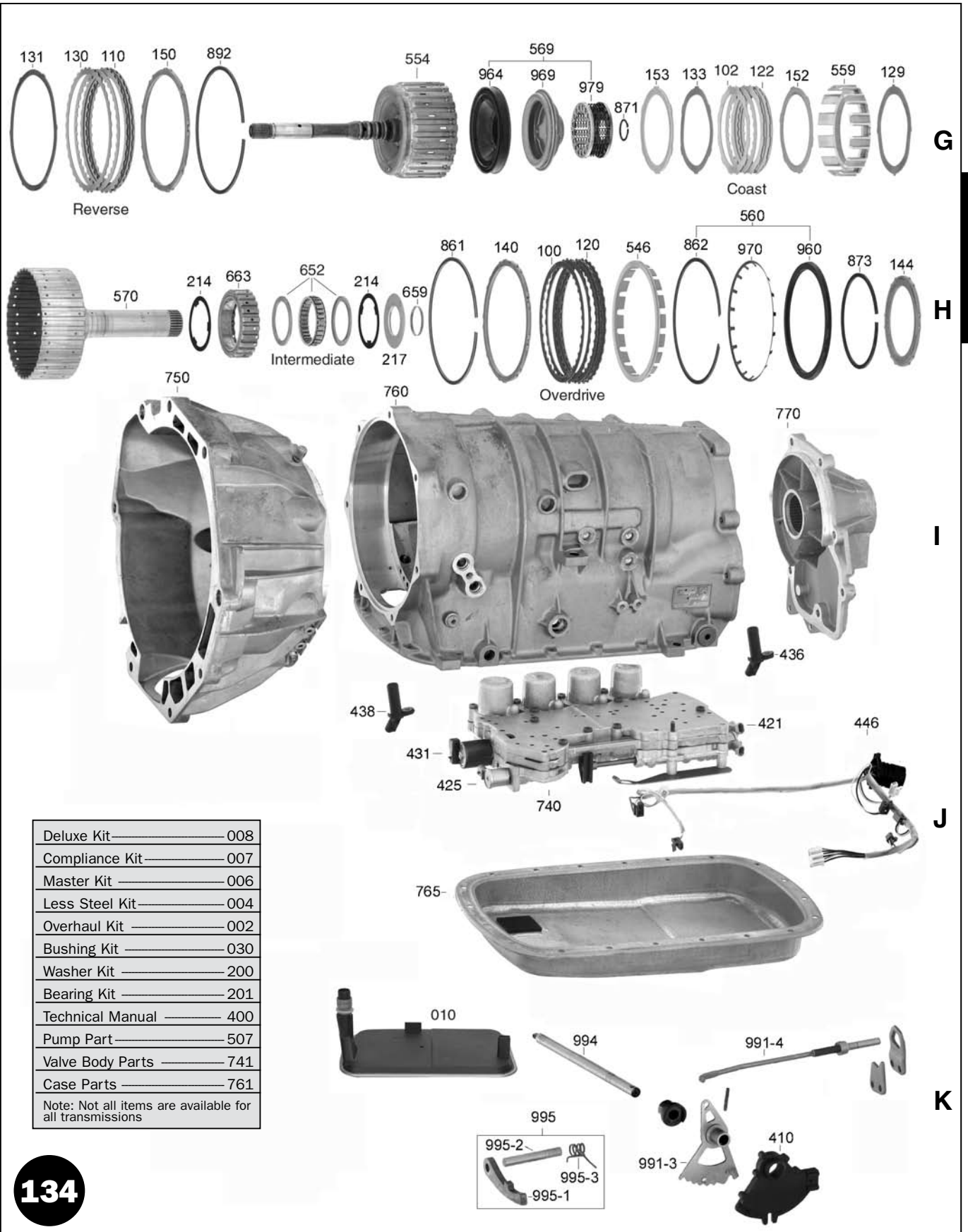

Deluxe Kit	008
Compliance Kit	007
Master Kit	006
Less Steel Kit	004
Overhaul Kit	002
Bushing Kit	030
Washer Kit	200
Bearing Kit	201
Technical Manual	400
Pump Part	507
Valve Body Parts	741
Case Parts	761

Note: Not all items are available for all transmissions

4L40E 4 SPEED, 5L40E 5 SPEED (M82), 5L50E (M22) - ELECTRONIC - RWD



134010E



134010EA



134010B

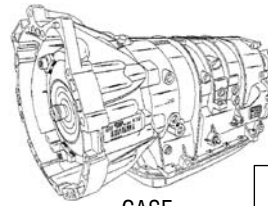

CASE



134300

BMW (4L/5L40E)	99-Up
Cadillac CTS (5L40E)	03-Up
XLR (5L50E)	04-Up

ILL.	DESCRIPTION	QTY.	YEAR	PART NO.	REFERENCE NO.
MASTER OVERHAUL KITS (WITH STEELS)					
006K	4L40E (w/ Pistons)	1	99-Up	134006B	K4100N
006K	5L40E, 5L50E (A5S, 360R) (w/ Pistons)	1	00-01	134006C	K4100M
006K	5L40E, 5L50E (A5S, 360R) (w/o Pistons, purchase A134960K separately)	1	00-01	134006	N/A
006K	5L40E, 5L50E (A5S, 360R) (w/ Pistons)	1	02-Up	134006D	K4100P
006K	5L40E, 5L50E (A5S, 360R) (w/o Pistons, purchase A134960AK separately)	1	02-Up	134006A	N/A
OVERHAUL KITS (W/ RINGS & SEALS)					
002K	4L40E, 5L40E, 5L50E (w/o Pistons).....	1	99-Up	134002	K41900M
FILTERS					
010J	Filter w/o Neck Spacer, Flat Inlet	1	99-Up	134010B	41800M
010J	Filter w/ Neck Spacer, 1/2" Tall Plastic Inlet	1	99-Up	134010	41800N
010J	Filter w/ Neck Spacer, Flat Inlet	1	99-Up	134010A	41800P
BUSHINGS					
030K	Bushing Kit	1	99-Up	134030	K41901M
034	Pump.....	1	99-Up	74034B	61005T
METAL CLAD SEALS					
070	Converter.....	1	99-Up	134070	41151F
074	Rear.....	1	99-Up	134074	41201F
FRICITION PLATES (ONE SIDED FRICTION) INTERNAL TEETH					
100H	Overdrive	2	99-Up	134100	41100M
102G	Coast.....	3	99-Up	134102	41108M
103C	Intermediate.....	3	99-Up	134103	41106M
104E	2nd Clutch (130mm OD)	5	99-01	134104	41102M
104E	2nd Clutch (138mm OD)	5	02-Up	134104A	41102AM
106A	Direct.....	4	99-Up	134106	41104M
108B	Forward	4	99-Up	134108	41110M
110G	Reverse	2	99-Up	134100	41100M
114D	Low Reverse.....	5	99-Up	134106	41104M
116D	2nd Coast (173mm OD)	3	99-01	134106	41104M
116D	2nd Coast (176mm OD).....	3	02-Up	134116	41104AM
STEEL PLATES (ONE SIDED FRICTION) EXTERNAL TEETH					
120H	Overdrive	2	99-Up	134120	41101M
122G	Coast.....	3	99-Up	134122	41109M
123C	Intermediate.....	3	99-Up	134123	41107M
124E	2nd Clutch (130mm OD)	5	99-01	134124	41103M
124E	2nd Clutch (138mm OD)	5	02-Up	134124A	41103AM
126A	Direct.....	4	99-Up	134126	41105M
128B	Forward	4	99-Up	134128	41111M
130G	Reverse	2	99-Up	134120	41101M
134D	Low/ Reverse.....	4	99-Up	134134	41112M
136D	2nd Coast (173mm OD)	4	99-01	134126	41105M
136D	2nd Coast (176mm OD).....	4	02-Up	134136	41105AM

4L40E 4 SPEED, 5L40E 5 SPEED (M82), 5L50E (M22) - ELECTRONIC - RWD

ILL.	DESCRIPTION	QTY.	YEAR	PART NO.	REFERENCE NO.
PRESSURE PLATES					
Prefix Key: D = OEM, A = Aftermarket New, R = Remanufactured					
140H	Overdrive	1	99-Up	134150	N/A
142	2nd Clutch (5.460" OD) (5L40E)	1	99-Up	134142	N/A
142	2nd Clutch (5.150" OD) (5L50E)	1	02-Up	134142A	N/A
144H	Intermediate.....	1	99-Up	134144	N/A
146A	Direct.....	1	99-Up	134146	N/A
148B	Forward (Top)	1	99-Up	134148	N/A
150	Reverse Clutch Backing (18 T)	1	99-Up	134150	N/A
151	Reverse Clutch Apply (36 T).....	1	99-Up	134151	N/A
152	Coast Clutch Backing	1	99-Up	134152	N/A
153	Coast Clutch Apply.....	1	99-Up	134153	N/A
154D	Low/ Reverse Clutch	1	99-Up	134154	N/A
156	2nd Coast (6 T) (5L40E)	1	99-Up	134156	N/A
156	2nd Coast (18 T) (5L50E)	1	02-Up	134156A	N/A
SEALING RINGS					
175K	Sealing Ring Kit.....	1	99-Up	134175	N/A
GASKETS & O-RINGS					
300	Gasket, Pan (Bonded)	1	99-Up	134300	13600MR
310	Gasket, Pump	1	99-Up	134310	13601M
311	O-Ring, Pump	1	99-Up	134311	13602M
320	Gasket, Valve Body (Upper).....	1	99-Up	134320	N/A
321	Gasket, Valve Body (Lower)	1	99-Up	134321	N/A
322	Gasket, Valve Body Channel Plate.....	1	99-Up	134322	N/A
TECHNICAL MANUALS					
400K	Tech Manual	1	99-Up	134400	41Y05
400K	Transmission Guide (GM).....	1	99-Up	134400A	N/A
ELECTRICAL COMPONENTS					
421J	Solenoid, Shift (1-2, 2-3, 4-5).....	3	99-Up	134421	5A-555
425J	Solenoid, TCC.....	1	99-Up	74418E	5A-187
431J	Solenoid, EPC (Holley)	1	99-03	84431G	5A-186
431J	Solenoid, EPC (Bosch)	1	04-Up	84431H	5D-186B
446J	Wire Harness, Internal.....	1	99-Up	134446	35A-555
HARD PARTS					
Prefix Key: D = OEM, A = Aftermarket New, R = Remanufactured					
PUMPS					
520A	Pump Stator (11 Bolt, Cast 095304).....	1	99-Up	134520	41424M
520A	Pump Stator (Code 1268-190100)	1	02-Up	134520A	N/A
531	Pump Rotor Kit	1	99-Up	134531K	K41201M
532	Pump Rotor (13 Vane, .707" Thick)	1	99-Up	74532C	61802A
533	Pump Vane Kit (Qty 13).....	1	99-Up	74533K-1B	K61801A
534	Pump Slide (.707").....	1	99-Up	74534CA	61803A
535	Pump Slide Pivot Pin.....	1	99-Up	54535B	32805
536	Pump Spring, Outer Slide (.645" OD)	1	99-Up	134536	N/A
538	Pump Vane Ring, Hardened Steel	2	99-Up	54538BS	32322SP
539	Pump Rotor Guide (13 Vane Type).....	1	99-Up	74539C	61422A
540	Spring, Pump Slide Pivot Pin	1	99-Up	54540B	D32806
507K	Valve w/ Sleeve, Boost	1	99-Up	134507FK	K41971M
507K	Valve w/ Sleeve, Press Reg (requires T-55211-TL8).....	1	99-Up	134507PK	N/A

4L40E, 5L40E

4L40E 4 SPEED, 5L40E 5 SPEED (M82), 5L50E (M22) - ELECTRONIC - RWD

ILL.	DESCRIPTION	QTY.	YEAR	PART NO.	REFERENCE NO.
DRUMS & CLUTCH HUBS					
550C	Intermediate / Overdrive Clutch Housing (3 Clutch) (5L40E).....	1	99-Up	134550	41964M
550C	Intermediate / Overdrive Clutch Housing (2 Clutch) (5L50E).....	1	02-Up	134550A	N/A
554G	Forward / Coast Clutch Drum w/ Shaft (9 1/8" Long Shaft) (5L40E).....	1	99-Up	134554	41963M
554G	Forward / Coast Clutch Drum w/ Shaft (8 15/16" Long Shaft) (5L50E).....	1	02-Up	134554A	N/A
556A	Direct / Reverse Clutch Drum, Stamped Steel (31T Reluctor) (5L40E).....	1	99-Up	134556	41962M
559G	Coast Clutch Housing (1.380" Thick) (5L40E).....	1	99-Up	134559	N/A
559G	Coast Clutch Housing (1.265" Thick) (5L50E).....	1	02-Up	134559A	N/A
570H	Overdrive / Reverse Clutch Hub (36 T).....	1	99-Up	134570	41974M
575B	Forward Clutch Hub With Shaft & Sprag Assembly.....	1	99-Up	134575K	41970M
575B	Direct Clutch Hub w/ Shaft (5L40E).....	1	99-Up	134575	41972M
575B	Direct Clutch Hub w/ Shaft (5L50E).....	1	02-Up	134575A	N/A
577C	Low / Reverse Clutch Hub w/ Low Sprag Inner Race.....	1	99-Up	134577	N/A
579E	2nd Coast Clutch Hub (5L40E).....	1	99-Up	134579	N/A
579E	2nd Coast Clutch Hub (5L50E).....	1	02-Up	134579A	N/A
PLANETS					
583	Planetary Package Including Ring Gear (4L40E).....	1	99-Up	134583	K41950M
583	Planetary Package Including Ring Gear (5L40E).....	1	02-Up	134583A	K41950BM
584F	Planetary (1 Groove) (5L40E).....	1	99-Up	134584	N/A
584F	Planetary (No Groove) (5L50E).....	1	02-Up	134584A	N/A
594F	Ring Gear (106 T Left Angle) (1 OD Groove) (5L40E).....	1	99-Up	134594	N/A
594F	Ring Gear (107 T Left Angle) (No OD Groove) (5L40E).....	1	99-Up	134594A	N/A
594F	Ring Gear (110 T Left Angle) (1 OD Groove) (5L50E).....	1	02-Up	134594B	N/A
594F	Ring Gear (114 T Left Angle) (No OD Groove) (5L50E).....	1	02-Up	134594C	N/A
CENTER SUPPORTS					
632D	Center Support (6 T 2nd Coast Steels) (5L40E).....	1	99-Up	134632	41965M
632D	Center Support (36 T 2nd Coast Steels) (4L40E).....	1	02-Up	134632A	41965BM
SPRAGS					
642	Low Sprag Assembly.....	1	99-Up	134642	41976M
646	2nd Sprag Assembly.....	1	99-Up	134646	41978M
652H	Sprag, Intermediate Clutch (2.929" OD).....	1	99-Up	134658	41960M
652E	Sprag, 2nd Clutch (3.415" OD).....	1	99-Up	134652	41960R
654C	Sprag, Low Roller Clutch (3.205" OD).....	1	99-Up	134654	41960P
658B	Sprag, Forward Clutch (2.929" OD).....	1	99-Up	134658	41960M
SHAFTS					
674B	Input Sun Gear Shaft (11 1/2" Long) (5L40E).....	1	99-Up	134674	N/A
674B	Input Sun Gear Shaft (11 11/16" Long) (5L50E).....	1	02-Up	134674A	N/A
678F	Output Shaft (106 T Ring Gear Type) (5L40E).....	1	99-Up	134678	N/A
678F	Output Shaft (114 T Ring Gear Type) (5L50E).....	1	02-Up	134678A	N/A
VALVE BODIES					
740J	Valve Body (Premium) 789 Code.....	1	99-01	134740-1	P41990L
740J	Valve Body (Premium) 378 Code.....	1	02-Up	134740-2	P41990M
740J	Valve Body (Premium) 374 Code.....	1	04-Up	134740-3	P41990P
741K	Kit, AFL Valve & Sleeve (requires T-F-55211-TL & T-VB-Fix).....	1	99-Up	134741LK	K41888M
741K	Kit, TCC Reg. Valve & Sleeve (requires T-F-55211-TL4).....	1	99-Up	134741QK	K41884M
741K	Repair Kit, Pump & VB Actuator Feed, Press. Reg. Repair (Refill # 134741RK).....	1	99-01	134741K	K41866
PISTON KITS					
960	Piston Kit (Bonded).....	1	99-01	134960K	N/A
960	Piston Kit (Bonded).....	1	02-Up	134960AK	K41528M

DRIVEN

TO BE THE BEST IN...



QUALITY PARTS

TRANSTAR
TRANSTAR INDUSTRIES, INC.®

TRANSTAR INDUSTRIES, INC. • 7350 YOUNG DRIVE • CLEVELAND, OHIO 44146 • WWW.TRANSTAR1.COM

AT TRANSTAR, WE'RE DRIVEN TO BRING YOU THE PRODUCTS AND SERVICES YOU NEED TO HELP YOUR BUSINESS THRIVE. BEYOND BRINGING YOU QUALITY BRANDS, COMPETITIVE PRICING, WORLDWIDE DISTRIBUTION AND SAME-DAY SERVICE TO MOST U.S. MARKETS, WE BRING YOU THE INDUSTRY-LEADING ONLINE INVENTORY AND ORDERING TOOLS DESIGNED TO GIVE YOU THE EDGE.
DRIVEN TO BE THE BEST FOR YOU.

800.359.3339 | www.transtar1.com



TH700-R4(MD8), 4L60 4L60E(M30), 4L65E(M32), 4L70E(M70)

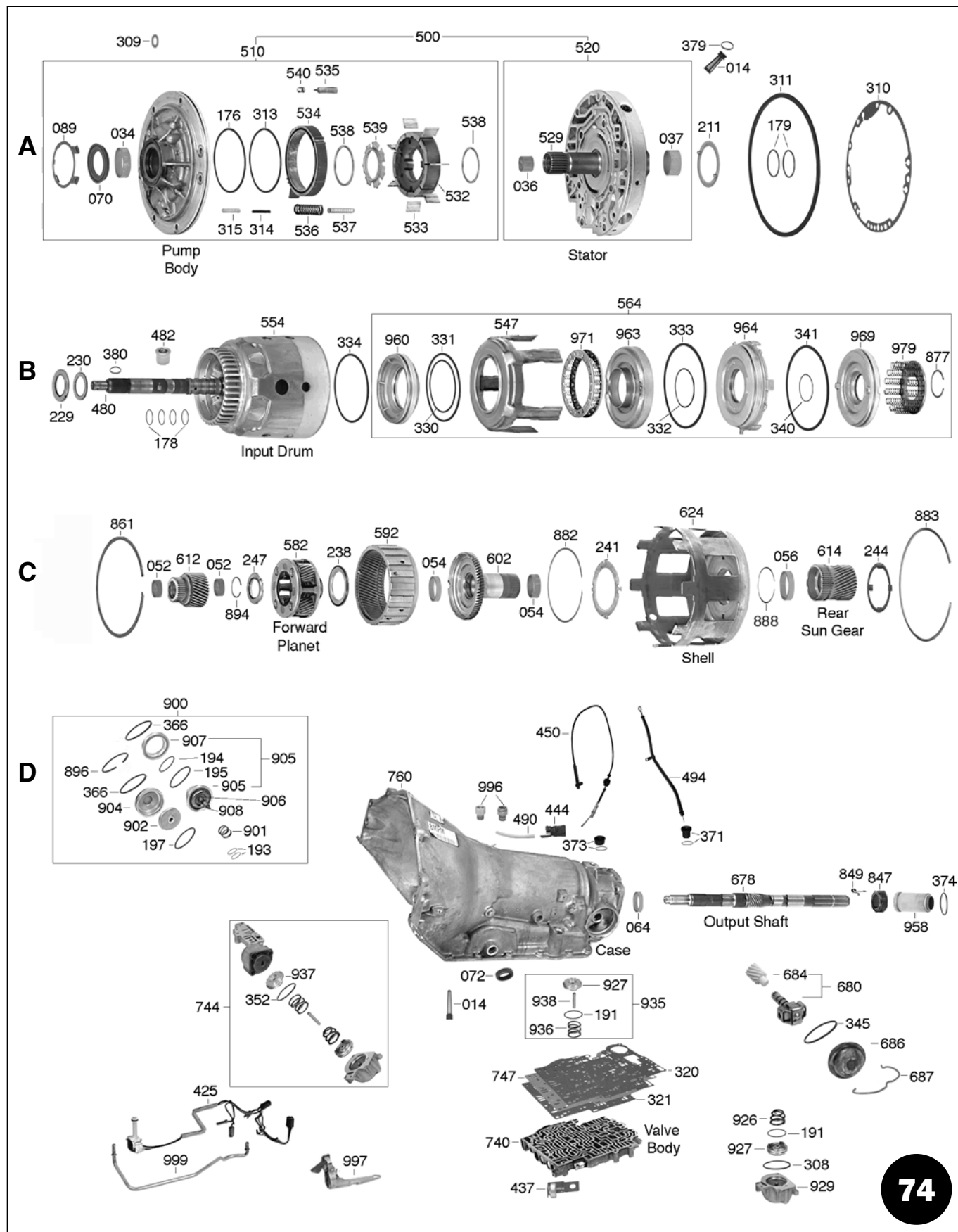

TH700-R4(MD8), 4L60 4L60E(M30), 4L65E(M32), 4L70E(M70)

700-R4, 4L60E

E

020 480 046 556 046 966 566 976 893 335 131 130 110 150 892 334

Rev./Input Drum Rev. Clutch

F

136 116 149 129 475 881 658 232 648 574 669 668 128 108 148 876 235 981 141 141 100 120 140

Overrun Clutch Forward Sprag Forward Clutch 3rd & 4th Clutch

G

664 884 654 630 884 584 251 114 134 155 135 594 604 889 238 886 977 567 967 339 338 339

Low/Rev. Sprag Center Support Rear Planet Low/Rev. Clutch

H

348 770 066 074 379 010 839 011 300 765 774 848 078 369 842

Ext. Hsg. Filter Pan

351304 301304A 331304A Use 331304A

Deluxe Kit	008
Compliance Kit	007
Master Kit	006
Less Steel Kit	004
Overhaul Kit	002
Bushing Kit	030
Washer Kit	200
Bearing Kit	201
Technical Manual	400
Pump Part	507
Valve Body Parts	741
Case Parts	761

Note: Not all items are available for all transmissions

74

TH700-R4(MD8), 4L60 4L60E(M30), 4L65E(M32), 4L70E(M70)



74010



74010E

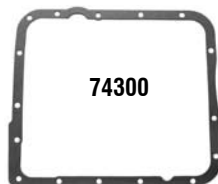

74300

TH700-R4 82-93
4L60E 93-Up
4L65E 01-Up
Various GM Cars & Trucks

Please refer to the Vehicle & Model Transmission Guide for more information.

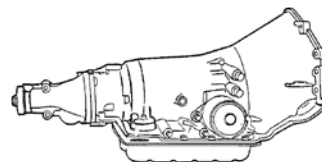

Rear Wheel Drive

ILL.	DESCRIPTION	QTY.	YEAR	PART NO.	REFERENCE NO.
DELUXE KITS (SUPER KITS) (1)					
008H	700-R4.....	1	82-84	74008	K6100-R
008H	700-R4.....	1	85-E87	74008A	K6100A-R
008H	700-R4.....	1	L87-93	74008B	K6100B-R
008H	4L60E (w/ 3-4 Bonded Piston).....	1	1/5/93-96	74008E	K6100E-R
008H	4L60E (w/ Pistons) Shallow Pan.....	1	97-03	74008EB	N/A
008H	4L60E (w/ Pistons) Deep Pan.....	1	97-03	74008EC	N/A
008H	4L60E (w/ Pistons).....	1	04-Up	74008ED	N/A
008H	4L65E (w/ Pistons).....	1	02-Up	74008G	N/A
COMPLIANCE KITS (CALIFORNIA KITS) (1)					
007H	700-R4.....	1	82-84	74007	CK6100-R
007H	700-R4.....	1	85-E87	74007A	CK6100A-R
007H	700-R4.....	1	L87-93	74007B	CK6100B-R
007H	4L60E (w/ 3-4 Bonded Piston).....	1	1/5/93-96	74007E	CK6100E-R
007H	4L60E (w/ Pistons) Shallow Pan.....	1	97-03	74007EB	N/A
007H	4L60E (w/ Pistons) Deep Pan.....	1	97-03	74007EC	CK6100F-R
007H	4L60E (w/ Pistons).....	1	04-Up	74007ED	N/A
007H	4L65E (w/ Pistons).....	1	02-Up	74007G	N/A
MASTER OVERHAUL KITS (WITH STEELS) (1)					
006H	700-R4.....	1	82-84	74006	K6100
006H	700-R4.....	1	85-E87	74006A	K6100A
006H	700-R4.....	1	L87-93	74006B	K6100B
006H	4L60E (w/ 3-4 Bonded Piston).....	1	93-1/4/93	74006E	N/A
006H	4L60E (w/ 3-4 Bonded Piston).....	1	1/5/93-96	74006EA	K6100E
006H	4L60E (w/ Pistons).....	1	97-03	74006EB	K6100F
006H	4L60E (w/ Pistons).....	1	04-Up	74006ED	K6100G
006H	4L65E (w/ Pistons).....	1	02-Up	74006G	K6100FT / GT
LESS STEEL KITS (1)					
004H	700-R4.....	1	82-84	74004	K6100-LS
004H	700-R4.....	1	85-E87	74004A	K6100A-LS
004H	700-R4.....	1	L87-93	74004B	K6100B-LS
004H	4L60E (w/ 3-4 Bonded Piston).....	1	93-96	74004E	K6100E-LS
004H	4L60E (w/ Pistons).....	1	97-03	74004EB	K6100F-LS
004H	4L60E (w/ Pistons).....	1	04-Up	74004ED	K6100G-LS
004H	4L65E (w/ Pistons).....	1	02-Up	74004G	K6100FT/GT-LS
OVERHAUL KITS (W/ RINGS & SEALS) (1)					
002H	700-R4.....	1	82-93	74002C	K61900C
002H	4L60E, 4L65E.....	1	92-03	74002E	K61900E
002H	4L60E, 4L65E.....	1	04-Up	74002G	F61900G
GASKET & SEAL KITS (W/O RINGS & SEALS) (1)					
000H	700-R4.....	1	82-93	74000C	K61900C-1
000H	4L60E, 4L65E.....	1	92-03	74000E	K61900E-1
	<i>(1) - To order Kits with Fiber pan gaskets, use an "F" suffix.</i>				

TH700-R4(MD8), 4L60 4L60E(M30), 4L65E(M32), 4L70E(M70)

ILL.	DESCRIPTION	QTY.	YEAR	PART NO.	REFERENCE NO.
FILTER KITS					
011H	700-R4 (All - Latest Design).....	1	82-93	74011	FK61710
011H	4L60E Shallow Pan (Exc 97-Up Corvette).....	1	93-Up	74011E	FK61710E
011H	4L60E Shallow Pan (97-Up Corvette).....	1	97-Up	74011EA	FK61710F
011H	4L60E Deep Pan (Exc Colorado, Canyon & H3).....	1	97-Up	74011EC	FK61710G
011H	4L60E Deep Pan (Colorado & Canyon 4wd 04-Up, H3 06-Up).....	1	04-Up	74011ED	FFK61710JP
FILTERS					
010H	700-R4 (All - Latest Design).....	1	82-93	74010	61710
010H	4L60E Shallow Pan 93-97 (Exc 1997 Corvette) (Filtran).....	1	93-97	74010E	61710E
010H	4L60E Shallow Pan 93-Up (Exc 97-Up Corvette) (Filtertek).....	1	93-Up	E74010EB	61710EP
010H	4L60E Shallow Pan (97-Up Corvette).....	1	97-Up	74010EA	61710F
010H	4L60E Shallow Pan (97-Up Corvette) (Filtertek).....	1	97-Up	E74010EA	61710FP
010H	4L60E Deep Pan 97-03 (Filtran) (Exc Colorado, Canyon & H3).....	1	97-03	74010EC	61710G
010H	4L60E Deep Pan 97-Up (Filtertek) (Exc Colorado, Canyon & H3).....	1	97-Up	E74010EC	61710GP
010H	4L60E Deep Pan (Colorado & Canyon 4wd 04-Up, H3 06-Up).....	1	04-Up	74010ED	61710J
014A	Screen, Governor.....	1	82-93	74014A	61711
014A	Screen, Pump.....	1	82-93	74014	61712
016	Screen, Shift Solenoid (Snaps on Valve Body Plate) (Small).....	1	93-Up	74016A	61713A
016	Screen, Pressure Control Solenoid (Snaps on Valve Body Plate) (Large).....	1	93-Up	74016P	61713
016	Screen, TCC Solenoid (in Case).....	1	82-Up	74014A	61711
016	Screen, TCC Solenoid (in Solenoid Snout).....	1	98-Up	74016B	61711A
BANDS					
Prefix Key: B = Borg Warner, A = OEM (Exc BW), N = All Other New, R = Relined					
020E	Intermediate (2 Tang).....	1	82-Up	74020A	61700
020E	Intermediate (2 Tang) (Pro Series).....	1	82-Up	74020AK	61700X
020E	Intermediate (2 Tang) (Hi-Energy Lining).....	1	82-Up	74020AH	61700H
020E	Intermediate (2 Tang) (2.625" Wide Power Band) (Red).....	1	82-Up	74020C	61700W
020E	Intermediate (2 Tang) (2.625" Wide Power Band) (Carbon).....	1	82-Up	74020CK	N/A
BUSHINGS					
030H	Bushing Kit (w/ Babbitt 74034).....	1	82-Up	74030	K61901A
030H	Bushing Kit (w/ Teflon Coated 74034B).....	1	82-Up	74030E	K61901T
034A	Pump Body (Babbitt).....	1	82-Up	74034	61005
034A	Pump Body (Teflon Coated).....	1	82-Up	74034B	61005T
036A	Stator (Front) .900" ID.....	1	82-E84	54036A	32006
036A	Stator (Front) 1.000" ID.....	1	L84-Up	44036B	35007A
037A	Stator (Rear) .435" Wide.....	1	82-91	74037	61003
037A	Stator (Rear) .468" Wide.....	1	92-Up	74037A	61003A
046E	Reverse Drum (Front).....	1	82-Up	74046	61006
046E	Reverse Drum (Rear).....	1	82-Up	54046A	32001
052C	Input Sun Gear.....	2	82-Up	74052	61008
054C	Reaction Shaft (Front).....	1	82-Up	74054	61009
054C	Reaction Shaft (Rear).....	1	82-Up	74054A	61010
056C	Rear Sun Gear.....	1	82-Up	74056	61011
056C	Rear Sun Gear (Wide).....	1	82-Up	74056	61011W
064D	Case (Babbitt).....	1	82-Up	44064	35012
064D	Case (Bronze).....	1	82-Up	74064	35012A
064D	Case (Oversized) (Bag of 5).....	1	82-Up	74064B	35012X
066H	Ext Housing (Babbitt).....	1	82-Up	44066	8008A
066H	Ext Housing (Bronze, Dimpled).....	1	82-Up	44066B	8008
066H	Ext Housing (Teflon Coated).....	1	82-Up	74066T	8008T
METAL CLAD SEALS					
070A	Front.....	1	82-Up	74070	61151C
072D	Linkage Shaft.....	1	82-Up	44072	38511

700-R4, 4L60E

TH700-R4(MD8), 4L60 4L60E(M30), 4L65E(M32), 4L70E(M70)

ILL.	DESCRIPTION	QTY.	YEAR	PART NO.	REFERENCE NO.
METAL CLAD SEALS (Cont.)					
074H	Rear (Exc Corvette)	1	82-Up	44074	8850B
074H	Rear (Exc Corvette) (Triple Lip Vamac)	1	82-Up	74074	8850C
074H	Rear (Corvette)	1	97-Up	74074D	61152
075	Drive Shaft Yoke Seal (Teckpak)	1	82-Up	T44075	T-9145R
078H	Speed-O Shaft	1	82-Up	44078X	3991LS
089A	Retainer (Front Seal Lock)	1	82-Up	74089	61991
FRICTION PLATES					
100F	3/4 Clutch (.080")	6	82-Up	74100	61108
100F	3/4 Clutch (.080") (Hi-Energy)	6	82-Up	74100A	61108H
100F	3/4 Clutch (.067") (Hi-Energy) (4L65E)	6	02-Up	74100D	61108HX
100F	3/4 Clutch (.080") (Hi-Performance) (Red)	AR	82-Up	A74100HP	61108R
100F	3/4 Clutch (.062") (Hi-Performance) (Blue)	AR	82-Up	R74100CHP	61108AX
100F	3/4 Clutch (.062") (Hi-Performance) (Red)	AR	82-Up	A74100CHP	61108RX
100F	3/4 Clutch (.062") (Commercial) Tan	AR	82-Up	74100C	61108X
100F	3/4 Clutch (.062") (Commercial) (Hi-Energy)	AR	82-Up	74100CA	61108HX
108F	Forward (.080")	5	82-84	74108	61104
108F	Forward (.070")	5	85-Up	74108C	61104A
108F	Forward (.070") (Hi-Performance) (Blue)	5	85-93	R74108AHP	61104AX
108F	Forward (.070") (Hi-Performance) (Red)	5	85-93	A74108AHP	61104AR
110E	Reverse Input (.078")	4	82-E87	74110	61100
110E	Reverse Input (.078") (Hi-Performance) (Red)	4	82-E87	A74110HP	61100R
110E	Reverse Input (.070")	4	L87-Up	74110A	61100A
110E	Reverse Input (.070") (Hi-Performance) (Brown)	4	L87-Up	74110AHP	61100AX
110E	Reverse Input (.070") (Hi-Performance) (Red)	4	L87-Up	A74110AHP	61100AR
114G	Low & Reverse	5	82-Up	74114	35109
114G	Low & Reverse (Hi-Performance) (Brown)	5	82-Up	R74114HP	35109X
114G	Low & Reverse (Hi-Performance) (Red)	5	82-Up	A74114HP	35109R
116F	Overrun	2	82-Up	74116	61102
116F	Overrun (Hi-Performance) (Blue)	2	82-Up	R74116HP	61102X
116F	Overrun (Hi-Performance) (Red)	2	82-Up	A74116HP	61102R
STEEL PLATES					
120F	3/4 Clutch (.077") (15 T)	5	82-E87	74120	61109
120F	3/4 Clutch (.077") (20 T w/ Notch) (Retro Fits 82-93)	5	L87-E93	74120A	61109C
120F	3/4 Clutch (.060") (20 T w/ Notch) (Kolene)	AR	82-E93	74120E	61109XK
120F	3/4 Clutch (.060") (20 T w/ Notch) (Commercial)	AR	82-E93	74120B	61109X
120F	3/4 Clutch (.095")	6	02-Up	74120D	61109G
120F	3/4 Clutch (.106")	5	L93-Up	74120C	61109E
120F	3/4 Clutch (.106") (Kolene)	5	L93-Up	74120CK	61109EK
128F	Forward (.078")	4	82-84	74128	61105
128F	Forward (.090")	4-5	85-Up	74128A	61105D
128F	Forward (.090") (Kolene)	4-5	85-Up	74128AK	61105DK
129F	Forward (.052") (Waved)	1	82-Up	74129B	61105B
129F	Forward (.070") (Waved)	1	82-Up	74129	61105A
130E	Reverse Input (.078")	3	82-96	74130	61101
130E	Reverse Input (.078") (Turbulator Plate w/ 4 Holes)	4	97-Up	74130B	61101H
130E	Reverse Input (.090")	AR	82-Up	74130A	61101X
131E	Reverse Input (.080") (Waved)	1	82-E87	74131A	61101A
131E	Reverse Input (.051") (Dished)	1	L87-Up	74131C	61101F
131E	Reverse Input (.071") (Dished)	1	L87-Up	74131D	N/A
131E	Reverse Input (.088") (Dished)	1	L87-Up	74131B	61101C
131E	Reverse Input Drum Saver (Waved)	1	L87-Up	74131G	61101S
134G	Low & Reverse (.068")	5	82-96	44134	35101
134G	Low & Reverse (.068") (Kolene)	5	82-96	44134K	35101K
135G	Low & Reverse (.095") (Waved)	1	82-96	74135	61101E
134G	Low & Reverse (.080") (Oversized)	AR	93-96	44134X	35101X
134G	Low & Reverse (.049") (Turbulator Plate w/ 4 Holes)	AR	97-Up	74134B	N/A

TH700-R4(MD8), 4L60 4L60E(M30), 4L65E(M32), 4L70E(M70)

ILL.	DESCRIPTION	QTY.	YEAR	PART NO.	REFERENCE NO.
STEEL PLATES (Cont.)					
134G	Low & Reverse (.067") (Turbulator Plate w/ 4 Holes)	5	97-Up	74134BA	35101H
134G	Low & Reverse (.089") (Turbulator Plate w/ 4 Holes)	AR	97-Up	74134BB	N/A
136F	Overrun	2	82-Up	74136	61103
FRICITION & STEEL KITS					
N.I.	Friction Kit, 3/4 Clutch (Powerpack) (Hi-Perf)	1	82-Up	A74100CAPK	N/A
N.I.	Friction & Steel Kit, 3/4 Clutch (.062") (Tan) (w/ P. Plate, 9 Frictions & 10 Steels)	1	82-Up	A74100CPK	K61-61A
N.I.	Friction & Steel Kit, 3/4 Clutch Z Pak (7 Friction, 7 Steel Kit & 2 Press. Plates).....	1	82-Up	74100EK	N/A
N.I.	Friction & Steel Kit, 3/4 Clutch (.062") (Hi-Perf) (Red) (w/ P. Plate & Kolene Steels).....	1	82-Up	A74100CPPK	N/A
N.I.	Steel Module (700-R4).....	1	82-84	74139	N/A
N.I.	Steel Module (700-R4).....	1	85-E87	74139A	N/A
N.I.	Steel Module (700-R4).....	1	L87-93	74139B	N/A
N.I.	Steel Module (4L60E).....	1	93-1/4/93	74139B	N/A
N.I.	Steel Module (4L60E).....	1	1/5/93-Up	74139EA	N/A
N.I.	Steel Module (4L65E).....	1	02-Up	74139G	N/A
PRESSURE PLATES					
Prefix Key: D = OEM, A = Aftermarket New, R = Remanufactured					
141F	Backing Plate, 3/4 Clutch (5.00-5.25mm) #3	1	82-86	74140C	61109C
140F	Backing Plate, 3/4 Clutch (.160")	1	87-Up	74140JC	61109M
140F	Backing Plate, 3/4 Clutch (.193")	1	87-Up	74140JB	61109L
140F	Backing Plate, 3/4 Clutch (.230")	1	87-Up	74140JA	61109K
141F	Apply Plate, 3/4 Clutch (.130") (Flat)	1	82-86	74141A	61107
141F	Apply Plate, 3/4 Clutch (.213") (Flat w/ Tangs).....	1	93-Up	74141C	61107D
141F	Apply Plate, 3/4 Clutch (.220") (Flat w/ Tangs).....	1	93-Up	74141B	61107C
148F	Forward Clutch 6.75mm.....	1	82-86	74148	61105C
148F	Forward Clutch 7.70mm.....	1	87-Up	74148A	61715
148F	Forward Clutch 8.25mm.....	1	87-Up	74148B	61715A
148F	Forward Clutch 8.90mm.....	1	87-Up	74148C	61715B
148F	Forward Clutch 9.47mm.....	1	87-Up	74148D	61715C
149F	Apply Plate, Forward Clutch 6.44mm.....	1	82-86	74149	61106
149F	Apply Plate, Forward Clutch 6.44mm.....	1	87-Up	74149B	61106B
150E	Reverse Input Clutch 5.79-5.95mm	1	L87-Up	74150A	61714
150E	Reverse Input Clutch 6.52-6.68mm	1	L87-Up	74150B	61714B
150E	Reverse Input Clutch 7.25-7.41mm	1	L87-Up	74150D	61714C
155G	Spacer Plate, Low/ Reverse Clutch 1.24mm (.049")	1	90-Up	74155A	61716B
155G	Spacer Plate, Low/ Reverse Clutch 2.25mm (.089")	1	90-Up	74155B	61716C
155G	Spacer Plate, Low/ Reverse Clutch 2.41mm (.095")	1	L87-Up	74155C	61716
155G	Spacer Plate, Low/ Reverse Clutch 3.18mm (.125")	1	84-Up	74155	N/A
VALVE BODY RECALIBRATION KITS					
165H	Shift Kit®, 700-R4 (Transgo®).....	1	82-93	T74165	K61908
165H	Shift Kit-Jr®, 700-R4 (Junior) (Transgo®).....	1	86-93	T74167	K61908J
165H	Shift Kit®, 4L60E (Transgo®).....	1	93-Up	T74165E	K61908E
165H	Shift Correction Package, 700-R4 (Superior)	1	82-93	S74165	61C01
165H	Shift Correction Package, 4L60E (Exc 98-Up w/ EC3) (Superior)	1	93-97	S74165E	61C02
165H	Valve Body Kit, 4L60E (Exc 98-Up w/ EC3) (RatioTek)	1	93-Up	A74165EA	N/A
165H	Sure Cure Kit, 700-R4 (requires T-77917-TL) (Sonnax).....	1	82-93	S74174	61S01
165H	Shift Correction Package, 4L60E (98-Up w/ EC3) (Superior).....	1	98-Up	S74165EA	61C03
165H	Sure Cure Kit, 4L60E (requires T-77917-TL, T-77754-TL, T-77754-R2) (Sonnax).....	1	93-Up	74174A	61S03
165H	Reprogramming Kit™, 700-R4 Hi-Perf & HD Automatic or Manual Shift (Transgo®) ..	1	82-93	T74171	700-2-3
165H	Reprogramming Kit™, 4L60E Hi-Perf HD & Sport Truck (Transgo®)	1	93-Up	T74171E	4L60E-HD2
165H	Reprogramming Kit™, 4L60E Racing, Manual Shift Only, Important Note:	1	93-Up	T74173E	4L60E-3
165H	(Transplants w/ No Computer, Must Use T74173E & T74431A) (Transgo®).....				
165H	Valve Body Kit, Hi-Performance 700-R4 (Superior).....	1	82-93	S74171	61C-HP

700-R4, 4L60E

TH700-R4(MD8), 4L60 4L60E(M30), 4L65E(M32), 4L70E(M70)

ILL.	DESCRIPTION	QTY.	YEAR	PART NO.	REFERENCE NO.
VALVE BODY RECALIBRATION KITS (Cont.)					
971	Clutch Spring Kit, Heavy Duty & Hi-Perf (Transgo®)	1	82-Up	74971K	K61908S
165H	Converter Valve Kit, 700-R4 Non-Lock-up Pump Conversion (Transgo®).....	1	82-93	T74165A	K61908V
165H	Converter Valve Kit, 4L60E Non-Lock-up Pump Conversion (Transgo®)	1	93-Up	T74165C	K61908P
165H	Pump Ring Kit, Hardened Steel Rings & (Standard) Springs (Transgo®)	1	82-Up	T74165B	K32804
165H	Pump Ring Kit, NoYoYo®, Hi-Perf *Engines Over 5500 RPM (Transgo®)	1	82-Up	T74165HP	K32804H
165H	Vacuum / Boost Valve Bypass Kit, 4L60E (Transgo®).....	1	93-Up	T34161E	N/A
431	Vacuum Pressure Control Kits, 4L60E (Transgo®).....	1	93-Up	T74431A	46-MOD
741H	Valve Kit, Actuator Feed Limit, 4L60E (requires T-77754-TL) (Sonnax)	1	93-Up	74741LK	K61968
SEALING RINGS					
175H	Ring Kit Combo.....	1	82-Up	74175T	K61903T
175H	Ring Kit (4L60E)	1	93-Up	74175BT	K61903
178B	Ring Kit, Servo Only (Viton D-Rings)	1	82-Up	74175DVK	K61900-3
178B	Ring Kit, Turbine Shaft (Stepped Cut) (w/ 4 74178BT)	1	82-Up	74178BTK	N/A
178B	Turbine Shaft (Solid) (White)	4	82-Up	74178AT	61301T
178B	Turbine Shaft (Stepped Cut).....	4	82-Up	74178BT	61301X
178B	Turbine Shaft (Scarf cut)	4	82-Up	74178T	61301X
179A	Stator (Scarf Cut).....	2	82-Up	54179AT	32300T
179A	Stator (Solid) (Teflon).....	2	93-Up	74179BT	61300T
191D	Accumulator (Replaced By # 54352A Rubber).....	2	82-93	54352A	13965
193D	Intermediate Band Apply Pin.....	2	82-93	54193BT	32323
194D	2nd Apply Piston (Inner) 2.162"	1	82-Up	74194AT	61303T
194D	2nd Apply Piston (Inner) 2.639"	1	82-Up	74194DT	61306T
195D	2nd Apply Piston (Outer)	1	82-Up	74195T	61304T
197D	4th Apply Piston (Outer)	1	82-Up	74197T	61302T
THRUST WASHERS					
200H	Washer Kit	1	82-Up	74200	K61907
200H	Washer Kit (w/o Selectives).....	1	82-Up	74200A	N/A
211A	Stator To Drum.....	1	82-Up	74211	61401
230B	Input Drum 1.87-1.97mm (# 67).....	1	82-Up	74230	61400
230B	Input Drum 2.04-2.14mm (# 68).....	1	82-Up	74230A	61400A
230B	Input Drum 2.21-2.31mm (# 69).....	1	82-Up	74230B	61400B
230B	Input Drum 2.38-2.48mm (# 70).....	1	82-Up	74230C	61400C
230B	Input Drum 2.55-2.65mm (# 71).....	1	82-Up	74230D	61400D
230B	Input Drum 2.72-2.82mm (# 72).....	1	82-Up	74230E	61400E
230B	Input Drum 2.89-2.99mm (# 73).....	1	82-Up	74230F	61400F
230B	Input Drum 3.06-3.16mm (# 74).....	1	82-Up	74230G	61400G
235F	Input Carrier to Race (Plastic).....	1	82-85	74235	61402A
241C	Reaction Shaft to Shell (Brass).....	1	82-Up	74241	61403
241C	Reaction Shell (The Beast)	1	82-Up	74241A	61406B
244C	Shell Rear (Plastic).....	1	82-Up	44244A	35406A
229B	Shim, Stator to Input Housing (10 Per Kit)	1	82-Up	74229S	K61400S
255	Shim, Rear Case (.010")	1	82-Up	44255	N/A
N.I.	Repair Kit, Planet All .025" Thick (8 Round & 8 Batwing Washers)	1	82-Up	74204A	K61442A
N.I.	Repair Kit, Planet All .025" Thick (16 Round Washers).....	1	82-Up	74204C	K61442
BEARINGS					
201H	Bearing Kit (kit may not include the 74238A or 74241B)	1	82-Up	74201A	K61907B
229B	Stator to Input Drum.....	1	82-Up	74229	61466
232F	Input Drum to Sun Gear.....	1	82-Up	74232	61652
238C	Front Planet to Reaction Shaft (700-R4, 4L60E)	1	82-Up	74238	61491
238C	Front Planet to Reaction Shaft (5 Gear) (4L65E)	1	01-Up	74238A	N/A
238G	Rear Hub to Case	1	82-Up	74238	61491
241C	Reaction Shaft to Shell (4L65E).....	1	01-Up	74241B	61494
247C	Front Planet to Front Sun Gear	1	82-Up	74247A	61492A
250	Rear Planet to Sun Gear (Plan Pinions Must Be Removed)	1	82-Up	74250	61493
251G	Rear Planet to Support	1	82-Up	74251	61415

TH700-R4(MD8), 4L60 4L60E(M30), 4L65E(M32), 4L70E(M70)

ILL.	DESCRIPTION	QTY.	YEAR	PART NO.	REFERENCE NO.
GASKETS & O-RINGS					
300H	Gasket, Pan (Cork)	1	82-Up	74300	13960X
300H	Gasket, Pan (Fiber).....	1	82-Up	74300F	13960F
308D	Gasket, Accumulator Cover to Plate.....	1	82-Up	74308	N/A
309A	Gasket, Pump Bolt Washer	7	82-E86	44309	13268A
309A	O-Ring, Pump Bolt Washer.....	7	L86-Up	74312A	13268B
310A	Gasket, Pump	1	82-E83	74310	13360
310A	Gasket, Pump	1	L83-Up	74310A	13360A
311A	O-Ring, Front Pump	1	82-03	74311	13794
311A	O-Ring, Front Pump (molded seal)	1	04-Up	74311A	13794B
313A	O-Ring, Pump Slide to Body.....	1	82-Up	54313B	13982
314A	Seal, Pump Slide (Rubber)	1	82-Up	54314B	13768
315A	Seal, Pump Slide (Teflon)	1	82-Up	54315B	13762
320D	Gasket, Upper Valve Body, 700-R4	1	82-86	74320A	13361B
320D	Gasket, Upper Valve Body, 700-R4.....	1	87-93	74320B	13361C
320D	Gasket, Upper Valve Body, 4L60E.....	1	93-00	74320EA	13361E
320D	Gasket, Upper Valve Body, 4L60E, 4L65E (White Stripe)	1	01-Up	74320EB	13361F
321D	Gasket, Lower Valve Body, 700-R4.....	1	82-86	74321A	13362B
321D	Gasket, Lower Valve Body, 700-R4.....	1	87-93	74321B	13362C
321D	Gasket, Lower Valve Body, 4L60E	1	93-00	74321EA	13362E
321D	Gasket, Lower Valve Body, 4L60E, 4L65E (White Stripe).....	1	01-Up	74321EB	13362F
328	O-Ring, TCC Solenoid	1	82-Up	44380	13917
330B	Lip Seal, 3/4 Clutch (Inner).....	1	82-Up	74330	N/A
332B	Lip Seal, Forward Clutch (Inner)	1	82-Up	74332	N/A
333B	Lip Seal, Forward Clutch (Outer).....	1	82-Up	74333	N/A
334E	O-Ring, Input Drum To Forward Piston Housing.....	1	82-Up	74334	N/A
334E	Lip Seal, Reverse Input (Inner).....	1	82-Up	74334A	N/A
335E	Lip Seal, Reverse Input (Outer)	1	82-86	74335	N/A
335E	Lip Seal, Reverse Input (Outer)	1	87-Up	74335A	N/A
338G	Lathe Cut Seal, Low/ Reverse Clutch (Inner)	1	82-Up	44338	3773L
339G	Lathe Cut Seal, Low/ Reverse Clutch (Outer).....	1	82-Up	44339	N/A
339G	Lathe Cut Seal, Low/ Reverse Clutch (Center).....	1	82-Up	44339C	13536
340B	Lip Seal, Overrun Clutch (Inner).....	1	82-Up	74340	N/A
341B	Lip Seal, Overrun Clutch (Outer).....	1	82-Up	74341	N/A
348H	O-Ring, Case to Ext Housing	1	82-Up	44348	3896L
348H	Lathe Cut Seal, Case to Ext Housing	1	82-Up	74348E	13364
352D	Seal, 1-2 & 3-4 Accumulator (Rubber, Replaces 54191AT).....	2	82-Up	54352A	13965
366D	O-Ring, Servo Cover (Inner Red)	1	82-Up	74366	13363
366D	O-Ring, Servo Cover (Outer Blue).....	1	82-Up	74366A	13597
368	O-Ring, Case Connector, 700-R4	1	82-93	44369B	3410L
347	O-Ring, Case Connector, 4L60E, 4L65E	1	93-Up	74347	3410LE
352D	Lathe Cut Seal, Forward Clutch Accumulator Piston.....	1	93-Up	74352	13965F
366D	O-Ring Kit For S74902H.....	1	82-Up	74366AK	N/A
369H	O-Ring, Speed-O Housing (Outer, 1 7/8" OD).....	1	82-Up	44369A	3126L
369H	O-Ring, Speed Sensor.....	1	96-Up	34370	N/A
371D	Boot, Filler Tube	1	82-Up	44371B	13925
374D	O-Ring, Output Shaft Sleeve to Slip Yoke (Light Trucks)	1	82-Up	44374B	N/A
373D	Boot, Detent Cable	1	82-Up	54373B	13581
379H	Seal, Filter 700-R4	1	82-93	74379	13745
379H	Seal, Filter 4L60E, 4L65E	1	93-Up	74379E	13745E
379	O-Ring, Pump Cover Screen O-Ring	1	82-Up	74379P	3566P
380B	O-Ring, Input Shaft (Small, V-8 Type)	1	82-Up	44380	13917
380B	O-Ring, Input Shaft (Small, 4 & 6 Cyl. Type)	1	82-Up	64380	13766
N.I.	External Seal Kit	1	82-Up	74390	SK61900-2
TECHNICAL MANUALS					
400H	Tech Manual, 700-R4.....	1	82-86	74400	61Y01
400H	Tech Manual, 700-R4	1	87-91	74400A	61Y04
400H	Tech Manual, 700-R4 Explains Changes During 1987-88.....	1	87-88	74400H	61Y02
400H	Tech Manual, 4L60E.....	1	93-Up	74400E	61Y03

700-R4, 4L60E

TH700-R4(MD8), 4L60 4L60E(M30), 4L65E(M32), 4L70E(M70)

ILL.	DESCRIPTION	QTY.	YEAR	PART NO.	REFERENCE NO.
TECHNICAL MANUALS (Cont.)					
400H	Tech Manual, 4L60E, Update	1	93-Up	74400EA	61Y05
400H	Transmission Guide (GM) 700-R4	1	82-93	74400EC	N/A
400H	Transmission Guide (GM) 4L60E, 4L65E	1	82-93	74400ED	N/A
400H	Rebuild Procedures	1	82-Up	74400EB	N/A
ELECTRICAL COMPONENTS (700-R4)					
410D	Switch, 4-3 Pulse (On Valve Body, 2 Prong) (Normally Closed)	1	82-93	74411A	15A-119
410D	Switch, High Gear Pressure 1 Prong	1	82-93	54411B	15D-112
410D	Switch, TCC Signal (1 Prong) (Normally Open)	1	82-93	74411B	15A-118
410D	Switch, 3rd - 4th Clutch (2 Button) (Normally Open)	1	82-93	64412	15A-111
410D	Switch, 4th Gear Lock-Up Delay Kits (Superior)	1	82-93	74416AK	15A-133S
425D	Solenoid, TCC Universal	1	82-93	54425B	5U-147
425D	Solenoid, TCC Type 1 (White) (PT, 1G2, w/ 3, w/ 4, w/ P, w/ T)	1	82-93	74425D	5D-131
425D	Solenoid, TCC Type 2 (Black) (PT, 1G1, w/ P)	1	82-93	74425C	5D-133
425D	Solenoid, TCC Type 2 (Yellow) (PT, 1G1, w/ 4, w/ P)	1	82-93	74425A	5D-132
425D	Solenoid, TCC Type 4 (Red) (PT, EG, w/ 4, w/ P)	1	82-93	74425B	5D-134
425D	Solenoid, TCC Type 5 (Blue) (PT, EG)	1	82-93	74425G	5D-135
425D	Solenoid, TCC Type 6 (Dark Green) (PT, EG)	1	82-93	74425F	5D-136
425D	Solenoid, TCC Type 7 (Grey) (PT, 1G2, w/ 4, w/ T)	1	82-93	74425H	N/A
425D	Solenoid, TCC Type 9 (Orange) (PT, EG, w/ 4)	1	82-93	74425E	5A-139
425D	Solenoid, TCC Type 10 (Brown) (PT, 1G2, w/ 4, w/ P)	1	82-93	74425HA	5A-140
425D	Solenoid, TCC Type 15 (Dark Blue) (PT, EG, w/ 4, w/ P, w/ O)	1	82-93	74425J	5D-141
425D	Solenoid, TCC Type 18 (Light Brown)	1	82-93	74425L	5D-145
425D	Solenoid, TCC Type 19 (Light Green)	1	82-93	74425M	5D-146
425D	Solenoid, TCC Type 23 (Black)	1	82-93	74425T	5D-163
437D	Switch, Vehicle Speed (VSS)	1	82-93	74436	20A-215
437D	Switch, Temperature	1	82-93	74437	15D-121
444D	Connector, Case (2 Prong)	1	82-93	74444	N/A
444D	Connector, Case (3 Prong)	1	82-93	74444A	25A-103
444D	Connector, Case (4 Prong)	1	82-93	84444	25A-104
444D	Connector, Case (Universal 2, 3, 4 Prong)	1	82-93	84444U	N/A
445	External Wire Harness Repair Kit, 3 Prong Square	1	82-93	74445A	35D-106A
445	External Wire Harness Repair Kit, 4 Prong Square	1	82-93	74445	35D-106
445	External Wire Harness Repair Kit, 5 Prong Round	1	82-93	74445B	35D-109D
N.I.	Lock-up Delay Module For Vehicle w/ Speed Sensor	1	82-93	LU1	30A-100
ELECTRICAL COMPONENTS (4L60E, 4L65E)					
410D	Switch, MLP Sensor (PRNDL) (4L60E) (One 7 Pin & One 4 Pin Connector)	1	95-03	74410A	15D-327
410D	Switch, MLP Sensor (PRNDL) (4L65E) (One 11 Pin Connector)	1	04-Up	74410B	15D-327A
418	Solenoid (3-2 Down Shift) (PWM) Round (Front) (Gray Connector)	1	93-95	74418E	5A-187
418	Solenoid (3-2 Down Shift) (On-Off) (White Connector)	1	96-Up	74418EA	5A-192
420	Solenoid, Master Kit (Combo) (74442 MPS Not Included)	1	93-02	74420K	N/A
420	Solenoid, Master Kit	1	93-94	A74420K	31R-173
420	Solenoid, Master Kit	1	1995	A74420AAK	31R-173A
420	Solenoid, Master Kit	1	96-02	A74420AK	31R-173B
421	Solenoid, 1-2 & 2-3 Shift	2	93-Up	74421	5R-174
425D	Solenoid, TCC Universal	1	93-Up	54425B	5U-147
425D	Solenoid, TCC (Round) (Front)	1	93-Up	74418E	5A-187
425D	Solenoid, TCC & Wire Harness (Also Replaces All 93-96 OE Harnesses)	1	93-02	74425NC	5T-173
425D	Solenoid, TCC & Wire Harness (Non PWM TCC & PWM 3-2) 6 Solenoid	1	93-95	74425N	5D-173
425D	Solenoid, TCC & Wire Harness (Blue Connector) (PWM TCC & 3-2)	1	94-96	74425Q	5D-173A
425D	Solenoid, TCC & Wire Harness (Gray Connector) (3-2 On-Off) 6 Solenoid	1	96-02	74425S	5D-173B
425D	Solenoid, TCC & Wire Harness (Square EPC Connector)	1	03-06	74425ND	5R-173E
425D	Solenoid, TCC & Wire Harness (Input Sensor Design - Pump)	1	06-Up	74425NE	5D-173G
431	Vacuum Pressure Control Kit	1	93-Up	74431A	46-MOD
435	Solenoid, EPC (1.5" Black Can, 2 Prong Connector on the Bottom)	1	93-02	34435A	5D-152A

TH700-R4(MD8), 4L60 4L60E(M30), 4L65E(M32), 4L70E(M70)

ILL.	DESCRIPTION	QTY.	YEAR	PART NO.	REFERENCE NO.
ELECTRICAL COMPONENTS (4L60E, 4L65E) (Cont.)					
435	Solenoid, EPC (1.5" Silver Can, 2 Prong Connector on the Side)	1	03-Up	34435B	5D-152B
435	Repair Kit, EPC Solenoid w/ Tool Kit (Transgo) 4 Repairs in One Kit.....	1	93-Up	T34435RK	5A-152K
435	Refill Kit for T34435RK.....	1	93-Up	T34435ARK	4L6-SOL-4
436	Sensor, Vehicle Speed (VSS) (Also 96 Corvette)	1	93-E96	74436	20A-215
436	Sensor, Vehicle Speed (VSS) (Exc 96 Corvette)	1	L96-Up	74436A	20D-216
438	Sensor, Input (Pump)	1	06-Up	74438G	20D-173G
442D	Switch, Manifold Pressure.....	1	94-Up	74442	15D-171
444D	Bracket, Connector Wire Harness	1	93-Up	74444-1	61890
445	Repair Kit, External Wire Harness (13 Wire) (Plugs into Connector).....	1	93-98	74445GK	35R-105
446	Repair Kit, Internal Wire Harness (13 Prong) (w/ Case Connector)	1	93-98	74446GK	N/A
446	Repair Kit, PRNDL Harness (95-03 use w/74410A, 04-Up use w/74410B)	1	95-Up	74446K	35A-114K
446	Repair Kit, Speed Sensor Connector	1	95-Up	74446CK	35R-216
448	Repair Kit, ECM Harness Repair Kit (3 Wires)	1	93-Up	74448K	35R-130
448	Repair Kit, ECM Harness Repair Kit (1 Wire)	1	93-Up	74448AK	35A-130
CAPSULES & PLUGS					
475F	Seal, Input Housing to Output Shaft (w/ Splines) (Plastic) 700-R4.....	1	82-93	74475	13598
480	Capsule w/ Check Ball, 3-4 Accumulator (Fits In Case, Near Servo Bore)	1	87-Up	74480D	61978
482	Capsule w/ Check Ball, Input Drum Replacement (Spring Loaded) (repl. D74482A)....	1	87-Up	A74482A	N/A
482	Capsule w/ Check Ball, Input Drum (.310" OD) (Fits Under Piston).....	1	87-Up	D74482A	N/A
480	Capsule w/ Check Ball, Input Drum (Fits In Turbine Shaft)	1	82-Up	74480	61926A
482	Capsule w/ Check Ball, Low/ Reverse Piston, 700-R4.....	1	82-93	74481	61980
480	Capsule w/ Check Ball, Reverse Input Drum (Fits In Drum)	1	82-Up	54480A	32764
480	Capsule w/ Check Ball, Servo Release (Fits In Valve Body).....	1	82-Up	74480C	61981
482	Capsule w/ Check Ball, Stator (.260" OD) (Fits In Stator)	1	82-Up	74482P	N/A
482	Capsule w/ Check Ball, Under Low/ Reverse Piston	1	82-Up	74482C	61979
480	Capsule w/ Check Ball, Various GM Drum/Stator .260" Diameter (Copper)	1	82-Up	54480C	N/A
482	Orifice Plug, Input Drum (Under # 230 Spacer).....	2	82-Up	74482B	N/A
507	Orifice Plug, Stator 4.3mm	1	82-Up	74507-2	N/A
483	Cup Plug, Park Pawl Shaft.....	1	82-Up	54483A	13970
483	Cup Plug (.170" OD)	1	82-Up	74483D	N/A
496	Retaining Clip (For 3/8" Push-In Type Cooler Fittings).....	2	96-97	74496A	N/A
507	Capsule, TCC Pump Orifice (Pkg of 5)	1	82-Up	74507C-6	61980P
HARD PARTS					
Prefix Key: D = OEM, A = Aftermarket New, R = Remanufactured					
PUMPS					
500A	Pump (700-R4) (.900" Input Shaft) (Stator Cast # 031 or 025) (Body Cast # 380).....	1	82-E84	74500	61200A
500A	Pump (700-R4) (1.00" Input Shaft) (Non Auxiliary Type).....	1	84-3/87	74500A	61200B
500A	Pump (700-R4) (Auxiliary Valve Body Type)	1	4/87-93	74500B	61200D
500A	Pump (4L60E) (1 Piece Case) Non PWM.....	1	93-94	74500C	61200E
500A	Pump (4L60E) (1 Piece Case) PWM.....	1	95-Up	74500D	61200F
500A	Pump (4L60E) (2 Piece Case) (298mm Converter) (uses 74311 Pump O-Ring)	1	96-Up	74500DA	61200H
500A	Pump (4L60E) (2 Piece Case) (300mm Converter) (uses 74311 Pump O-Ring)	1	97-03	74500G	61200J
500A	Pump (4L60E) (2 Piece Case) (300mm Converter) (uses 74311A Molded Seal).....	1	04-Up	74500H	61200K
500A	Pump (4L60E) (2 Piece Case) (310mm Converter) (uses 74311A Molded Seal).....	1	04-Up	74500HA	61200L
500A	Pump (4L65E)	1	04-Up	74500J	61200N
520A	Stator (Cast# 101, 596, or 612) (Non PWM)	1	93-95	74520C	N/A
520A	Stator (Cast# 504, 838 or 955)	1	95-Up	74520D	N/A
520A	Stator (Cast# 611 or 705)	1	97-Up	74520G	N/A
529A	Stator Shaft Tube (298mm Converter) (82-97 700-R4, 4L60E).....	1	82-97	74529B	61969
529A	Stator Shaft Tube (300mm Converter) (98-05 4L60E)	1	98-05	74529C	61969B
529A	Stator Shaft Tube (245mm & 298mm) (06-Up 4L70E).....	1	06-Up	74529D	N/A
529A	Stator Shaft Tube (300mm Converter) (06-Up 4L70E)	1	06-Up	74529E	N/A

700-R4, 4L60E

TH700-R4(MD8), 4L60 4L60E(M30), 4L65E(M32), 4L70E(M70)

ILL.	DESCRIPTION	QTY.	YEAR	PART NO.	REFERENCE NO.
PUMP COMPONENTS					
531	Rotor Kit, 10 Vane (w/ Slide) (.7074").....	1	86-96	74531AK	K32800A
531	Rotor Kit, 10 Vane (w/o Slide) (.7074").....	1	86-96	74531AA	K32802A
531	Rotor Kit, 10 Vane (w/o Slide) (.7079").....	1	86-96	74531AB	K32802C
531	Rotor Kit, 13 Vane (w/ Slide) (.7074").....	1	97-Up	74531CK	K61800A
531	Rotor Kit, 13 Vane (w/o Slide) (.7069").....	1	97-Up	74531C	N/A
531	Rotor Kit, 13 Vane (w/o Slide) (.7074").....	1	97-Up	74531CA	K61802A
532A	Rotor, 7 Vane (.7074").....	1	82-86	54532B	32802
532A	Rotor, 10 Vane (.7074").....	1	86-96	54532BA	32802A
532A	Rotor, 13 Vane (.7074").....	1	97-Up	74532C	61802A
533A	Vanes	7-13	82-Up	64533	32800
533A	Vane Kit (Package of 7).....	1	82-86	74533K-1	K32801
533A	Vane Kit (Package of 10).....	1	86-96	74533K-1A	K32801A
533A	Vane Kit (Package of 13).....	1	97-Up	74533K-1B	K61801A
533A	Vane & Ring Kit (10 Vane, Heavy Duty).....	1	82-93	74533K	N/A
534A	Pump Slide (.7069").....	1	82-96	54534A	32803
534A	Pump Slide (.7074").....	1	82-96	54534B	N/A
534A	Pump Slide (.7074").....	1	97-Up	74534CA	61803A
534A	Pump Slide (.7079").....	1	97-Up	74534CB	N/A
534A	Pump Slide (.7084").....	1	97-Up	74534CC	N/A
534A	Pump Slide (.7089").....	1	97-Up	74534CD	N/A
535A	Pivot Pin, Pump Slide.....	1	82-Up	54535B	32805
536A	Spring, Pump Slide (Outer).....	1	93-Up	74536	N/A
537A	Spring, Pump Slide (Inner).....	1	93-Up	74537	N/A
N.I.	Spring Kit, Pump Slide (Inner & Outer Springs).....	1	82-Up	74536K	K61210
N.I.	Spring Kit, Pump Slide (Inner & Outer Springs, 2 Vane Rings).....	1	93-Up	74538BK	N/A
N.I.	Spring Kit (w/ 2 Pump Rotor Rings and Springs).....	1	82-Up	T74165B	K32804
538A	Vane Ring, Silver (OE type Sintered Iron).....	2	82-Up	54538B	32322
538A	Vane Ring, Black (Special Alloy).....	2	82-96	54538BS	32322SP
538A	Vane Ring, Silver (Special Alloy).....	2	97-Up	74538C	61322SP
539A	Rotor Guide, 7 Vane.....	1	82-86	54539B	32422
539A	Rotor Guide, 10 Vane.....	1	86-96	54539BA	32422A
539A	Rotor Guide, 13 Vane.....	1	97-Up	74539C	61422A
540A	Spring, Pump Slide (Under Pivot Pin).....	1	82-Up	54540B	32806
176A	Ring, Slide to Body (Metal).....	1	82-Up	54176B	32320
314A	Seal, Pump Slide (Rubber).....	1	82-Up	54314B	13768
315A	Seal, Pump Slide (Teflon).....	1	82-Up	54315B	13762
547B	Apply Ring, 3-4 Clutch # 7 (5 Fingers).....	1	82-Up	74547	N/A
507H	Orifice Plug, Stator (Inside Tube).....	1	82-Up	74507-2	N/A
507H	Spring, Pressure Regulator, 700-R4.....	1	82-93	74507PA-3	N/A
507H	Spring, Pressure Regulator, 700-R4 (Green).....	1	82-93	54507BP-3A	N/A
507H	Spring, Pressure Regulator (Outer), 4L60E.....	1	93-Up	74507MB	61965E
507H	Spring, Pressure Regulator, 700-R4 (1.94" Long).....	1	82-93	74507MA	61965A
507H	Spring, Pressure Regulator, 700-R4 (2.10" Long).....	1	82-93	54507P-3	61965
507H	Valve Kit, Boost, 700-R4 (.423" Dia. Valve) (w/ O-Ring).....	1	82-93	74507TBK	K61976B
507H	Valve Kit, Boost, 700-R4 (.471" Dia. Valve).....	1	82-93	74507JA	K61976C
507H	Valve Kit, Boost, 700-R4 (.471" Dia. Valve) (w/ O-Ring).....	1	82-93	74507TAK	K61976G
507H	Valve Kit, Boost, 700-R4 (.500" Dia. Valve).....	1	82-93	74507J	K61976D
507H	Valve Kit, Boost, 700-R4 (.500" Dia. Valve) (w/ O-Ring).....	1	82-93	74507TK	K61976E
507H	Valve Kit, Boost, Steel, 4L60E.....	1	93-97	74507EK	K61908B
507H	Valve Kit, Boost, Aluminum, 4L60E (.470") (w/ O-Ring).....	1	93-05	74507FA	K61908SC
507H	Valve Kit, Boost, Aluminum, 4L60E (.470").....	1	93-05	74507FC	K61908SE
507H	Valve Kit, Boost, Aluminum, 4L60E (.471", 1.90" Long) (OEM).....	1	93-05	74507FD	DK61908A
507H	Valve Kit, Boost, Aluminum, 4L60E (.471", 1.80" Long) (OEM).....	1	06-Up	74507FE	DK61908G
507H	Valve Kit, Boost, Aluminum, 4L60E (.490") (w/ O-Ring).....	1	93-05	74507F	K61908SB
507H	Valve Kit, Boost, Aluminum, 4L60E (.490").....	1	93-05	74507FB	K61908SD
507H	Valve Kit, Boost, Aluminum, 4L60E (.506", 1.90" Long) (OEM).....	1	93-05	74507TEK	DK61908C
507H	Valve Kit, Boost, Aluminum, 4L60E (.506", 1.80" Long) (OEM).....	1	06-Up	74507TDC	DK61908H

TH700-R4(MD8), 4L60 4L60E(M30), 4L65E(M32), 4L70E(M70)

ILL.	DESCRIPTION	QTY.	YEAR	PART NO.	REFERENCE NO.
PUMP COMPONENTS (Cont.)					
507H	Valve Kit, Reverse Boost, 700-R4 (.283"OD) (w/ O-Ring)	1	82-93	74507RDK	K61977D
507H	Valve Kit, Reverse Boost, 700-R4 (.283"OD)	1	82-93	74507RBK	K61977
507H	Valve Kit, Reverse Boost, 700-R4 (.296"OD)	1	82-93	74507RGK	K61977A
507H	Valve Kit, Reverse Boost, 700-R4 (.300" OD)	1	82-93	74507RAK	N/A
507H	Valve Kit, Reverse Boost, 4L60E (.490" OD) (uses ORMK-10 O-Rings)	1	93-Up	74507F	K61908SB
507H	Valve, Pressure Regulator, 700-R4 (w/ 2 Flats)	1	82-93	74507B	61964
507H	Valve, Pressure Regulator, 700-R4 (Oversized) (requires T-77917-TL).....	1	82-93	74507P-1	61964V
507H	Valve, Pressure Regulator, 4L60E	1	93-Up	D74507PE-1	61964E
507H	Valve, Pressure Regulator, 4L60E (Oversized) (requires T-77917-TL)	1	93-Up	74507PE-1	61964EV
507H	Valve, T.V. Boost (.471" Diameter Valve)	1	82-93	74507TA-1	N/A
507H	Valve, TCC Apply, 700-R4 (uses S74186 Rings).....	1	82-93	74507C-1	61908V
507H	Valve, TCC Apply, 4L60E (Non PWM) (uses S74186 Rings).....	1	93-Up	74507C-1	61908V
507H	Valve, TCC Apply, 4L60E (PWM) (uses S74186 Rings).....	1	93-Up	74507CE-1	61908P
507H	Valve, TCC Replacement, PWM Power-Valve.....	1	93-Up	A74507CEK	K61908L
DRUMS					
554B	Input Drum & Shaft w/ Pilot (Exc 2.8L or 4 Cyl) (298mm, 27 Spline Converter)	1	82-E84	74554	61971
554B	Input Drum & Shaft w/ Pilot (Exc 2.8L or 4 Cyl) (298mm, 30 Spline Converter)	1	L84-86	74554B	61971D
554B	Input Drum & Shaft w/ Pilot (Exc 2.8L or 4 Cyl) (298mm, 30 Spline Converter)	1	87-Up	74554DA	61971E
554B	Input Drum & Shaft no Pilot (2.8L & 4 Cyl) (245mm, 27 Spline Converter)	1	87-Up	74554E	61971F
554B	Input Drum & Shaft no Pilot (300mm, 30 Spline Converter)	1	98-05	74554G	61971G
554B	Input Drum & Shaft no Pilot (300mm, 30 Spline Converter) (w/ Reluctor)	1	06-Up	74554GA	61971H
556E	Reverse Input Drum (w/ Check Ball) (Steel)	1	82-2/87	74556	61923
556E	Reverse Input Drum (No Check Ball) (Has Round Oil Holes In Bore)	1	3/87-93	74556A	61923A
556E	Reverse Input Drum (No Check Ball) (Large Feed Hole).....	1	3/87-Up	74556B	61923
564B	Piston Kit, Input Drum (Exc 2.8L) Neither Piston is Bonded.....	1	82-5/93	74564	N/A
564B	Piston Kit, Input Drum (Exc 2.8L) Both Pistons Bonded w/ Molded Rubber.....	1	5/93-Up	74564B	N/A
564B	Piston Kit, Input Drum (2.8L).....	1	82-Up	74564A	N/A
566E	Piston Kit, Reverse Input Drum (Aluminum, 3 Clutch)	1	2/87-96	74566A	N/A
566E	Piston Kit, Reverse Input Drum (Aluminum, 4 Clutch)	1	2/87-96	74566AA	N/A
567G	Piston Kit, Reverse Clutch (Exc 2.8L)	1	2/87-Up	74567B	61921A
854	Drum Saver Kit, Reverse Input	1	2/87-02	74854K	N/A
PLANETS					
582C	Front (w/ Round Washers) (Can Use 74582A)	1	82-Up	74582	61982
582C	Front (w/ Batwing Washers) (Can Use 74582)	1	82-Up	74582A	61982A
582C	Front (5 Pinion) (Retros All)	1	82-Up	74582B	61982B
582C	Planet Kit (4 Pinion) (Planets, Sun Gears, Ring Gears)	1	01-Up	74583C	K61910K
582C	Planet Kit, Front (4 Pinion w/ Shaft) (To Retro 82-00, also use 74241B Bearing)	1	01-Up	74582AK	DK61982C
582C	Planet Kit, Front (5 Pinion w/ Shaft) (To Retro 82-00, also use 74241B Bearing)	1	01-Up	74582CK	DK61982D
584G	Rear (w/ Round Washers) (Can Use 74584B).....	1	82-Up	74584	61907
584G	Rear (w/ Bat Wing Washers & w/ Oil Slinger) (Can use 74584B).....	1	82-Up	74584A	61907A
584G	Rear (w/ Bat Wing Washers w/o Oil Slinger) (Can use 74584A)	1	82-Up	74584B	61907
584G	Rear (5 Pinion) Retro-Fits	1	82-Up	74584C	61907B
592C	Ring Gear w/ Shaft, Front (1 3/8" Long Clutch Spline).....	1	82-Up	74592BK	61994
592C	Ring Gear, Front (1 3/8" Long Clutch Spline).....	1	82-Up	74592	N/A
592C	Ring Gear, Front (1 1/2" Long Clutch Spline).....	1	82-Up	74592A	N/A
592C	Ring Gear, Front (1 5/8" Long Clutch Spline).....	1	82-Up	74592B	N/A
594G	Ring Gear, Rear	1	82-Up	74594A	61916
602C	Hub w/ Shaft, Reaction Carrier (Washer Type)	1	82-Up	74602	61996
602C	Hub w/ Shaft, Reaction Carrier (Bearing Type)	1	93-Up	74602A	61996A
602C	Shaft Only, Reaction Carrier (Washer Type)	1	82-Up	74602-1	61996
604G	Hub, Support Internal Reaction Gear Early (Can Use 74604A).....	1	82-Up	74604	61918
604G	Hub, Support Internal Reaction Gear Late (Cut For Oil Slinger).....	1	82-Up	74604A	61918
N.I.	Pin, Rear Plan Pinion (Inside Pinion Gears) (4 Per Pack)	1	82-Up	74584A-3	N/A
N.I.	Pinion Gear Kit, Rear Planet Late (4 Gears; 4 Pins; 80 Needles; 16 Washers)	1	82-Up	74584A-7	N/A

700-R4, 4L60E

TH700-R4(MD8), 4L60 4L60E(M30), 4L65E(M32), 4L70E(M70)

ILL.	DESCRIPTION	QTY.	YEAR	PART NO.	REFERENCE NO.
SUN GEARS, SHELLS & SUPPORTS					
612C	Sun Gear, Input (can use 74612B) (no bevel).....	1	82-Up	74612A	61993
612C	Sun Gear, Input (can use 74612A) (tab type with bevel).....	1	82-Up	74612B	N/A
614C	Sun Gear, Reaction (Rear).....	1	82-Up	74614	61997
624C	Shell, Reaction Sun (Washer Type w/ 4 Washer Holes).....	1	82-Up	74624	61903
624C	Shell, Reaction Sun (Bearing Type, No Washer Holes).....	1	01-Up	74624D	61903D
624C	Shell, Reaction Sun (The Beast) (incl. Special 4 Tang Washer).....	1	82-Up	74624A	61903B
624C	Sun Gear & Shell, Reaction (w/ Shell, Shaft & Bearing).....	1	02-Up	74624CK	DK61996
630G	Center Support, Outer Race (Narrow Sprag Type).....	1	82-85	44630	N/A
630G	Center Support, Outer Race (Wide Sprag Type).....	1	86-Up	74630A	DK61955
631	Center Support Assembly (Narrow Sprag Type).....	1	82-85	44631	35727
631	Center Support Assembly (Wide Sprag Type).....	1	86-Up	74631A	N/A
639G	Clip, Low/ Reverse (Anti-Clunk Spring).....	1	82-Up	74639	61915
SPRAGS					
654G	Sprag, Low/ Reverse (Narrow).....	1	82-86	44654	35503H
654G	Sprag, Low/ Reverse (Wide).....	1	87-96	74654A	61503
658F	Sprag, Forward Clutch (26 Elements).....	1	L82-86	74658	61725
658F	Sprag, Forward Clutch (29 Elements) Replaces 28 Element Sprag.....	1	87-E95	74658B	61725A
658F	Sprag, Forward Clutch (29 Elements, Single Cage).....	1	L95-Up	74658C	61725S
648F	Sprag Assembly, Forward Clutch (29 Elements, Dual Cage) (may not include Sprag) .	1	87-E95	74648B	K61725A
648F	Sprag Assembly, Forward Clutch (29 Elements, Single Cage) (may not include Sprag) .	1	L95-Up	74648C	DK61725A
SHAFTS					
678D	Output Shaft, 700-R4 13 1/4" Long (4wd, 2.8L).....	1	82-93	74678B	61995B
678D	Output Shaft, 700-R4 13 3/4" Long (4wd Exc 2.8L).....	1	82-93	74678C	N/A
678D	Output Shaft, 4L60E, 4L65E 13 1/4" Long (4wd).....	1	93-Up	74678BA	61995C
678D	Output Shaft, 4L60E, 4L65E 18 1/4" Long.....	1	93-Up	74678AA	61995A
847D	Pick-Up Wheel (40 T).....	1	82-91	D74847P	61992
GOVERNORS					
680D	Governor, w/ .108" Square Weight (Gas 8 Cyl).....	1	82-93	74680A	61931B
680D	Governor, w/ .158" Square Weight (Gas 6 & 8 Cyl).....	1	82-93	74680	61931
680D	Governor, w/ .180" Square Weight (Diesel).....	1	82-93	74680B	61931A
681	Governor Kit, Springs & Weights (Superior).....	1	82-93	44681-4K	K61931S
684D	Gear, Governor Gear Kit.....	1	82-93	74684	K61411
686D	Cover, Governor.....	1	82-93	44686	61932
687D	Clip, Holds Governor Cover on.....	1	82-93	74687	61956
688	Clip, Speed-O Drive Gear.....	1	82-93	74688	34226
VALVE BODIES					
740D	Valve Body (Premium) (Non Auxiliary) 700-R4.....	1	L87-92	74740-7	P61990A
740D	Valve Body (Premium) (Auxiliary) 700-R4.....	1	L87-92	74740-4	P61990B
740D	Valve Body (Premium) (Auxiliary) 700-R4.....	1	1993	74740-8	P61990C
740D	Valve Body (Premium) (Non PWM).....	1	93-94	74740-3	P61990E
740D	Valve Body (Premium) (PWM).....	1	1995	74740-2	P61990G
740D	Valve Body (Premium) (PWM).....	1	96-E00	74740-1	P61990H
740D	Valve Body (Premium) (w/ Full Annular TCC).....	1	L00-02	74740-5	P61990J
740D	Valve Body (Premium).....	1	03-Up	74740-6	P61990K
VALVE BODY COMPONENTS					
744D	Auxiliary Valve Body, Aluminum 700-R4.....	1	L87-93	74744	N/A
741H	Accumulator Assembly (.315" Valve, Sleeve, Plug, & 3 Springs).....	1	82-Up	74741EBK	K61943
741H	Accumulator Assembly (.330" Valve, Sleeve, Plug, & 3 Springs).....	1	82-Up	74741EAK	K61943A
741H	Accumulator Assembly (.341" Valve, Sleeve, Plug, & 3 Springs).....	1	82-Up	74741EK	K61943B
741H	Check Ball, Valve Body (Brass) (3/8").....	AR	82-Up	74741-5	N/A
741H	Check Ball, Valve Body (Steel) (1/4").....	AR	82-Up	44741-5	13924S

TH700-R4(MD8), 4L60 4L60E(M30), 4L65E(M32), 4L70E(M70)

ILL.	DESCRIPTION	QTY.	YEAR	PART NO.	REFERENCE NO.
VALVE BODY COMPONENTS (Cont.)					
741H	Isolator Valve Sleeve Repair, 4L60E (requires T-77754-RM5 Reamer)	1	93-Up	74741Q-2	K61944C
741H	Kit, 4-3 Sequence & Relay Valves End Plug (requires T-77964-RM2)	1	82-Up	74741ARK	K61966E
741H	Kit, 4-3 Sequence Valve (requires T-77754-RM)	1	82-Up	74741RK	K61966
741H	Kit, Lock-up In 4th Gear Only, 700-R4 (In VB) (1 Valve, 1 Sleeve, 1 Spring).....	1	82-93	D74741VH	D61970
741H	Kit, Lock-up In 4th Gear Only, 700-R4 (In VB) (2 Valves, 1 Sleeve, 1 Spring).....	1	82-93	A74741VH	K61970
741H	Pin, Holds Valve Sleeves in Valve Body, 700-R4.....	1-10	82-93	74741-6	N/A
741H	Piston, Forward Clutch Accum (Pinless) 4L60E	1	93-Up	74741GAK	K61987L
741H	Piston, Forward Clutch Accum, 4L60E (in Valve Body) Aluminum	1	93-Up	74741G	61987A
741H	Piston, Forward Clutch Accum, 4L60E (in Valve Body) Plastic	1	93-Up	74741FA	61987
741H	Plate Saver (Between Accum Cover to Valve Body Plate)	1	82-Up	74741PS	61988
741H	Plug, Forward/Reverse Abuse Bore, 4L60E.....	1	93-Up	74741-6A	61946
741H	Repair Kit, Fixes 5 Valve Body Plate Holes Most w/ 1/4" Check Balls	1	82-Up	VB-101	96-350VB
741H	Sleeve, Boost Valve Plunger in Valve Body, 700-R4 (Superior)	1	82-93	74741B	61967
741H	Spring & Stop Kit, 3-2 Downshift, 4L60E (Fixes 3 Transmissions).....	1	93-Up	74741H	K61874
741H	Spring, 3-2 Control Valve, 4L60E.....	1	93-Up	74741G-3	61883
741H	Spring, Anti-Stick Throttle Valve Spring, 700-R4 (Silver)	1	82-93	74741N-3	61975
741H	Spring, TCC Regulator (PWM) 4L60E	1	93-Up	74741Q-3	61944S
741H	Spring, Throttle Valve (Short) 700-R4.....	1	82-93	74741BA	61975A
741H	Spring, Throttle Valve Plunger, 700-R4.....	1	82-93	74741NA-3	61967S
741H	Throttle Valve Plunger & Sleeve Kit (93 Version) 700-R4.....	1	82-93	74741NAK	K61967
741H	Throttle Valve Plunger & Sleeve Kit (94 Version) 700-R4.....	1	82-93	74741NBK	K61967A
741H	Throttle Valve Plunger & Sleeve Kit (Hi-Perf) 700-R4.....	1	82-93	74741NCK	K61967D
741H	Valve Body Clip, Most Locations (10 Per Bag)	1	82-Up	74741-4	61973
741H	Valve Body Kit, Hydraulic Lock-up, 700-R4	1	82-93	74741VK	N/A
741H	Valve Kit, Forward / Reverse Abuse Valve, 4L60E.....	1	93-Up	74741HAK	K61946
741H	Valve Kit, Lock-Up Speed Calibration Kit, 700-R4.....	1	82-93	74741VH	K61970S
741H	Valve Kit, TCC Reg w/ Sleeve (T-77754-R2 Reamer Required)	1	93-97	74741QK	K61944A
741H	Valve Kit, TCC Reg w/ Sleeve (T-77754-R2 Reamer Required)	1	98-Up	74741QAK	K61944
741H	Valve Kit, TCC Upgrade For SRTA Rebuilt Valve Bodies, 4L60E	1	95-Up	T74741CK	K61944T
741H	Valve, 4th Shift, 700-R4 (Allows 3-4 Shift At Max. Throttle) (TRANSGO®).....	1	82-93	74741-1	K61908F
741H	Valve, Converter Clutch, 700-R4	1	82-93	74741C-1	N/A
741H	Valve, Oversize Throttle Valve, 700-R4 (T-77968-RM Reamer Required)	1	82-93	74741N-1N	61975V
741H	Valve, TCC Replacement to Fix P1870 Code 7, 4L60E.....	1	95-00	A74741QB	N/A
741H	Valve, TCC Replacement to Fix P1870 Code 7, 4L60E.....	1	01-Up	A74741QC	N/A
741H	Valve, TCC Shift (In Valve Body Under 74741VH) 700-R4.....	1	82-93	74741CS-1	61972
VALVE BODY PLATES					
747D	Plate, Valve Body, 700-R4 (All 82-86 Plates Will Retro Fit)	1	82-86	74747AC	N/A
747D	Plate, Valve Body, 700-R4 (Universal - Replaces All 700-R4's) (Transgo)	1	82-93	74747U	61961R
747D	Plate, Valve Body To Case Separator, 4L60E (Transgo).....	1	93-94	74747EA	61961
747D	Plate, Valve Body To Case Separator, 4L60E (Transgo).....	1	1995	74747EB	61961A
747D	Plate, Valve Body To Case Separator, 4L60E (Transgo).....	1	96-05	74747EC	61961B
CASES & HOUSINGS					
760D	Case, 700-R4 (2wd) (Exc 2.8L) (Aux. Type)	1	L87-91	74760C	C700-2W
760D	Case, 700-R4 (4wd) (Exc 2.8L) (Aux. Type)	1	L87-91	74760E	C700-4W
760D	Case (1 Piece) (2wd) (All V-8 & 4.3L Full Size Truck) (Four 5mm Screw Dust Cover) . (w/o PRNDL Switch Hole)	1	92-95	74760G	C4L60
760D	Case (1 Piece) (2wd) (All V-8 & 4.3L Full Size Truck) (Four 5mm Screw Dust Cover) . (w/ PRNDL Switch Hole)	1	1996	74760GA	N/A
760D	Case (1 Piece) (2wd) (All V-8 & 4.3L Full Size Truck)	1	1996	74760GB	N/A
	(w/ PRNDL Switch & Shift Cable Bracket Bosses)				
761H	Case Fix, Center Support, Wide Sprag Type All Years	1	93-Up	74761D	K61995G
760D	Case (1 Piece) (4wd) All V-8 & (4.3L Full Size Truck) (Six 10mm Screw Dust Cover) .	1	92-95	74760H	N/A
760D	Case (1 Piece) (4wd) All V-8 & (4.3L Full Size Truck) (PRNDL Switch).....	1	1996	74760HA	N/A
760D	Case (1 Piece) (4wd) All V-8 & (4.3L Full Size Truck)	1	1996	74760HB	N/A
	(w/ PRNDL Switch & Shift Cable Bracket Bosses)				

700-R4, 4L60E

TH700-R4(MD8), 4L60 4L60E(M30), 4L65E(M32), 4L70E(M70)

ILL.	DESCRIPTION	QTY.	YEAR	PART NO.	REFERENCE NO.
CASES & HOUSINGS (Cont.)					
765H	Pan.....	1	82-96	74765	N/A
765H	Pan (Trucks & Vans)	1	97-Up	74765A	N/A
770H	Extension Housing 2wd (uses a Mount on the Bottom)	1	82-95	74770	N/A
770H	Extension Housing (No Mount or Bracket).....	1	82-95	74770A	N/A
770H	Extension Housing (No Mount or Bracket) Has Speed Sensor, 4 Bolts to Case.....	1	96-97	74770F	N/A
770H	Extension Housing (2 Hole Side Bracket Type)	1	93-95	74770B	N/A
770H	Extension Housing (2 Bolt Bottom Mount) Has Speed Sensor, 4 Bolts to Case.....	1	96-97	74770FA	N/A
770H	Extension Housing (2 Bolt Bottom Mount) 7 1/4" Long	1	93-95	74770	N/A
770H	Extension Housing (2 Bolt Bottom Mount) 9 5/8" Long (6 Bolts to Case).....	1	96-97	74770H	N/A
770H	Extension Housing (2 Bolt Bottom Mount & 3 Stabilizer Holes) 6 Bolts to Case.....	1	93-Up	74770J	N/A
770H	Extension Housing (3 Hole Side Bracket Type)	1	93-95	74770C	N/A
CASE & HOUSING COMPONENTS					
776	Bolt Kit, Bell Housing to Case, 4L60E (Package of 8 Bolts).....	1	93-Up	74776AK	N/A
776	Bolt Kit, Bell Housing to Case, 4L60E	1	93-Up	74776A	96-175
842H	Bracket, Holds Large Speed-O-Housing In Place.....	1	82-Up	74842	N/A
761H	Case Fix, Center Support, Narrow Sprag Type All Years.....	1	82-Up	44761E	K35995G
761H	Case Fix, Center Support, Wide Sprag Type All Years	1	82-Up	74761D	K61995G
761H	Case Saver, 4 Piece.....	1	82-Up	44761A	K35790A
761H	Case Saver, 1 Piece.....	1	82-Up	44761B	35790
854	Drum Saver Kit, Reverse Input.....	1	L87-02	74854K	N/A
774H	Gear Housing, 700-R4 w/ 34-39T Speedo Driven Gear (Plastic).....	1	82-93	44774BA	35227A
774H	Gear Housing w/ Seals, 700-R4 w/ 34-39T Speedo Driven Gear (Aluminum)	1	82-93	44774BAM	N/A
774H	Gear Housing w/ Seals, 700-R4 w/ 40-43T Speedo Driven Gear (Aluminum)	1	82-93	44774BM	N/A
847D	Pick-Up Wheel (40 T).....	1	82-Up	74847P	61992
SNAP RINGS					
861C	Holds 3-4 Pressure Plate In Input Drum	1	82-Up	74861	N/A
861C	Holds 3-4 Pressure Plate In Input Drum (.062)	1	82-Up	74861A	N/A
883C	Holds Center Support In Case	1	82-Up	74883	N/A
884G	Holds Sprag to Center Support.....	2	82-Up	44884	35560
886G	Low Reverse Spring Retainer.....	1	82-Up	74886	61421
888C	Reaction Sun Gear	1	82-Up	74888	N/A
889G	Holds Hub to Rear Ring Gear.....	1	82-Up	74889	61420
894C	Front Planet to Output Shaft.....	1	82-Up	74894	N/A
MISCELLANEOUS COMPONENTS					
900D	Servo Assembly, 2-4 (Cast # 553)	1	82-Up	74900	N/A
900D	Servo Assembly, 2-4 (Cast # 554)	1	82-Up	74900A	N/A
900D	Servo Assembly, 2-4 (Cast D758 # 8642093) (Corvette).....	1	82-Up	74900B	N/A
901D	Spring Kit, Servo Return (3 Springs) (Replaces A74901)	1	82-Up	A74901K	61707
901D	Spring Kit, Servo Return (3 Springs) (Superior).....	1	82-Up	A74901BK	N/A
902D	Piston, 4th Servo (Super Servo) (use with A74905H) (Superior)	1	82-Up	A74902H	N/A
902D	Piston, 4th Servo (Super Hold)	1	82-Up	74902H	K61989
366D	O-Ring Kit For S74902H.....	1	82-Up	74366AK	N/A
905D	Piston Kit, Corvette Package (Also incl 2nd Apply Piston, 2 Accum Pistons)	1	82-93	74905BAK	N/A
905D	Piston Kit, Package (Smallest Diameter) (Incl 2nd Apply Piston, No Accum Pistons) ..	1	82-Up	74905BK	K61986
905D	Piston Kit, Super 1-2 Servo	1	82-Up	74905H	K61986S
905D	Piston, Servo 2nd Apply (Cast # 093)	1	82-Up	74905B	61986-1
905D	Piston, Servo 2nd Apply (Cast # 553)	1	82-Up	74905	N/A
905D	Piston, Servo 2nd Apply (Cast # 554)	1	82-Up	74905A	K61986A
907D	Inner Housing, Servo (Donut) (Cast # 115).....	1	82-Up	74907B	61986-2
907D	Sleeve, Inner Housing Servo (Fits # 554 & Converts It to # 553).....	1	82-Up	74907A-2	N/A
908D	Pin, 2nd Apply (1 Ring)	1	82-Up	74908A	61957A
908D	Pin, 2nd Apply (2 Ring)	1	82-Up	74908B	61957
908D	Pin, 2nd Apply (3 Ring & 1 Wide Band)	1	82-Up	74908C	61957B

TH700-R4(MD8), 4L60 4L60E(M30), 4L65E(M32), 4L70E(M70)

ILL.	DESCRIPTION	QTY.	YEAR	PART NO.	REFERENCE NO.
MISCELLANEOUS COMPONENTS (Cont.)					
908D	Pin, 2nd Apply (Extendo) 700-R4	1	82-93	T74908	61875
908D	Pin, 2nd Apply (Extendo) 4L60E	1	93-Up	74908E	61875A
925D	Accumulator Piston Kit w/ 1-2 & 3-4 Piston & Seals, 4L60E	1	93-Up	74925EAK	DK61985A
926D	Spring, 1-2 Accumulator (No Color) Outer	1	82-Up	74926B	61706D
926D	Spring, 1-2 Accumulator (Green) Outer	1	82-Up	74926E	N/A
926D	Spring, 1-2 Accumulator (Orange, Cone Shaped) Outer	1	82-Up	74926A	61706B
926D	Spring, 1-2 Accumulator (Purple) Outer	1	82-Up	74926C	61706
926D	Spring, 1-2 Accumulator (Red) Outer	1	82-Up	74926D	61706C
926D	Spring, 1-2 Accumulator (White) Outer	1	82-Up	74926H	61706A
926D	Spring, 1-2 Accumulator (Yellow) Outer	1	82-Up	74926G	N/A
926D	Spring, 1-2 Accumulator (No Color) Inner, 4L60E	1	93-Up	74926F	N/A
926D	Spring, 1-2 Accumulator (Orange) Inner, 4L60E	1	93-Up	74926AA	N/A
926D	Spring, 1-2 Accumulator (White) Inner, 4L60E	1	93-Up	74926BA	N/A
927D	Piston, 1-2 & 3-4 Accumulator (.310" Pin Dia)	2	82-Up	74927	61985X
927D	Kit, 1-2 & 3-4 Accumulator Piston (.310" Pin Dia)	1	82-Up	A74927K	K61985
927D	Kit, 1-2 & 3-4 Accumulator Piston (.310" Pin Dia) (Pinless Design)	1	82-Up	74927K	K61985L
927D	Piston Kit, 1-2 Accumulator (.230" Pin Dia)	1	93-Up	74927BK	N/A
927D	Piston, 1-2 Accumulator (.230" Pin Dia)	1	93-Up	74927B	61985A
927D	Piston, 1-2 Accumulator (.236" Pin Dia) w/o Legs (Transgo)	1	03-Up	74927C	61985B
929D	Cover, 1-2 Accumulator, 700-R4	1	82-93	74929	61945
929D	Cover, 1-2 Accumulator (.230" Dia.) (Retros 91-93 by Using 74927B Piston) 4L60E ..	1	94-01	74929B	61945B
929D	Cover, 1-2 Accumulator	1	02-Up	74929C	N/A
931	Spring, In Auxiliary Valve Body (Brown)	1	87-93	74931A	N/A
934D	Cover, Auxiliary Valve Body (3 Bolt)	1	87-93	74934A	N/A
935D	Accumulator Assembly, 3-4 Accumulator, 700-R4	1	82-93	74935	N/A
935D	Accumulator Assembly, 3-4 Accumulator, 4L60E	1	93-Up	74935B	N/A
936D	Spring, 1-2, 3-4 Accumulator Hi-Performance	1	82-93	74936H	61706S
936D	Spring, 3-4 Accumulator	1	82-Up	74926	N/A
937D	3-4 Accumulator Sleeve Kit (w/ O-Ring)	1	82-Up	74937-1K	K61985S
937D	Piston, 1-2 & 3-4 Accumulator	1	82-93	74927	61985X
937D	Piston, 3-4 Accumulator (.230" Pin Dia)	1	93-Up	74937B	N/A
938D	Pin, 3-4 Accumulator (.310" Pin Dia)	1	82-Up	74938	D61985P
938D	Pin, 1-2 & 3-4 Accumulator (Oversized) (4 Per Kit) 700-R4	1	82-93	74938X	61985P
938D	Pin, Forward Accumulator (Oversized) (4 Per Kit) 4L60E	1	93-Up	74938XE	61987P
938D	Reamer Kit, 1-2 & 3-4 Accumulator (Oversized) 700-R4	1	82-93	74938XK	T-9157
938D	Reamer Kit, Forward Accumulator (Oversized) 4L60E	1	93-Up	74938XEK	T-9146
958D	Yoke Tube	1	82-Up	74958	61930A
960B	Piston, 4th Clutch	1	82-93	74960	N/A
960B	Piston, 4th Clutch (w/ Molded Rubber)	1	94-Up	74960E	61952
963B	Piston Housing, Forward Clutch	1	82-Up	74963	61941
964B	Piston & Retainer Kit, Forward Clutch	1	82-93	74964K	N/A
964B	Piston, Forward Clutch (w/ Molded Rubber)	1	94-Up	74964A	61962
966E	Piston, Reverse Input Clutch (Aluminum, 3 Clutch)	1	L87-96	74966A	N/A
967G	Piston Kit, Low/ Reverse Clutch (Exc 2.8L)	1	82-00	74967K	N/A
967G	Piston, Low/ Reverse Clutch (8 Cyl) 700-R4	1	82-86	74967	61921
967G	Piston, Low/ Reverse Clutch, 4L60E	1	93-Up	74967E	61921P
969B	Piston, Overrun Clutch (w/ Molded Rubber)	1	97-Up	74969A	61963
969B	Piston Kit, Overrun Clutch (w/ Molded Rubber)	1	82-Up	74969AK	K61953
970	Release Spring Assembly, 3-4 Clutch Load	5	87-Up	74970	61999
971B	Spring Kit, 4th & Overrun Clutch (TRANSGO®)	1	82-Up	74971K	K61908S
971B	Retainer w/ Spring, 3-4 Input Clutch	1	82-95	74971	K61908S
971B	Retainer w/ Spring, 3-4 Input Clutch (w/ 4 Inner Lock Tabs)	1	96-Up	74971A	N/A
976E	Retainer w/ Spring, Reverse Input Clutch	1	82-Up	74976	N/A
977G	Retainer w/ Spring, Low/ Reverse Clutch	1	82-Up	74977	61984
979B	Retainer w/ Spring, Forward Clutch Return	1	82-93	74964K	N/A
979B	Retainer w/ Spring, Forward Clutch Return	1	94-Up	74979B	61953A
981F	Retainer, 3-4 Clutch 4 Tab (Tin)	1	82-Up	74981	N/A
981F	Retainer, 3-4 Clutch 5 Tab (Tin) 700-R4	1	82-93	74981A	N/A
981F	Retainer, 3-4 Clutch 5 Tab (Tin) 4L60E	1	93-Up	74981B	N/A

700-R4, 4L60E

TH700-R4(MD8), 4L60 4L60E(M30), 4L65E(M32), 4L70E(M70)

ILL.	DESCRIPTION	QTY.	YEAR	PART NO.	REFERENCE NO.
MISCELLANEOUS COMPONENTS (Cont.)					
993	Manual Valve Link (3 1/8" Long)	1	82-Up	74993L	61935
993	Manual Valve Link (2 1/8" Long) 4L60E.....	1	93-Up	74993LA	61935A
993	Manual Valve Link (5 3/8" Long) 4L60E.....	1	96-Up	74993LB	N/A
996D	Cooler Line Fitting, 5/16" x 1/4"	2	82-95	M462C	96-132
996D	Cooler Line Fitting, 5/16"	2	82-95	74996	N/A
996D	Cooler Line Fitting (Push-In Type)	2	96-97	74996B	96-460
997D	Wire Link, Shortened T.V. Allows Re-Adjustment.....	1	82-93	74997-7	61958S
997D	Wire Link, T.V. Cable to Linkage	1	82-93	D74997-7	61958
Tool	Rear Clutch Spring Compressor.....	1	82-Up	T-0151	T-0151
Tool	Front Pump Alignment Band (Can use T-172)	1	82-Up	T-1097	T-1097
Tool	Stator Shaft Teflon Seal Installer / Resizer	1	82-Up	T-1503	T-1503
Tool	Overrun Clutch Inner Lip Seal Installer	1	82-Up	T-1527	T-1527
Tool	Forward Clutch Inner Lip Seal Installer	1	82-Up	T-1528	T-1528
Tool	Torx Bit, Bell Housing - 4L60E	1	93-Up	T-1550	T-1550
Tool	Intermediate Band Apply Pin Gauge	1	82-Up	T-1561	T-1561
Tool	Front Pump Spring Loader Tool.....	1	82-Up	T-1703	T-1703
Tool	2-4 Servo Cover Depressor (For Use With Pan On)	1	82-Up	T-1735	T-1735
Tool	Electronic Connector Remover	1	82-Up	T-TGM-HR	T-9138



MK2, MH5 CORVETTE OVERDRIVE

GM OVERDRIVE 4 SPEED MANUAL

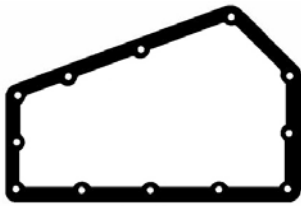

GM Overdrive for 1984-Up
Corvette w/4 Spd. Manual
Transmission

ILL.	DESCRIPTION	QTY.	YEAR	PART NO.	REFERENCE NO.
MASTER OVERHAUL KITS (WITH STEELS)					
006	MH5, MK2 (Doug Nash) (w/ .071" Steels)	1	84-85	194006	K3000
006	MH5, MK2 (Doug Nash) (w/ .061" Steels)	1	86-Up	194006B	N/A
LESS STEEL KITS					
004	MH5, MK2 (Doug Nash)	1	84-Up	194004	K3000-LS
OVERHAUL KITS (W/ RINGS & SEALS)					
002	MH5, MK2 (Doug Nash)	1	84-Up	194002	N/A
FILTER KITS					
011	MH5, MK2 (Doug Nash)	1	84-Up	194011	FK30710
FILTERS					
010	MH5, MK2 (Doug Nash)	1	84-Up	106010A	6582D
BUSHINGS					
066	Extension Housing (Babbit)	1	84-Up	44066	8008A
066	Extension Housing (Bronze)	1	84-Up	44066B	8008
METAL CLAD SEALS					
070	Input Sun Gear	1	84-Up	194070	30151
074	Rear	1	84-Up	44074	8850B
FRICITION PLATES					
100	Overdrive	4-5	84-Up	194100	N/A
106	Direct	5-6	84-Up	194106	N/A
STEEL PLATES					
120	Overdrive (.061") (24 T)	5	84-Up	194120A	N/A
120	Overdrive (.071") (24 T)	4	84-Up	194120	N/A
126	Direct (.061") (24 T)	4	84-Up	194126A	N/A
126	Direct (.071") (24 T)	6	84-Up	194126	N/A
GASKETS & O-RINGS					
300	Pan Gasket (Cork)	1	84-Up	194300	30500
300	Pan Gasket (Fiber)	1	84-Up	194300F	30500F
SPRAGS					
658	Sprag, Direct	1	84-Up	74658	61725

MK2/MH5

4L80E (MT1) 4L85E (MN8)

4 SPEED w/O.D.

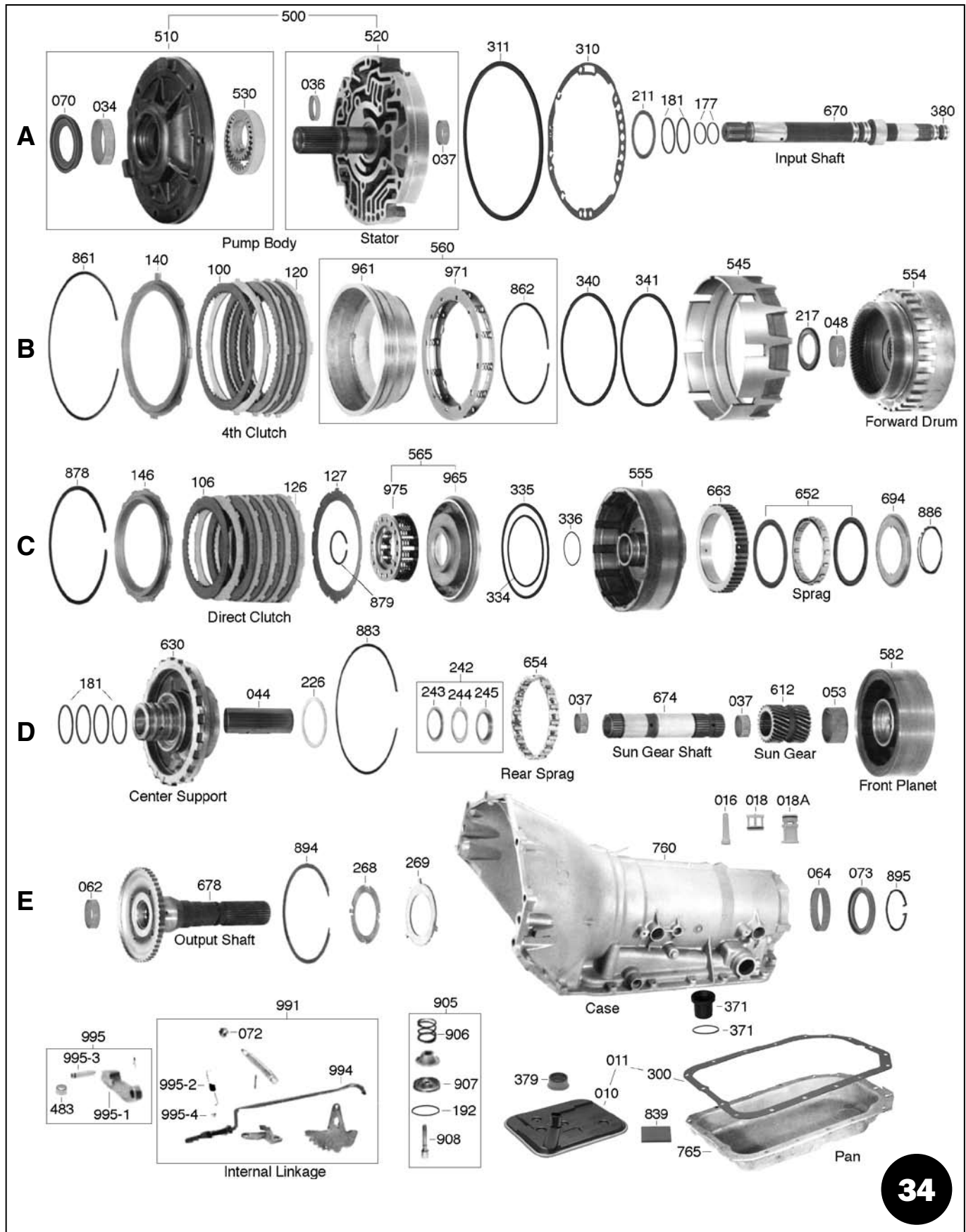

4 SPEED w/O.D.

4L80E (MT1) 4L85E (MN8)

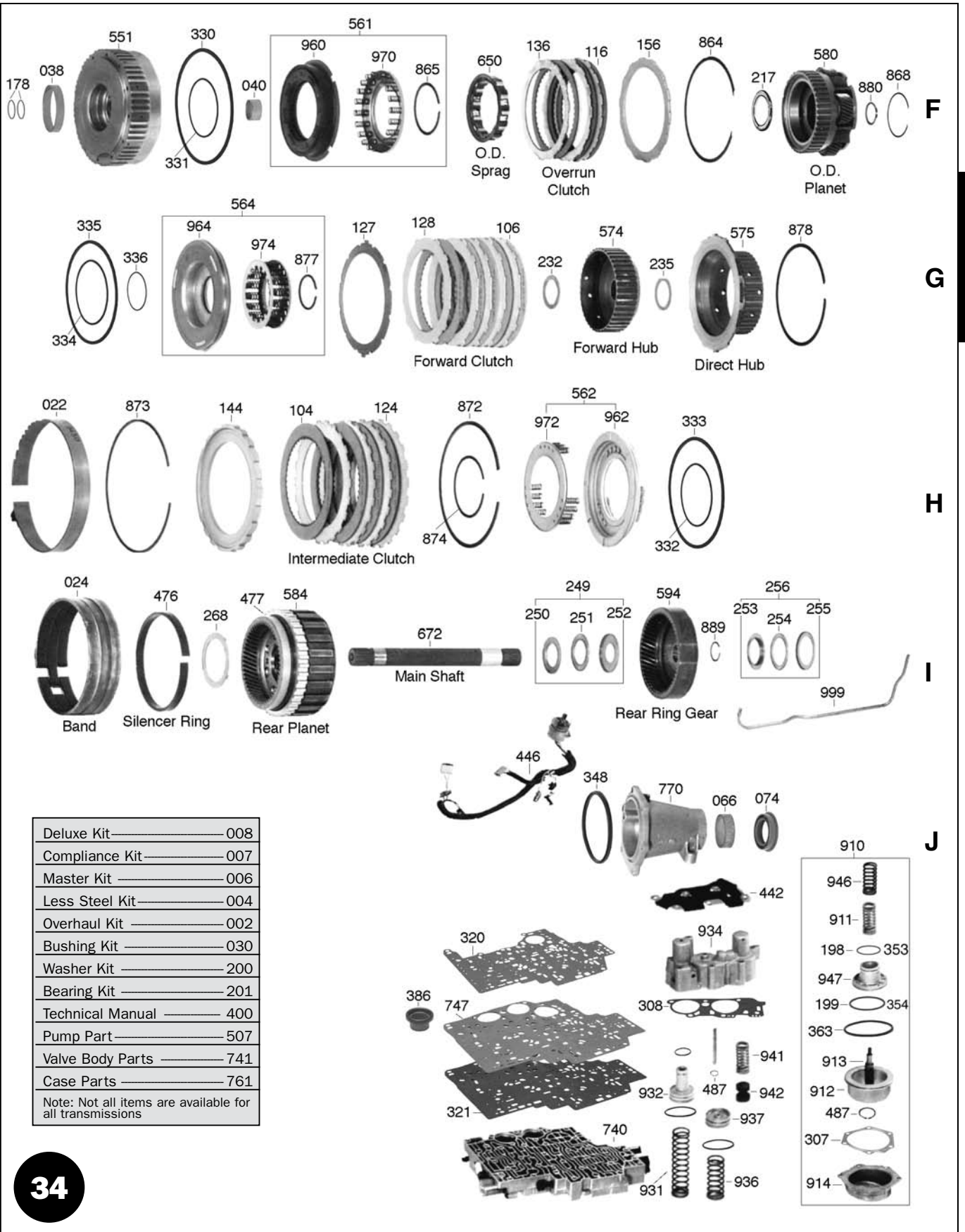

Deluxe Kit	008
Compliance Kit	007
Master Kit	006
Less Steel Kit	004
Overhaul Kit	002
Bushing Kit	030
Washer Kit	200
Bearing Kit	201
Technical Manual	400
Pump Part	507
Valve Body Parts	741
Case Parts	761

Note: Not all items are available for all transmissions

4L80E

F

G

H

I

J

4L80E (MT1) 4L85E (MN8)

4 SPEED w/O.D.



34010E



34010EA

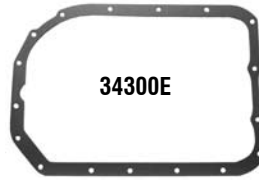

34300E

Chevrolet & GMC Trucks & Vans, G10, G30, Astro, Safari, Blazer, GMC Yukon, Suburban, C & K Pickups, Isuzu NPR Pickup 91-99, Jaguar XJS, XJ12

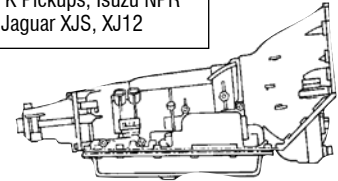

Rear Wheel Drive

ILL.	DESCRIPTION	QTY.	YEAR	PART NO.	REFERENCE NO.
DELUXE KITS (SUPER KITS) (1)					
008J	4L80E (w/ Bonded Piston)	1	91-96	34008EX	K3400E-R
008J	4L80E (w/ Bonded Pistons & Turbulator Steels)	1	97-Up	34008EBX	K3400F-R
COMPLIANCE KITS (CALIFORNIA KITS) (1)					
007J	4L80E (w/ Bonded Piston)	1	91-96	34007EX	CK3400E-R
007J	4L80E (w/ Bonded Pistons)	1	97-Up	34007EBX	CK3400F-R
MASTER OVERHAUL KITS (WITH STEELS) (1)					
006J	4L80E (w/ Bonded Piston)	1	91-96	34006EX	K3400E
006J	4L80E (w/ Bonded Pistons & Turbulator Steels)	1	97-Up	34006EBX	K3400F
LESS STEEL KITS (1)					
004J	4L80E (w/ Bonded Piston)	1	91-96	34004EX	K3400E-LS
004J	4L80E (w/ Bonded Pistons)	1	97-Up	34004EBX	K3400F-LS
OVERHAUL KITS (W/ RINGS & SEALS) (1)					
002J	4L80E (w/o Bonded Piston)	1	91-Up	34002EX	K34900E
002J	4L80E (w/o Bonded Piston)	1	97-Up	34002EAF	F34900F
GASKET & SEAL KITS (W/O RINGS & SEALS) (1)					
000J	4L80E (w/o Bonded Piston)	1	91-Up	34000EX	K34900E-1
FILTER KITS (1)					
011E	4L80E (91-96 Exc Jaguar)	1	91-96	34011E	FK34661F
011E	4L80E (91-96 Jaguar)	1	91-96	34011EJ	N/A
011E	4L80E	1	97-Up	34011EA	FK34661G
<p>(1) - "X" suffix kits do not include a Pan Gasket. To order Kits with Fiber pan gaskets, add an "F" suffix.</p>					
FILTERS					
010E	4L80E	1	91-96	34010E	34661F
010E	4L80E	1	97-Up	34010EA	34661G
016E	Screen, PWM/TCC Solenoid-In Case (Thimble Type)	1	91-Up	34016	34713C
018E	Screen, Force Motor/Pressure Control	1	91-Up	34018	34713B
018E	Screen, Shift Solenoid (Long) (In Valve Body w/ O-Ring)	1	91-Up	34018A	34713A
BANDS					
Prefix Key: B = Borg Warner, A = OEM (Exc BW), N = All Other New, R = Relined					
022H	Front (1" Wide) (Used w/ Front Servo Piston w/ 2.530" Pin)	1	91-98	34022	34325
022H	Front (1 1/4" Wide) (Used w/ Front Servo Piston w/ 2.730" Pin)	1	99-Up	34022E	34325B
024I	Rear (Reverse)	1	91-Up	34024	34510-RL
024I	Rear (Reverse) (Retro's All)	1	91-Up	34024E	B34510
BUSHINGS					
030J	Bushing Kit	1	91-96	34030E	K34903E
030J	Bushing Kit	1	97-Up	34030EA	K34903F

4 SPEED w/O.D.

4L80E (MT1) 4L85E (MN8)

ILL.	DESCRIPTION	QTY.	YEAR	PART NO.	REFERENCE NO.
BUSHINGS (Cont.)					
034A	Pump (.550" Wide) (OEM Style)	1	91-96	34034B	34001
034A	Pump (.700" Wide)	1	97-Up	34034BA	34001C
036A	Stator Support (Front)	1	91-Up	34036B	34002A
036A	Stator Support (Front) (Extra Wide) (Bag of 4)	1	91-Up	34036S	34002S
037A	Stator Support (Rear)	1	91-Up	34037B	34002B
037D	Sun Gear Shaft	1-2	91-Up	34037	34002
037D	Sun Gear Shaft w/ Oil Grooves	1	97-Up	34037C	34002C
038F	Overrun Drum (Front) 2.001" OD	1	91-Up	34038	34007
040F	Overrun Drum (Rear)	2	91-Up	34037	34002
044D	Center Support	1	91-E97	34044B	34003A
044D	Center Support, w/ Center Lube Circuit 4.02" Long	1	L97-Up	34044C	34003B
048B	Forward Drum	1	91-Up	34048	34009
053D	Front Planet	1	91-Up	34053	34008
062E	Output Shaft (Narrow)	1	91-Up	34062B	34004A
064E	Case (OEM Style)	1	91-92	34064B	34006A
064E	Case ("No Walk-Out") (Sonnax)	1	91-Up	34064BA	N/A
064E	Case (OEM Style) (2.128" Bronze)	1	93-Up	34064BC	34006X
066J	Extension Housing (2.02" x 1.00")	1	91-03	34066C	34005C
066J	Extension Housing (Not Yet Available)	1	04-Up	34066E	N/A
METAL CLAD SEALS					
070A	Front	1	91-Up	34070E	38151E
072	Linkage Shaft	1	91-Up	44072	38511
073	Case Seal	1	91-Up	34073E	34745
074J	Rear (2.700" OD) (w/o Boot)	1	91-Up	34074	34743D
074J	Rear (2.700" OD) (w/ Boot)	1	91-Up	34074EB	34743F
074J	Rear (2.874" OD)	1	91-Up	34074EA	34743E
079	Cooler Line Fitting to Center Support	1	91-Up	34079	34746
FRICTION PLATES					
100B	4th Clutch	4	91-Up	34100	34504
100B	4th Clutch (Hi-Performance) (Blue)	4	91-Up	R34100HP	34504X
104H	Intermediate (.080")	4	91-95	34104E	34404D
104H	Intermediate (.071") (Hi-Energy)	4	96-Up	34104EA	34404H
104H	Intermediate (.070") (Hi-Performance) (Blue)	4	96-Up	R34104AHP	34404AX
106C	Forward & Direct	10-11	91-95	34106	34304
106C	Forward & Direct (Hi-Energy)	10-11	96-Up	34106E	34304H
106C	Forward & Direct (Hi-Performance) (Red)	10-11	91-Up	A34106AH	34304RX
116F	Overrun	3	91-Up	34116	34604
116F	Overrun (Hi-Performance) (Blue)	3	91-Up	R34116HP	34604X
STEEL PLATES					
120B	4th Clutch	4	91-96	34120	34505
120B	4th Clutch (Turbulator w/ Holes)	4	97-Up	34120B	34505B
124H	Intermediate (.076")	4	91-Up	34124E	34405A
124H	Intermediate (.076") (Kolene)	4	91-Up	34124H	34405AK
124H	Intermediate (.076") (Kolene) w/ Holes	4	91-Up	34124J	34405HK
125	Intermediate Cushion (Waved)	1	96-Up	34125A	34420B
126C	Direct (.090")	5	91-Up	34126A	34305C
126C	Direct (.090") (Kolene)	5	91-Up	34126D	34305CK
126C	Direct (.090") (Kolene) w/ Holes	5	97-Up	34126E	34305CH
126C	Direct (.060")	5	91-Up	34126B	34305X
126C	Direct (.060") (Kolene)	5	91-Up	34126C	34305KX
128G	Forward (.077")	5	91-Up	34128	34305A
128G	Forward (.077") (Kolene)	5	91-Up	34128B	34305AK
128G	Forward (.077") (Kolene) w/ Holes	5	97-Up	34128C	34305AH
127G	Forward & Direct (5.7L) (14 T) (Waved)	1	97-Up	34127EB	N/A

4L80E

4L80E (MT1) 4L85E (MN8)

4 SPEED w/O.D.

ILL.	DESCRIPTION	QTY.	YEAR	PART NO.	REFERENCE NO.
STEEL PLATES (Cont.)					
127G	Forward & Direct Cushion (Dished)	1	91-Up	34127D	34305D
127G	Forward & Direct (6.5L) (6 T) (Waved)	1	97-Up	34127EA	34305F
127G	Forward & Direct (7.4L) (12 T) (Waved)	1	97-Up	34127E	34305E
136F	Overrun	3	91-96	34136	34605
136F	Overrun (Turbulator w/ Holes)	3	97-Up	34136B	34605B
PRESSURE PLATES					
Prefix Key: D = OEM, A = Aftermarket New, R = Remanufactured					
140B	4th Clutch (8 Lug)	1	91-98	34140	34715A
140B	4th Clutch (2 Lug)	1	99-Up	34140B	34715D
144H	Intermediate Clutch (w/ Lip)	1	91-98	34144B	34715C
144H	Intermediate Clutch (No Lip)	1	99-Up	34144C	34715F
146C	Direct Clutch	1	91-Up	34146B	34715B
156F	Direct, Overrun Clutch	1	91-Up	34156	34715
VALVE BODY RECALIBRATION KITS					
161	Vacuum Boost Valve Bypass Kit (Transgo®)	1	91-Up	T34161E	N/A
165J	Shift Kit®, 4L80E (Transgo®)	1	91-Up	T34165E	K34908E
165J	Valve Body Kit, 4L80E (Superior)	1	91-Up	S34165E	34C03
165J	Ring Kit, 4L80-HTRK (Transgo®)	1	91-Up	T34165ED	4L80E-HTRK
165J	Reprogramming Kit™, Hi-Perf/ HD Automatic w/ Complete Gear Control (Transgo®) .	1	91-Up	T34169E	4L80E-HD2
165J	Reprogramming Kit™, Stick Shift. Manual Shift Only (Transgo®)	1	91-Up	T34173E	4L80E-3
165J	Sure Cure Kit (Sonnax)	1	91-Up	S34174	34S01
SEALING RINGS					
175J	Ring Kit	1	91-Up	34175E	K34901F
177A	Turbine Shaft (To Stator Support) (Teflon)	2	91-Up	34177BT	34408T
178F	Turbine Shaft (To Forward Drum) (Teflon)	2	91-Up	34178BT	34409T
181A	Center Support Ring	4	91-Up	92181T	34407T
199J	Rear Accumulator (Outer) (Metal)	1	91-Up	34199A	34712A
199J	Rear Accumulator (Outer) (Teflon)	1	91-Up	34199AT	N/A
THRUST WASHERS					
200J	Washer Kit	1	91-Up	34200E	K34907E
200J	Washer Kit, Stator, 5 Selective Washers	1	91-Up	34211HK	N/A
211A	Stator .059" (Blue)	1	91-Up	34211HA	34208G
211A	Stator .075" (Red)	1	91-Up	34211HB	34208H
211A	Stator .091" (Brown)	1	91-Up	34211HC	34208J
211A	Stator .107" (Green)	1	91-Up	34211HD	34208K
211A	Stator .123" (Black)	1	91-Up	34211HE	34208L
226D	Center Support to Front Planet (Metal)	1	91-Up	34226	34401
226D	Center Support to Front Planet (Plastic)	1	91-Up	34226A	N/A
232G	Forward Drum to Forward Hub	1	91-Up	34232	34339
235G	Forward Hub to Direct Drum	1	91-Up	34235	34301
235G	Forward Hub to Direct Drum (.078") Oversized	1	91-Up	34235-078	34301C
235G	Forward Hub to Direct Drum (.094") Oversized	1	91-Up	34235-094	34301D
235G	Forward Hub to Direct Drum (Plastic)	1	91-Up	34235A	N/A
268I	Front Planet to Rear Planet (2 Tang, Plastic)	1	91-Up	34268A	34501C
268I	Front Planet to Rear Planet (4 Tang, Metal)	1	91-Up	34268	34501A
268I	Front Planet to Rear Planet (4 Tang, Plastic)	1	91-Up	54244A	32406A
268E	Output Shaft to Case (4-Tang) (Metal)	1	91-Up	34268	34501A
269E	Output Shaft to Case .076" (3-Tang)	1	91-Up	34269	34601
269E	Output Shaft to Case .084" (3-Tang)	1	91-Up	34269A	34601A
269E	Output Shaft to Case .092" (3-Tang)	1	91-Up	34269B	34601B
269E	Output Shaft to Case .100" (3-Tang)	1	91-Up	34269C	34601C
269E	Output Shaft to Case .108" (3-Tang)	1	91-Up	34269D	34601D
269E	Output Shaft to Case .116" (3-Tang)	1	91-Up	34269E	34601E

4 SPEED w/O.D.

4L80E (MT1) 4L85E (MN8)

ILL.	DESCRIPTION	QTY.	YEAR	PART NO.	REFERENCE NO.
THRUST WASHERS (Cont.)					
270	Shim, Output Shaft (.005")	1	91-Up	34270	34413
270	Case Saver (3 Tang Washer Replacement).....	1	91-Up	34270T	34601T
N.I.	Planet Kit, Overdrive Repair	1	91-Up	34204E	K34932
BEARINGS & RACES					
201J	Bearing Kit, Some (3 Bearings, 6 Races)	1	91-Up	34201A	K34907B
201J	Bearing Kit (may not include 34249AK 97-Up Bearing)	1	91-Up	34201E	N/A
217F	Bearing w/ Race, Overdrive Planet to Forward Drum	1	91-Up	54235A	32404
242D	Bearing w/ Race, Center Support to Sun Gear.....	1	91-Up	34242K	34920
249I	Bearing w/ Race, Sun Gear to Rear Ring Gear.....	1	91-96	34249K	34921
249I	Bearing w/ Race, Sun Gear to Rear Ring Gear (Replaces 34249K)	1	91-Up	34249AK	34921
250I	Race, Sun Gear to Rear Ring Gear (Front).....	1	91-Up	34250	34403
252I	Shim, Under Race # 252 to Reduce End Play (10 Per Kit).....	1	91-Up	34252S	34412
256I	Bearing w/ Race, Rear Ring Gear to Output Shaft.....	1	91-Up	34256K	34922
GASKETS & O-RINGS					
300E	Gasket, Pan (Exc Jaguar) (Fiber)	1	91-Up	34300EF	13955F
300E	Gasket, Pan (Exc Jaguar) (Bonded Rubber)	1	91-Up	34300EW	13955R
300E	Gasket, Pan (Jaguar) (Fiber).....	1	91-Up	34300EJF	13955JF
307J	Gasket, Rear Servo Cover.....	1	91-Up	34307A	3916AL
308J	Gasket, Accumulator.....	1	91-Up	34308	13822
310A	Gasket, Pump Cover to Case.....	1	91-Up	34310E	13898
311A	O-Ring, Front Pump	1	91-Up	74311	13794
312	O-Ring, Pump Bolt	1	91-Up	34312E	13268C
320J	Gasket, Case to Spacer Plate.....	1	91-Up	34320E	13824A
321J	Gasket, Valve Body to Spacer Plate.....	1	91-Up	34321E	13823A
334C	Bonded Lip Seal & Sleeve, Forward (Inner) (.050" Orifice) (can use 34334D or DA) ...	1	97-Up	34334DB	N/A
334C	Bonded Lip Seal & Sleeve, Forward (Inner) (.070" Orifice) (can use 34334D).....	1	97-Up	34334DA	N/A
334C	Bonded Lip Seal & Sleeve, Forward (Inner) (.086" Orifice)	1	97-Up	34334D	34918R
348J	O-Ring, Extension Housing.....	1	91-Up	34348	13271A
352	Seal, 1-2 Accumulator (Outer).....	1	91-Up	34352	13973
352	Seal, 1-2 Accumulator (Outer).....	1	91-Up	34352A	13972
363J	Seal, Rear Servo Piston.....	1	91-Up	34363	N/A
370	O-Ring, Output Speed Sensor (VSS).....	1	91-Up	34370	N/A
371D	Boot, Filler Tube	1	91-Up	44371B	13925
379D	Boot, Filter Neck.....	1	91-Up	84379	13987
380A	O-Ring, Lock-Up Input Shaft (Turbine Shaft).....	1	91-Up	34380E	13223
TECHNICAL MANUALS					
400J	Tech Manual	1	91-Up	34400E	34Y02
400J	Transmission Guide (GM).....	1	91-Up	34400B	N/A
400J	Rebuild Manual	1	91-Up	34400A	N/A
ELECTRICAL COMPONENTS					
410J	Switch, MLP Sensor (PRNDL) (One 7Pin & One 4 Pin Connector).....	1	95-Up	74410A	15D-327
410J	Switch, MLP (PRNDL) (One 11 Pin Connector).....	1	01-Up	74410B	15D-327A
420	Solenoid Master Kit	1	91-Up	34420K	31T-4L80
421	Solenoid, 1-2, 2-3, 3-4 Shift (Solenoids A or B).....	2	91-Up	34421	5R-149
421	Solenoid, 1-2, 3-4 Shift (Solenoid A Only) (OEM)	1	91-Up	D34421A	5A-149
422	Solenoid, 2-3 Shift (Solenoid B Only) (OEM).....	1	91-Up	D34422	5A-150
425	Solenoid, TCC, PWM.....	1	91-Up	34418	5A-151
429	Throttle Position Sensor (FIPL) Diesel.....	1	91-Up	34429	21A-310
431	Vacuum Pressure Control System (Repl EPC/Force Motor Solenoid) (Transgo).....	1	91-Up	34431E	48-MOD
435	Solenoid, EPC (1.5" Silver Can, 2 Prong Connector on the Bottom).....	1	91-93	34435	5D-152
435	Solenoid, EPC (1.5" Black Can, 2 Prong Connector on the Bottom).....	1	94-03	34435A	5D-152A
435	Solenoid, EPC (1.5" Silver Can, 2 Prong Connector on the Side).....	1	04-Up	34435C	5D-152C
435	Repair Kit, EPC Solenoid w/ Tool Kit (Transgo) 4 Repairs in One Kit.....	1	93-Up	T34435RK	5A-152K
435	Refill Kit for T34435RK.....	1	93-Up	T34435ARK	4L6-SOL-4

4L80E

ILL.	DESCRIPTION	QTY.	YEAR	PART NO.	REFERENCE NO.
ELECTRICAL COMPONENTS (Cont.)					
436	Speed Sensor, Input & Output (2 required)	2	91-Up	34436	20A-101
437	Sensor, Temperature.....	1	91-Up	34437	20D-100
442J	Switch, Manifold Pressure Switch.....	1	91-Up	34442	15D-135
444	Bracket, Wire Harness Connector	1	91-Up	34444-1	34889
445	Wire Harness, External Repair	1	94-Up	34445EK	35R-104
446J	Wire Harness, Internal & External Repair (Snap Type).....	1	91-03	34446K	35R-100
446J	Wire Harness, Internal Repair (Exc Jaguar)	1	91-03	34446	35R-103
446J	Wire Harness, Internal Repair (Exc Jaguar)	1	04-Up	34446C	35R-103B
446J	Wire Harness, Internal Repair (Jaguar Only).....	1	91-Up	34446J	35D-103J
446J	Repair Kit, Speed Sensor Connector	1	91-Up	74446CK	35R-216
843	Bracket, Solenoid Clip (EPC) (Bosch Design).....	1	91-Up	74487DA	34152
843	Bracket, Solenoid Clip (EPC) (Holley Design)	1	91-Up	34843E	34152A
N.I.	Tool, Wire Harness Removal Tool (Teckpak).....	1	91-Up	T-TGM-HR	T-9138
HARD PARTS					
Prefix Key: D = OEM, A = Aftermarket New, R = Remanufactured					
PUMPS					
500A	Pump, Two Cooler Fittings (Behind Bell)	1	91-96	34500E	34300
500A	Pump, One Cooler Fitting (Behind Bell)	1	97-03	34500EA	34300A
500A	Pump, No Cooler Fittings.....	1	04-Up	34500EB	N/A
507J	Plug, Pump Channel (converts 97-03 pump 34500EA to 04-Up 34500EB)	1	91-Up	34509	N/A
510A	Pump Body (Cast # 778 or 702)	1	91-Up	34510E	34210
510A	Pump Body (Cast # 302) 1997-Up (Retro Fits the 34510E if Used w/ 34520EC)	1	97-Up	34510EA	34210A
520A	Stator, Pump Cover (Cast # 263).....	1	91-Up	34520EA	34200E
520A	Stator, Pump Cover (Cast # 512) (Retrofits if Used w/ 34510EA)	1	97-Up	34520EC	34200F
PUMP COMPONENTS					
530A	Pump Gears.....	1	91-Up	34530A	K34201
507J	Boost Valve, Press Regulator.....	1	95-Up	34507RBK	K34968
507J	Boost Valve, Press Regulator (.855")	1	91-E95	34507BV	34966
507J	Boost Valve, Press Regulator (.830")	1	L95-Up	34507CV	34966A
507J	Boost Valve Sleeve, Press Regulator (.855")	1	91-E95	34507ER-2	34968
507J	Boost Valve Sleeve, Press Regulator (.830")	1	L95-Up	34507FR-2	34968A
507J	Valve, Press Regulator Line to Tube	1	95-Up	34507P-1	34887
507J	Valve & Sleeve, Boost Valve (w/ O-Ring).....	1	91-Up	34507RDK	K34968D
507J	Kit, Self-Regulating Boost Valve	1	91-Up	34507RAK	K34968S
507J	Plug, End TCC & Pressure Valves (5 Per Bag).....	1	91-Up	34507P-6	K34885
507J	Pressure Regulator Assembly.....	1	91-Up	34507EPK	K34967
507J	Pressure Regulator Valve Kit (Uses Sealing Rings S34507PK-1).....	1	91-Up	34507PK	K34979
507J	TCC Valve Bore Plug (Bag of 5)	1	91-Up	34507C-6	K34885C
507J	TCC Valve End Plug, .684" Diameter (Bag of 5).....	1	91-Up	34507C-6B	K34885A
507J	TCC Valve End Plug, Small (Bag of 5).....	1	91-Up	34507C-6A	K34885D
DRUMS & CLUTCH HUBS					
545B	4th Clutch (Cast # 8686123).....	1	91-Up	34545	34965
545B	4th Clutch (Cast # 24205817).....	1	99-Up	34545B	34965A
551F	Overrun Clutch w/ Sun Gear (Uses 34650 Roller Clutch) (Can use 34551AK)	1	91-E01	34551	34935
551F	Overrun Clutch w/ Sun Gear (Uses 34650A Roller Clutch) (Can use 34551AK)	1	L01-Up	34551A	34935A
551F	Overrun Clutch Kit w/ Sun Gear (Retros All 91-Up)	1	91-Up	34551AK	N/A
554B	Forward Clutch w/ Ring Gear (Lip Seal Type Piston).....	1	91-96	34554E	34945
554B	Forward Clutch w/ Ring Gear (Molded Piston Type)	1	97-Up	34554EA	34945A
555C	Direct (5 Clutch) (w/o Sprag)	1	91-Up	34555E	34950
555C	Direct Drum Kit (5 Clutch) (may not include Sprag)	1	91-Up	34555EK	N/A
574G	Clutch Hub, Forward Clutch.....	1	91-Up	34574	34946
574G	Clutch Hub, Forward Clutch (2.250" Tall, 1.200" Teeth)	1	91-Up	34574E	N/A

4 SPEED w/O.D.

4L80E (MT1) 4L85E (MN8)

ILL.	DESCRIPTION	QTY.	YEAR	PART NO.	REFERENCE NO.
DRUMS & CLUTCH HUBS (Cont.)					
575G	Clutch Hub, Direct Clutch 1.130" Thick Splines.....	1	91-Up	34575E	N/A
575G	Clutch Hub, Direct Clutch 1.160" Thick Splines.....	1	91-Up	34575EA	N/A
575G	Clutch Hub, Direct Clutch 1.230" Thick Splines.....	1	91-Up	34575	34947
560B	Piston Kit, 4th Clutch (Piston Cast # 8661271).....	1	91-Up	34560	N/A
561F	Piston Kit, Overrun Clutch	1	91-Up	34561	N/A
564G	Piston Kit, Forward Clutch (Alum. Piston Cast # 8675507)	1	91-Up	34564E	N/A
564G	Piston Kit, Forward Clutch (Steel Molded Rubber)	1	91-Up	34564EA	N/A
565C	Piston Kit, Direct (5 Clutch) (Alum No Ck Ball) (Cast 8625931) (Non Caged Spring)...	1	91-Up	34565B	N/A
565C	Piston Kit, Direct (5 Clutch) (Alum No Ck Ball) (Cast 8675510) (Caged Return Spr) ...	1	91-Up	34565E	N/A
PLANETS					
580F	Overdrive Planet Kit w/ Shaft (Retros all 91-00)	1	91-00	34580K	K34930
580F	Overdrive (3.215" Diameter Inside Race) (2 Missing Splines).....	1	91-92	34580	34930
580F	Overdrive (3.210" Diameter Inside Race) (4 Missing Splines).....	1	93-00	34580A	34930A
580F	Overdrive (3.010" Diameter Inside Race) (4 Missing Splines).....	1	01-Up	34580B	34930B
580F	Overdrive Planet Rebuild Kit (Pins, Rollers, Washers, Bearing)	1	01-Up	34580-7	K34932
582D	Front, 4 Gear (Angled Teeth) (No Tab Roller Clutch Type).....	1	91-95	34582A	34972
582D	Front, 4 Gear (Angled Teeth) (8 Tab Roller Clutch Type).....	1	95-Up	34582AA	34972
582D	Front, 4 Gear (Straight Teeth).....	1	91-98	34582S	34972A
582D	Front, 5 Gear	1	99-Up	34582AB	34972B
584I	Rear, 4 Gear (Angled Teeth) w/ Electric Pick-Up	1	91-98	34584E	34973
584I	Rear, 4 Gear (Straight Teeth) w/ Electric Pick-Up.....	1	91-98	34584SE	34973A
584I	Rear, 4 Gear (Straight Teeth) w/ Speed Sensor.....	1	91-98	34584S	N/A
584I	Rear, 5 Gear	1	99-Up	34584EA	34973B
594I	Ring Gear, Rear Planet (Angled Teeth).....	1	91-96	34594	N/A
594I	Ring Gear Kit w/ Mainshaft Hollow Type (Angled Teeth)	1	91-96	34594K	34974
594I	Ring Gear, Rear Planet (Angled Teeth) w/ 4 Notches	1	97-Up	34594B	N/A
594I	Ring Gear Kit w/ Mainshaft Hollow Type (Angled Teeth) w/ 4 Notches	1	97-Up	34594BK	34974B
594I	Ring Gear, Rear Planet (Straight Teeth).....	1	91-96	34594S	N/A
594I	Ring Gear Kit w/ Mainshaft Solid Type (Straight Teeth)	1	91-96	34594SK	34974A
SUN GEARS, SHELLS & SUPPORTS					
612D	Sun Gear, Angled Teeth (28 Splines Inside)	1	91-96	34612A	N/A
612D	Sun Gear, Angled Teeth (28 Splines Inside) (4 Groove).....	1	97-Up	34612B	34971B
612D	Sun Gear, Straight Teeth (32 Splines Inside).....	1	91-96	34612S	34971A
630D	Center Support (No Lube Hole) (Uses 15/16" Long # 783 Bolt)	1	91-96	34630E	34846A
630D	Center Support (No Lube Hole) (Uses a 1 3/8" Long # 783 Bolt)	1	91-96	34630EA	N/A
630D	Center Support (w/ Lube Hole) (no Spacer Type)	1	97-98	34630EB	34846B
630D	Center Support (w/ Lube Hole) (Spacer Type) (Retros 97-Up if used w/ spacer).....	1	99-Up	34630EC	34846C
SPRAGS					
650F	Roller Clutch, Overdrive (.310" OD Rollers, 3 1/4" OD Roller Clutch)	1	91-E01	34650	34925
650F	Roller Clutch, Overdrive (.195" OD Rollers, 3" OD Roller Clutch) (Blue Inserts).....	1	L01-Up	34650A	34925A
652C	Sprag, Intermediate (16 Element)	1	91-Up	34652B	34418
652C	Sprag, Intermediate (34 Element)	1	91-Up	34652A	34418X
652C	Sprag Kit, Intermediate (34 Element) w/Forged Outer Race & High Strength End Bearings ..	1	91-Up	34652AK	K34418X
654D	Roller Clutch, Low (Rear)	1	91-E95	34654	34402A
654D	Roller Clutch, Low (Rear) (has 8 vertical tabs).....	1	L95-Up	34654E	34402B
663C	Race, Intermediate Sprag (Outer) (.795") (Included in 34652AK)	1	91-Up	34663E	34951A
SHAFTS					
670A	Input Shaft	1	91-Up	34670EA	34931A
672I	Mainshaft, 10 3/16" Long (No Lube Hole)	1	91-96	34672A	N/A
672I	Mainshaft, 10 3/16" Long (No Lube Hole)	1	97-Up	34672B	N/A
674D	Shaft, Intermediate Sun Gear (28 Splines on Sun Gear).....	1	91-96	34674A	34970
674D	Shaft, Intermediate Sun Gear (32 Splines on Sun Gear).....	1	97-98	34674B	34970A
674D	Shaft, Intermediate Sun Gear (32 Splines on Sun Gear) (1 Groove on Rear Splines) ...	1	99-Up	34674BA	34970B
678E	Output Shaft, 3 3/4" (4wd) (w/ Lube Hole)	1	91-96	34678N	34980

4L80E

ILL.	DESCRIPTION	QTY.	YEAR	PART NO.	REFERENCE NO.
SHAFTS (Cont.)					
678E	Output Shaft, 5" (4wd) (w/ Lube Hole)	1	91-96	34678P	34980C
678E	Output Shaft, 5" (4wd) (No Lube Hole)	1	97-Up	34678NA	N/A
678E	Output Shaft, 7 3/8" w/ O-Ring Groove (Bolt-On Yoke) (Jaguar) (w/ Lube Hole)	1	91-96	34678T	N/A
678E	Output Shaft, 7 7/8" w/ O-Ring Groove (w/ Lube Hole)	1	91-96	34678S	34980D
678E	Output Shaft, 8 1/8" No O-Ring Groove (w/ Lube Hole) 2wd	1	91-96	34678R	N/A
678E	Output Shaft, 8 1/8" No O-Ring Groove (No Lube Hole) 2wd	1	97-Up	34678RA	N/A
678E	Output Shaft, 8 1/8" w/ O-Ring (w/ Lube Hole) 2wd (Bolt-On Yoke Type)	1	91-96	34678QA	34980B
678E	Output Shaft, 8 1/8" w/ O-Ring (w/ Lube Hole)	1	91-96	34678Q	N/A
678E	Output Shaft, 8 1/8" w/ O-Ring (No Lube Hole) 2wd	1	97-Up	34678QB	N/A
678E	Output Shaft, 9" (Bolt-On Yoke Type) (w/ Lube Hole)	1	91-96	34678M	N/A
678E	Output Shaft, 9" (Brake Drum, & Bolt-On Yoke Type)	1	97-Up	34678MA	N/A
VALVE BODIES					
740J	Valve Body (Premium) (Screw-in Temp Sensor)	1	91-92	34740-3	P34990E
740J	Valve Body (Premium) (Temp Sensor in Wire Harness)	1	92-96	34740-2	P34990G
740J	Valve Body (Premium)	1	97-03	34740-1	P34990J
740J	Valve Body (Premium)	1	04-Up	34740-6	P34990K
VALVE BODY COMPONENTS					
747J	Plate, Valve Body (Universal) (Transgo)	1	91-04	A34747U	34961
741J	Repair Kit, Fixes 5 Valve Body Plate Holes (Most w/ 1/4" Holes)	1	91-Up	VB-101	96-350VB
741J	Valve Kit, TCC Regulator (Uses S34741C-1)	1	91-Up	34741CK	K34969
741J	Seal Kit for S34741CK (Bag of 25)	1	91-Up	34741C-1	N/A
741J	Reverse Boost Valve & Sleeve	1	91-Up	34741ERK	N/A
741J	O-Rings for S34741ERK (Bag of 25)	1	91-Up	ORMK-3	N/A
741J	Valve Kit, Actuator Feed Limit (requires T-77754-TL)	1	91-Up	A34741LK	K34908SV
741J	Repair Kit, Actuator Limit Bore w/ Reamer 5 Oversized Valves and Springs	1	91-Up	A34741LRK	K34908AV
741J	Refill For A34741LRK (Includes 6 Oversize Actuator Valves)	1	91-Up	A34741L	K34908V
741J	Spring, 1-2 Shift Valve	1	91-Up	34741-3	34944
741J	Manual Valve	1	91-Up	34741M-1	N/A
741J	Manual Valve Kit (Upgrade)	1	91-Up	34741MK	K34886
CASES & HOUSINGS					
760E	Case, GM (Gas Exc Jaguar) (w/o Oil Dam at Torque Signal Worm Track)	1	91-E96	34760E	N/A
760E	Case, GM (Diesel & Gas Jaguar) (w/ Oil Dam at Torque Signal Worm Track)	1	91-E96	34760EA	C4L82
760E	Case, GM (Gas Exc Jaguar) (New Lube Circuit Front, Center & Rear)	1	97-Up	34760EB	N/A
760E	Case, GM (HD w/ Structure Mounds at Band Pins)	1	94-Up	34760EC	N/A
760E	Case, GM (HD w/ 4th Pressure Plate Pin)	1	99-04	34760ED	N/A
765E	Pan, 2wd GM (w/out Drain Plug on Side)	1	91-96	34765E	N/A
765E	Pan, 2wd GM (w/ Drain Plug on Side)	1	91-96	34765DP	N/A
765E	Pan, 2wd GM (w/ Drain Plug on Bottom) (Shallow On One End)	1	97-Up	34765EA	N/A
765E	Pan, Jaguar	1	93-96	34765EJ	N/A
765E	Pan, 4wd	1	91-Up	34765G	N/A
770J	Extension Housing, 2 3/4" (4wd)	1	91-Up	34770G	34989A
770J	Extension Housing, 5 3/4" w/ Bearing (2wd)	1	91-Up	34770EB	34989
770J	Extension Housing, 6 5/8" w/ Bearing (2wd)	1	91-Up	34770EA	N/A
SNAP RINGS					
864F	Holds Overrun Pressure Plate In	1	91-Up	34864	N/A
865F	Holds Retainer to Drum	1	91-Up	34865	N/A
872H	Center Support to Case	1	91-Up	34872	N/A
873H	Holds Intermediate Pressure Plate In .092" Thick	1	91-Up	34873	N/A
878C	Holds Forward & Direct Pressure Plate In	1	91-Up	34878	N/A
880F	Holds Turbine Shaft to Overdrive Planet (.040")	1	91-Up	34880	N/A
880F	Holds Turbine Shaft to Overdrive Planet (.080")	1	91-Up	34880A	N/A
883D	Center Support to Case Rear	1	91-Up	34883	N/A
886C	Holds Sprag Retainer to Drum	1	91-Up	34886E	N/A
889I	Holds Rear Ring Gear to Main Shaft	1	91-Up	34889	N/A

4 SPEED w/O.D.

4L80E (MT1) 4L85E (MN8)

ILL.	DESCRIPTION	QTY.	YEAR	PART NO.	REFERENCE NO.
MISCELLANEOUS COMPONENTS					
476I	Silencer Ring, .177" Thick.....	1	91-Up	34476	34999
477I	Reluctor Wheel, Speed Sensor (Presses on Rear Planet).....	1	91-Up	34477A	34999S
483	Cup Plug, Parking Pawl Pin.....	1	91-Up	54483A	13970
496	Kit, Case Cooler Line Conversion.....	1	91-Up	34496K	96-480K
496	Clip, Retaining Clip for 3/8" Push-In Cooler Line to Case Fittings	1	91-Up	74496A	N/A
783	Bolt, Center Support to Case	1	91-Up	34783A	96-328
783	Bolt, 4th Clutch Housing to Case	1	91-Up	34784	96-328B
783	Bolt, 4th Clutch Housing to Case (Hardened)	1	91-Up	34784E	N/A
905E	Servo Assembly, Front	1	91-Up	34905B	N/A
905E	Servo Piston Assembly, Front (2.730" Long Pin) Allows use of early HE band.....	1	91-03	34905BK	DK34986A
905E	Kit, Front Servo Piston & Sleeve	1	91-Up	34905BK	K34986S
906E	Spring, Front Servo	1	91-Up	34906	N/A
907E	Piston, Front Servo (No Tabs on Piston) (Goes w/ 3 Tab 34927)	1	91-Up	34907A	N/A
908E	Pin, Front Servo	1	91-Up	34908B	N/A
910J	Servo Assembly, Rear	1	91-Up	34910	N/A
910J	Servo Assembly, Rear (w/ Raised Hump on Piston)	1	91-Up	34910A	K34956
912J	Piston, Rear Servo	1	91-Up	34912	N/A
913J	Pin, Rear Servo (3.303").....	1	91-Up	34913A	34708G
913J	Pin, Rear Servo (3.415").....	1	91-Up	34913E	N/A
913J	Pin, Rear Servo (3.471").....	1	91-Up	34913H	34708
925	Accumulator Assembly w/ Seals (Upgrade Service Package	1	91-Up	34925K	DK34955
932J	Piston, 3rd Clutch Accumulator	1	91-Up	34932	34985
933	Oversized Accum Pin Kit	1	91-Up	34933X	34707P
933	Oversized Accum Pin & Reamer Kit	1	91-Up	34933XK	T-9147
.	Includes. Reamer, 10 Pins & 20 Retaining Clips				
934	Housing, 2-3 & 3-4 Accumulator	1	91-93	34934E	34992
934	Housing, 2-3 & 3-4 Accumulator	1	94-95	34934EA	34992A
937	Piston, 4th Clutch Accumulator	1	91-Up	34937	DK34987
937	Piston w/ Sleeve, 4th Clutch Accumulator.....	1	91-Up	34937AK	K34987S
938	Pin, 4th Clutch Accumulator	1	91-Up	34938	N/A
941	Spring, Torque Signal Compensator	1	91-Up	34941	N/A
946J	Spring, Rear Servo (Blue).....	1	91-Up	34946	34706
946J	Spring, Rear Servo (Yellow).....	1	91-Up	34946A	N/A
958	Tin Spacer, Front Pump to Sprag (Some Models)	1	91-Up	34958	N/A
960F	Piston, Overrun Clutch (Bonded Rubber)	1	91-Up	34960E	34915
961B	Piston, 4th Clutch.....	1	91-Up	34961	N/A
962H	Piston, Intermediate Clutch.....	1	91-Up	34962	N/A
964G	Piston, Forward Clutch	1	91-96	34964E	N/A
964G	Piston, Forward Clutch (Stamped Steel w/ Bonded Lip Seal)	1	97-Up	34964EA	34917R
965C	Piston, Direct Clutch.....	1	91-96	34965E	34916
965C	Piston, Direct Clutch (w/ Molded Rubber)	1	97-Up	34965G	34916R
970F	Retainer w/ Spring, Overrun Clutch Return.....	1	91-Up	34970	N/A
974G	Spring, Forward Piston Return.....	1	91-Up	34974	N/A
991E	Shaft, Manual Lever	1	91-94	34991E-4	34911S
991E	Shift Shaft.....	1	95-Up	34991F-4	N/A
991E	Linkage Assembly, Internal	1	91-Up	34991E	N/A
994E	Activator Rod (Park Pawl) Updated	1	91-Up	34994E	N/A
995E	Park Pawl Lock, Updated.....	1	91-Up	34995EA-1	N/A
996	Fitting, Cooler Line (5/16" x 1/4").....	2	91-Up	M462C	96-132
996	Connector, Cooler Line to Case.....	1	96-Up	74996B	96-460
996	Fitting, Cooler Line	2	91-95	34996E	N/A
996	Fitting, Cooler Line to Case (Rear) Quick Connect	2	96-Up	34996EA	96-480
996	Fitting, Cooler Line to Case (Rear) Internal Threads	2	96-Up	34996EB	N/A

4L80E

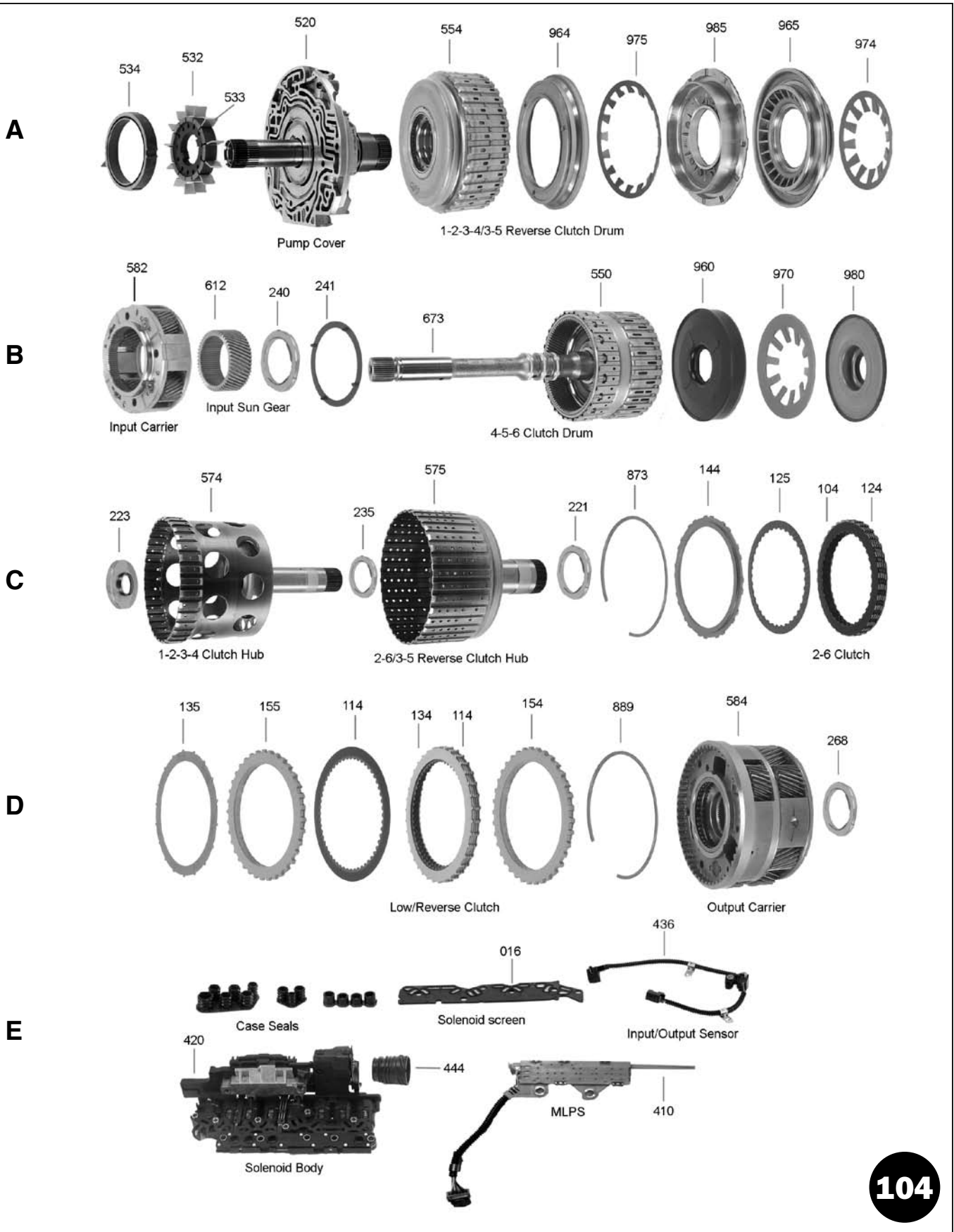

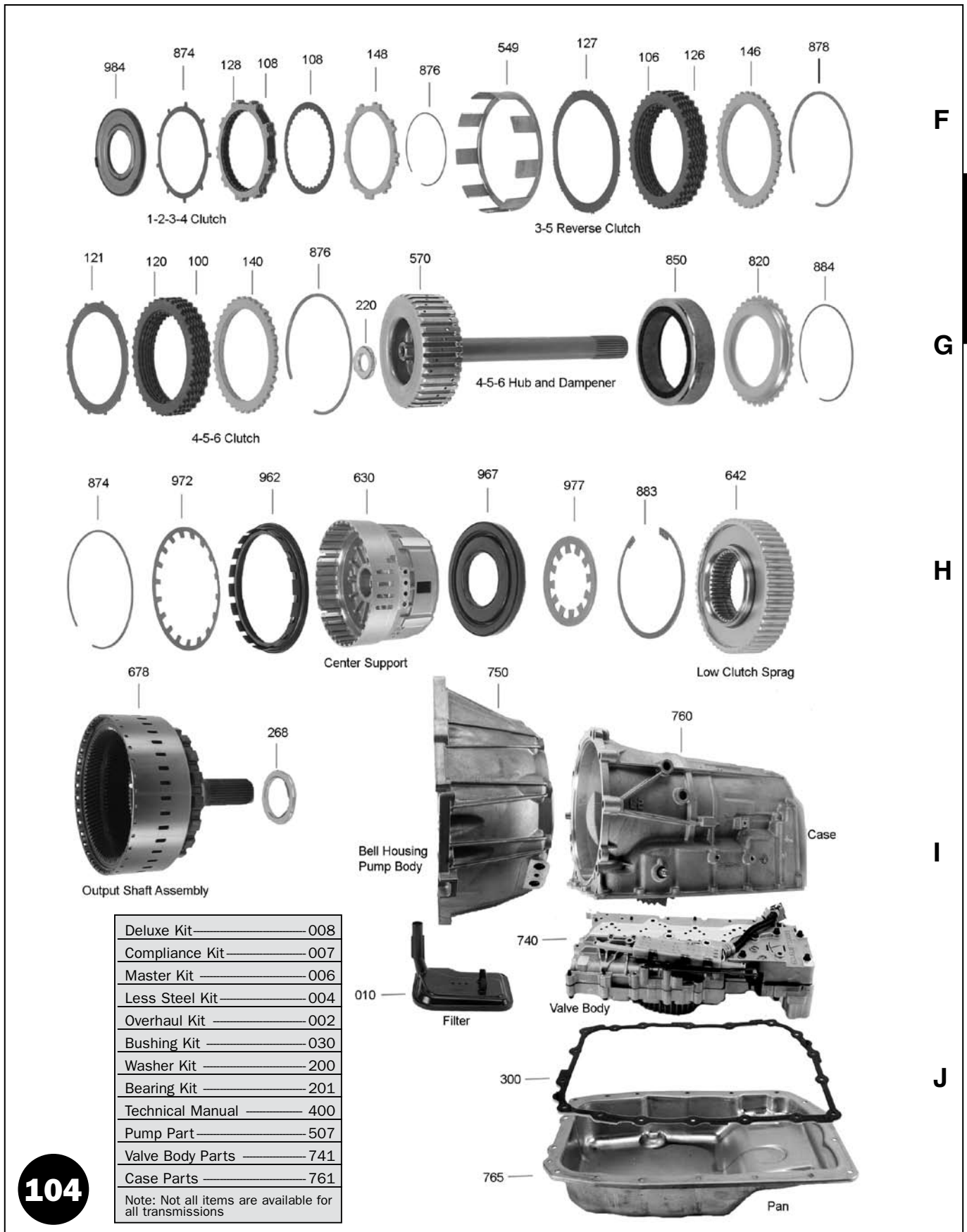

Deluxe Kit	008
Compliance Kit	007
Master Kit	006
Less Steel Kit	004
Overhaul Kit	002
Bushing Kit	030
Washer Kit	200
Bearing Kit	201
Technical Manual	400
Pump Part	507
Valve Body Parts	741
Case Parts	761

Note: Not all items are available for all transmissions

F

G

H

I

J

6L80E

ILL.	DESCRIPTION	QTY.	YEAR	PART NO.	REFERENCE NO.
MASTER OVERHAUL KITS (WITH STEELS)					
006J	6L45, 6L50.....	1	07-Up	104006	N/A
006J	6L80.....	1	06-Up	104006A	N/A
LESS STEEL KITS					
004J	6L45, 6L50.....	1	07-Up	104004	N/A
004J	6L80.....	1	06-Up	104004A	N/A
OVERHAUL KITS (W/ RINGS & SEALS)					
002J	6L45, 6L50.....	1	07-Up	104002	N/A
002J	6L80.....	1	06-Up	104002A	N/A
FILTERS					
010J	6L45, 6L50, 6L80.....	1	06-Up	104010	N/A
016E	Solenoid Screen.....	1	06-Up	104016	N/A
BUSHINGS					
030J	Bushing Kit, 6L45, 6L50.....	1	07-Up	104030	N/A
030J	Bushing Kit, 6L80.....	1	06-Up	104030A	N/A
METAL CLAD SEALS					
070	Front Pump.....	1	06-Up	104074	N/A
072	Linkage.....	1	06-Up	104072	N/A
074	Rear (2wd).....	1	06-Up	104074	N/A
074	Rear (4wd).....	1	06-Up	104074A	N/A
FRICTION PLATES					
100G	Overdrive (4-5-6) (One Sided Internal Teeth) (6L45, 6L50).....	5	07-Up	104100A	N/A
120G	Overdrive (4-5-6) (One Sided External Teeth) (6L45, 6L50).....	5	07-Up	104120A	N/A
100G	Overdrive (4-5-6) (6L80).....	6	06-Up	104100	N/A
104C	Intermediate (2-6) (One Sided Internal Teeth) (6L45, 6L50).....	5	07-Up	104104A	N/A
124C	Intermediate (2-6) (One Sided External Teeth) (6L45, 6L50).....	5	07-Up	104124A	N/A
104C	Intermediate (2-6) (6L80).....	5	06-Up	104104	N/A
106F	Direct (3-5/Reverse) (6L45, 6L50).....	4	07-Up	104106A	N/A
106F	Direct (3-5/Reverse) (6L80).....	4	06-Up	104106	N/A
108F	Forward (1-2, 3-4) (6L45, 6L50).....	5	07-Up	104108A	N/A
108F	Forward (1-2, 3-4) (6L80).....	5	06-Up	104108	N/A
114D	Low/ Reverse (6L45, 6L50).....	6	07-Up	104114A	N/A
114D	Low/ Reverse (6L80).....	5	06-Up	104114	N/A
STEEL PLATES					
120G	Overdrive (4-5-6) (Lindered) (6L80).....	5	06-Up	104120	N/A
121G	Overdrive (4-5-6) (Waved) (6L45, 6L50).....	1	07-Up	104121A	N/A
121G	Overdrive (4-5-6) (Waved) (6L80).....	1	06-Up	104121	N/A
124C	Intermediate (2-6) (6L80).....	5	06-Up	104124	N/A
125C	Intermediate (2-6) (Waved) (6L45, 6L50).....	1	07-Up	104125A	N/A
125C	Intermediate (2-6) (Waved) (6L80).....	1	06-Up	104125	N/A
126F	Direct (3-5/Reverse) (6L45, 6L50).....	4	07-Up	104126A	N/A
126F	Direct (3-5/Reverse) (6L80).....	4	06-Up	104126	N/A
128F	Forward (1-2, 3-4) (6L45, 6L50).....	5	07-Up	104128A	N/A
128F	Forward (1-2, 3-4) (6L80).....	5	06-Up	104128	N/A
129F	Forward (1-2, 3-4) (Waved) (6L45, 6L50).....	1	07-Up	104129A	N/A
129F	Forward (1-2, 3-4) (Waved) (6L80).....	1	06-Up	104129	N/A
134D	Low/ Reverse (6L45, 6L50).....	6	06-Up	104134A	N/A
134D	Low/ Reverse (6L80).....	5	06-Up	104134	N/A

ILL.	DESCRIPTION	QTY.	YEAR	PART NO.	REFERENCE NO.
PRESSURE PLATES					
Prefix Key: D = OEM, A = Aftermarket New, R = Remanufactured					
140G	Overdrive (4-5-6)	1	06-Up	104140	N/A
144C	Intermediate (2-6)	1	06-Up	104144	N/A
146F	Direct (3-5/Reverse).....	1	06-Up	104146	N/A
148F	Forward (1-2-3-4).....	1	06-Up	104148	N/A
154D	Low/ Reverse.....	1	06-Up	104154	N/A
SEALING RING KITS					
175J	Sealing Ring Kit, 6L45, 6L50	1	07-Up	104175	N/A
175J	Sealing Ring Kit, 6L80.....	1	06-Up	104175A	N/A
THRUST WASHER KITS					
200J	Thrust Washer Kit, 6L45, 6L50.....	1	07-Up	104200	N/A
200J	Thrust Washer Kit, 6L80.....	1	06-Up	104200A	N/A
BEARING KITS					
201J	Bearing Kit, 6L45, 6L50	1	07-Up	104201	N/A
201J	Bearing Kit, 6L80	1	06-Up	104201A	N/A
GASKETS & O-RINGS					
300J	Pan Gasket (6L45, 6L50)	1	07-Up	104300	N/A
300J	Pan Gasket (6L80)	1	06-Up	104300A	N/A
TECHNICAL MANUALS					
400J	6L45, 6L50.....	1	07-Up	104400	N/A
400J	6L80.....	1	06-Up	104400A	N/A
400J	Transmission Guide (6 Speed).....	1	06-Up	104400B	N/A
ELECTRICAL COMPONENTS					
410E	Sensor, MLPS (6L45, 6L50)	1	07-Up	104410	N/A
410E	Sensor, MLPS (6L80).....	1	06-Up	104410A	N/A
420E	Solenoid Assembly (6L45, 6L50)	1	07-Up	104420	N/A
420E	Solenoid Assembly (6L80)	1	06-Up	104420A	N/A
444E	Connector (6L45, 6L50).....	1	07-Up	104444	N/A
444E	Connector (6L80)	1	06-Up	104444A	N/A
HARD PARTS					
Prefix Key: D = OEM, A = Aftermarket New, R = Remanufactured					
PUMPS					
750I	Pump Body w/ Rotor (Bell Housing) (6L45, 6L50)	1	07-Up	104510	N/A
750I	Pump Body w/ Rotor (Bell Housing) (2wd Exc Corvette) (6L80).....	1	06-Up	104510A	N/A
750I	Pump Body w/ Rotor (Bell Housing) (2wd Corvette) (6L80)	1	06-Up	104510B	N/A
520A	Pump Cover (Stator) (6L45, 6L50)	1	07-Up	104520	N/A
520A	Pump Cover (Stator) (6L80)	1	06-Up	104520A	N/A
PUMP COMPONENTS					
532A	Rotor (13 Vane, 18mm)	1	06-Up	104532	N/A
533A	Vanes	13	06-Up	104533	N/A
534A	Slide (18mm).....	13	06-Up	104534	N/A
538	Rings.....	2	06-Up	104538	N/A
539	Guide.....	1	06-Up	104539	N/A

ILL.	DESCRIPTION	QTY.	YEAR	PART NO.	REFERENCE NO.
DRUMS & CLUTCH HUBS					
550C	Overdrive w/ Shaft (4-5-6) (0.905" Front Stator Bushing) (6L45, 6L50)	1	07-Up	104550	N/A
550C	Overdrive w/ Shaft (4-5-6) (1.115" Front Stator Bushing) (6L80)	1	06-Up	104550A	N/A
554A	Forward & Direct (1-2-3-4 & 3-5/Rev) (6L45, 6L50)	1	07-Up	104554	N/A
554A	Forward & Direct (1-2-3-4 & 3-5/Rev) (6L80)	1	06-Up	104554A	N/A
570G	Hub, Overdrive w/ Shaft (6L45, 6L50)	1	07-Up	104570	N/A
570G	Hub, Overdrive w/ Shaft (6L80)	1	06-Up	104570A	N/A
574C	Hub Forward w/ Shaft (6L45, 6L50)	1	07-Up	104574	N/A
574C	Hub Forward w/ Shaft (6L80)	1	06-Up	104574A	N/A
575C	Hub, Direct & Intermediate (6L45, 6L50)	1	07-Up	104575	N/A
575C	Hub, Direct & Intermediate (6L80)	1	06-Up	104575A	N/A
PLANETS					
582B	Front (20 T Pinion Gears) (6L45, 6L50)	1	07-Up	104582	N/A
582B	Front (22 T Pinion Gears) (6L80)	1	06-Up	104582A	N/A
584D	Rear (Output) (6L45, 6L50)	1	07-Up	104584	N/A
584D	Rear (Output) (6L80)	1	06-Up	104584A	N/A
SUN GEARS					
612B	Sun Gear, Forward (49 T) (6L45, 6L50)	1	07-Up	104612	N/A
612B	Sun Gear, Forward (50 T) (6L80)	1	06-Up	104612A	N/A
614	Sun Gear, Rear (Output) (Front) (6L45, 6L50)	1	07-Up	104614	N/A
614	Sun Gear, Rear (Output) (Front) (6L80)	1	06-Up	104614A	N/A
615	Sun Gear, Rear (Output) (Rear) (6L45, 6L50)	1	07-Up	104615	N/A
615	Sun Gear, Rear (Output) (Rear) (6L80)	1	06-Up	104615A	N/A
CENTER SUPPORTS					
630H	Center Support (6L45, 6L50)	1	07-Up	104630	N/A
630H	Center Support (6L80)	1	06-Up	104630A	N/A
SPRAGS					
642H	Sprag Assembly, Low/ Reverse (6L45, 6L50)	1	07-Up	104642	N/A
642H	Sprag Assembly, Low/ Reverse (6L80)	1	06-Up	104642A	N/A
SHAFTS					
673B	Turbine Shaft (included w/ Overdrive Drum)	1	06-Up	N/A	N/A
678I	Output Shaft (6L45, 6L50)	1	07-Up	104678	N/A
678I	Output Shaft (6L80) (2wd)	1	06-Up	104678A	N/A
678	Output Shaft (6L80) (4wd)	1	06-Up	104678AA	N/A
VALVE BODIES					
740J	Valve Body (6L45, 6L50)	1	07-Up	104740	N/A
CASES & HOUSINGS					
750I	Pump Body w/ Rotor (Bell Housing) (6L45, 6L50)	1	07-Up	104510	N/A
750I	Pump Body w/ Rotor (Bell Housing) (6L80) (2wd Exc Corvette)	1	06-Up	104510A	N/A
750I	Pump Body w/ Rotor (Bell Housing) (6L80) (2wd Corvette)	1	06-Up	104510B	N/A
760I	Case (6L45, 6L50)	1	07-Up	104760	N/A
760I	Case (6L80) (2wd)	1	06-Up	104760A	N/A
765I	Pan (6L45, 6L50)	1	07-Up	104765	N/A
765I	Pan (6L80)	1	06-Up	104765A	N/A
770	Extension Housing (6L45, 6L50)	1	07-Up	104770	N/A
770	Extension Housing (6L80) (2wd)	1	06-Up	104770A	N/A
770	Extension Housing (6L80) (4wd)	1	06-Up	104770B	N/A

4T40E(MN4), 4T45E(MN5) - 4 SPEED TURBO HYDRAMATIC

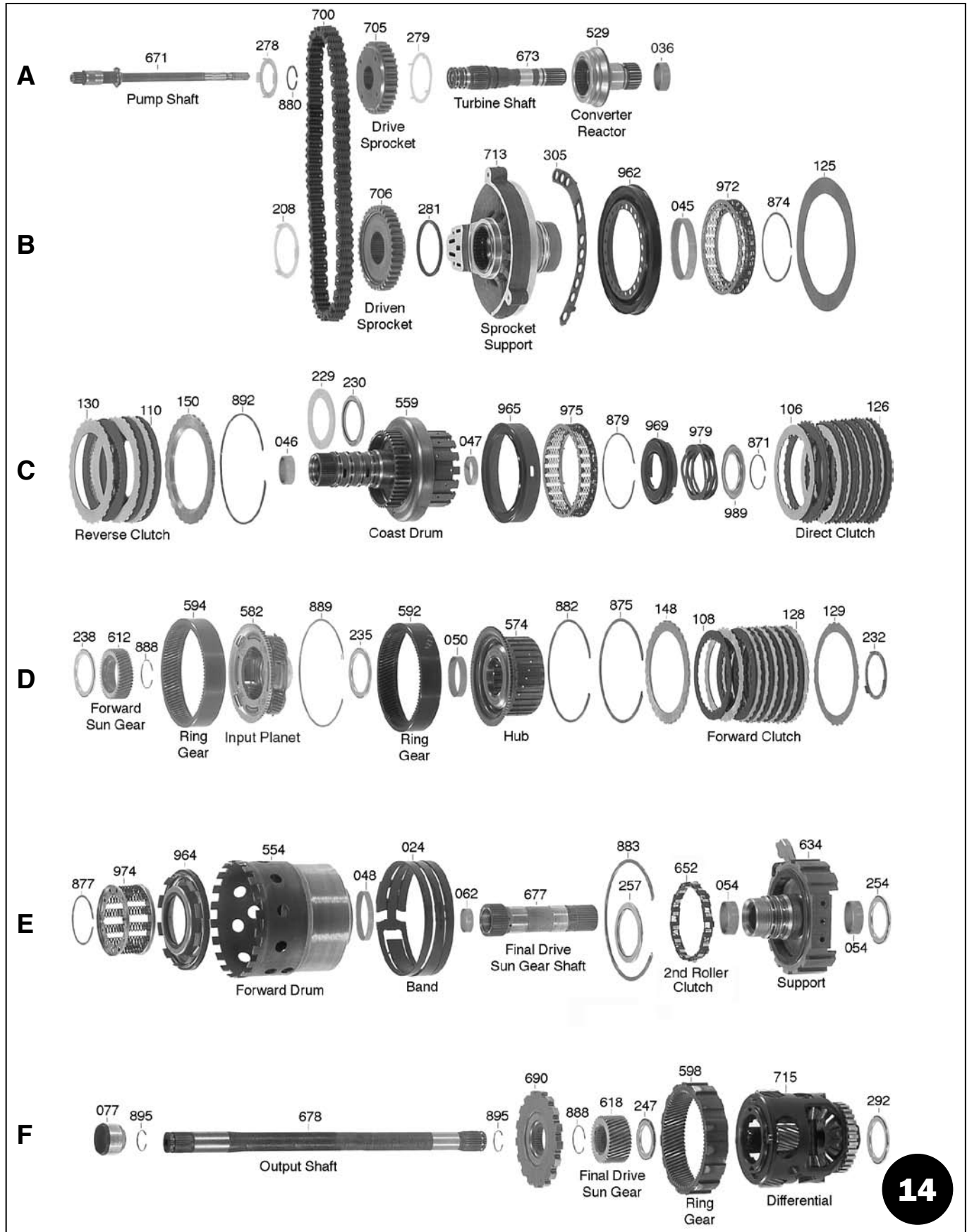

4T40E(MN4), 4T45E(MN5) - 4 SPEED TURBO HYDRAMATIC

4T40E

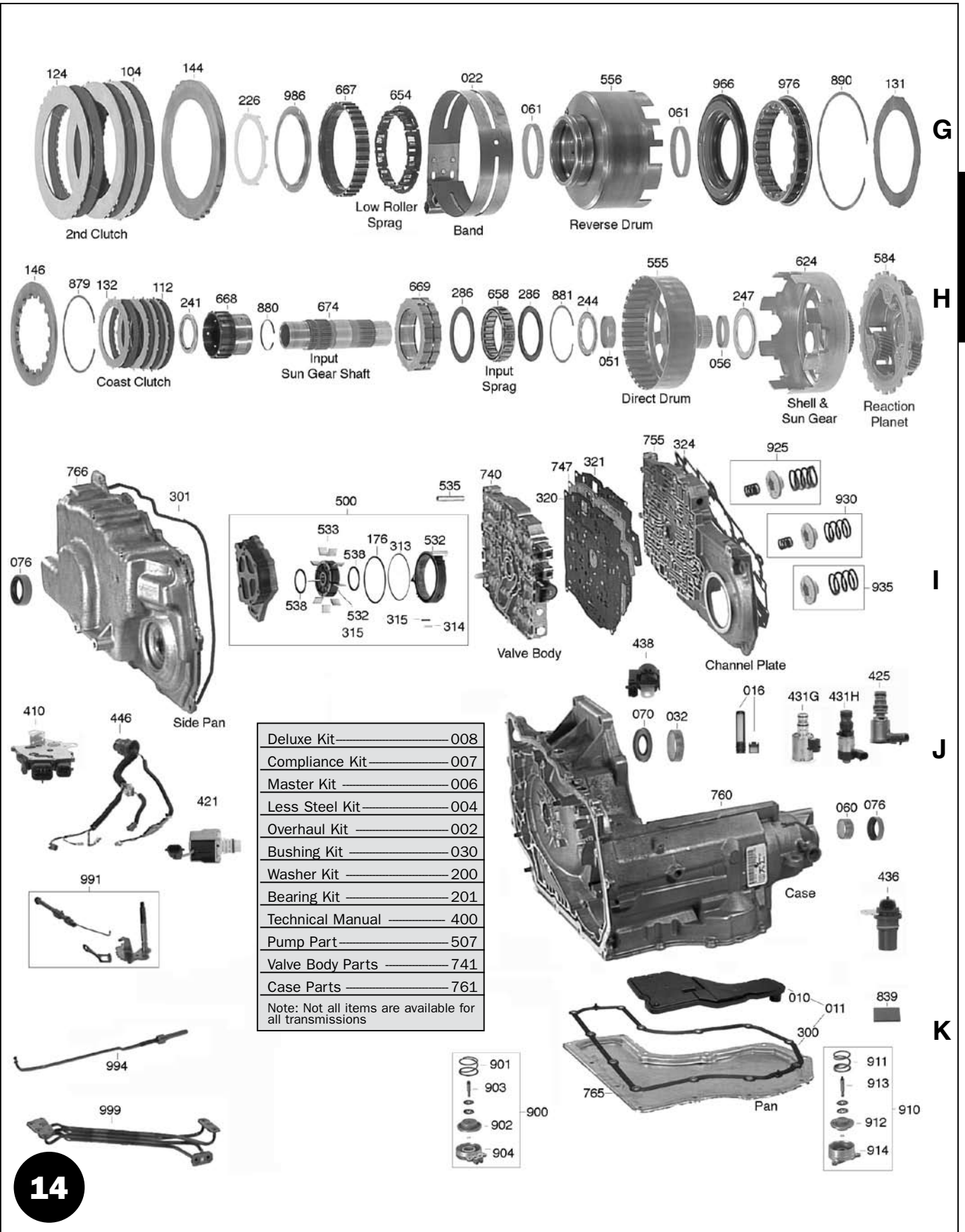

Deluxe Kit	008
Compliance Kit	007
Master Kit	006
Less Steel Kit	004
Overhaul Kit	002
Bushing Kit	030
Washer Kit	200
Bearing Kit	201
Technical Manual	400
Pump Part	507
Valve Body Parts	741
Case Parts	761

Note: Not all items are available for all transmissions

4T40E(MN4), 4T45E(MN5) - 4 SPEED TURBO HYDRAMATIC

ILL.	DESCRIPTION	QTY.	YEAR	PART NO.	REFERENCE NO.
DELUXE KITS (SUPER KITS)					
008J	4T40E, 4T45E (w/ Bonded Pistons).....	1	95-Up	14008APW	K8600-R
COMPLIANCE KITS (CALIFORNIA KITS)					
007J	4T40E, 4T45E (w/ Bonded Pistons).....	1	95-Up	14007APW	CK8600-R
MASTER OVERHAUL KITS (WITH STEELS)					
006J	4T40E, 4T45E (w/ Bonded Pistons).....	1	95-Up	14006APW	K8600
LESS STEEL KITS					
004J	4T40E, 4T45E (w/ Bonded Pistons).....	1	95-Up	14004APW	K8600-LS
OVERHAUL KITS (W/ RINGS & SEALS)					
002J	4T40E, 4T45E (w/o Bonded Pistons).....	1	95-Up	14002AW	K86900
002J	4T40E, 4T45E (w/ Bonded Pistons).....	1	95-Up	14002APW	K86900M
FILTER KITS					
011K	Filter Kit	1	95-Up	14011AW	FK86710
FILTERS					
010K	Filter	1	95-Up	14010A	86710
016J	Screen, Shift Solenoid (Snaps in Separator Plate)	1	95-Up	74016A	61713A
016J	Screen, Actuator Feed (in Valve Body)	1	95-Up	14016	86712
BANDS					
Prefix Key: B = Borg Warner, A = OEM (Exc BW), N = All Other New, R = Relined					
022G	Intermediate (2-4) Flex	1	95-Up	14022A	86700
022G	Low/ Reverse.....	1	95-Up	84022E	66700E
BUSHINGS					
030J	Bushing Kit	1	95-Up	14030A	K86901
032J	Converter Hub.....	1	95-Up	64032B	51005A
036A	Converter Reactor	1	95-Up	54036A	32006
045B	Driven Support.....	1	95-Up	14045A	86002
047C	Input Shaft (Rear).....	1	95-Up	14047A	86005
048E	Forward Drum (Front)	1	95-Up	14048A	86009
048E	Forward Drum (Rear)	1	95-Up	14048B	86010
050D	Forward Clutch Hub	1	95-Up	14050A	86008
051H	Reaction Carrier Shell (Front).....	1	95-Up	14051A	86007
054E	Final Drive Support.....	1	95-Up	14054A	86012
056H	Reaction Carrier Shell (Rear)	1	95-Up	14056A	86006
060J	Case	1	95-Up	64060	51013
061G	Reverse Drum (Front).....	1	95-Up	14061A	86003
061G	Reverse Drum (Rear)	1	95-Up	14061B	86004
062E	Final Drive Shaft.....	1	95-Up	14062A	86011
METAL CLAD SEALS					
070J	Converter.....	1	95-Up	84070	51200AV
072	Manual Lever	1	95-Up	84072A	51202A
076J	Axle (Both Sides, Outer)	2	95-Up	14076A	86201
077F	Axle Sleeve (Both Sides, Inner).....	2	95-Up	14077A	86205
FRICTION PLATES					
104G	2nd Clutch	3	95-Up	14104A	86100

4T40E(MN4), 4T45E(MN5) - 4 SPEED TURBO HYDRAMATIC

ILL.	DESCRIPTION	QTY.	YEAR	PART NO.	REFERENCE NO.
FRICITION PLATES (Cont.)					
104G	2nd Clutch (High Performance) (Blue)	3	95-Up	R14104AHP	86100X
106C	Direct (External Teeth)	4-6	95-Up	14106A	86104
106C	Direct (External Teeth) (High Performance) (Blue)	4-6	95-Up	R14106AHP	86104X
108D	Forward	7	95-Up	14108A	86106
108D	Forward (High Performance) (Blue)	7	95-Up	R14108AHP	86106X
110C	Reverse	3	95-Up	14110A	86102
110C	Reverse (High Performance) (Blue)	3	95-Up	R14110AHP	86102X
112H	Coast	4	95-Up	14112A	86108
112H	Coast (High Performance) (Blue)	4	95-Up	R14112AHP	86108X
STEEL PLATES					
124G	2nd Clutch .089" (8 T)	3	95-Up	14124A	86101
125B	2nd Clutch .070" (No T) Waved	1	95-Up	14125A	86111
126C	Direct .074" (16 T) Internal Teeth	4-6	95-Up	14126A	86105
128D	Forward .069" (30 T)	7	95-Up	14128A	86107
129D	Forward .039" (30 T) Waved	1	95-Up	14129A	86112
130C	Reverse .088" (30 T)	3	95-97	14130A	86103
130C	Reverse .085" (30 T) (w/ 4 Turbulator Holes)	3	98-Up	14130B	86103A
131G	Reverse .043" (30 T) Waved	1	95-Up	14131A	86110
132H	Coast .069" (12 T)	4	95-Up	14132A	86109
PRESSURE PLATES					
Prefix Key: D = OEM, A = Aftermarket New, R = Remanufactured					
144G	Intermediate (2nd Design)	1	95-Up	14144A	86713
146H	Direct Backing	1	95-Up	14146	86715
148D	Forward Backing (.197") (Flat)	1	95-Up	14148	86716
150C	Reverse Backing (.126")	1	95-Up	14150A	86714A
150C	Reverse Backing (.177")	1	95-Up	14150B	86714B
150C	Reverse Backing (.222")	1	95-Up	14150C	86714C
SEALING RINGS					
175J	Ring Kit	1	95-Up	14175A	K86300
177	Direct	4	95-Up	14177AT	86322T
178	Turbine Shaft (Rear) (Small OD - Green)	2	95-96	64178BT	51307T
178	Turbine Shaft (Rear) (Large OD - White)	2	97-Up	14178AT	86307T
178	Turbine Shaft (Front)	1	95-Up	64178AT	51310T
179	Driven Sprocket Support	2	95-Up	14179AT	86320T
181	Forward	2	95-Up	14181AT	86321T
N.I.	Pump Slide	1	95-Up	64176T	
THRUST WASHERS & BEARINGS					
200J	Washer Kit	1	95-Up	14200A	K86400
209	Bearing, Pump Shaft	1	95-Up	14209	67922B
281B	Washer, Case Cover To Driven Sprocket	1	95-Up	14281A	N/A
241H	Washer, Driven Sprocket to Rev Input (8 Tabs)	1	95-Up	14226A	N/A
235D	Washer, Forward Clutch Hub	1	95-Up	14235A	N/A
GASKETS & O-RINGS					
300K	Gasket, Bottom Pan (Bonded)	1	95-Up	14300AW	13998R
301I	Gasket, Side Cover (Inner)	1	95-Up	14301A	13994R
301I	Gasket, Side Cover (Outer)	1	95-Up	14301	13999R
320I	Gasket, Separator Plate to Case	1	95-03	14320	13968
320I	Gasket, Separator Plate to Case (White Stripe)	1	04-Up	14320A	N/A
321I	Gasket, Separator Plate to VB	1	95-03	14321	13967
321I	Gasket, Separator Plate to VB (White Stripe)	1	04-Up	14321A	N/A

4T40E

4T40E(MN4), 4T45E(MN5) - 4 SPEED TURBO HYDRAMATIC

ILL.	DESCRIPTION	QTY.	YEAR	PART NO.	REFERENCE NO.
GASKETS & O-RINGS (Cont.)					
324I	Gasket, Case Cover	1	95-Up	14324	13922
379	Seal, Sump Filter to Case	1	95-Up	14379	13988
378	Seal, Cooler Line to Case	1	95-Up	14378	N/A
TECHNICAL MANUALS					
400J	Tech Manual, 4T40E,4T45E.....	1	95-Up	14400A	86Y01
400J	Transmission Guide (GM).....	1	95-Up	14400B	N/A
ELECTRICAL COMPONENTS					
410J	MLPS w/ Wire Harness	1	1995	14446B	15D-178
410J	MLPS w/o Wire Harness	1	1996	14410B	15D-178A
410J	MLPS w/o Wire Harness (2 Connectors, 7 & 4 Pins)	1	97-Up	14410	15D-178B
410J	MLPS w/o Wire Harness (1 Connector, 11 Pins)	1	04-Up	14410A	15D-178C
411	Switch, Pressure Manifold (Gray)	1	95-03	14411A	15D-176
411	Switch, Pressure Manifold (Black)	1	04-Up	14411B	15D-176B
421J	Solenoid, 1-2, 3-4 Shift (A & B)	2	95-Up	14421A	5D-188
425J	Solenoid, Lock-Up (TCC) (replaces 84425A)	1	95-Up	74418E	5A-187
431J	Solenoid, Pressure Control (EPC)	1	95-02	84431G	5A-186
431J	Solenoid, Pressure Control (EPC)	1	03-Up	84431H	5D-186B
436J	Sensor, Output Speed (VSS) (Exc 95-Up Sunfire).....	1	95-Up	14436A	20D-134
436J	Sensor, Output Speed (VSS) (95-Up Sunfire)	1	95-Up	14436B	N/A
438J	Sensor, Turbine/ Input (TSS) 4 Cyl (32 or 33 T)	1	95-Up	14438	20D-132A
438J	Sensor, Turbine/ Input (TSS) 6 Cyl (35 T)	1	97-Up	14438A	20D-132B
446J	Wire Harness, Internal (14 Prong Gray Round Connector).....	1	95-Up	14446	35D-163
446J	Wire Harness, Internal (13 Prong Black Round Connector) (Malibu, Maxx & G6)	1	04-Up	14446A	N/A
N.I.	Tool, Wire Harness Removal Tool (Teckpak).....	1	95-Up	T-TGM-HR	T-9138
HARD PARTS					
Prefix Key: D = OEM, A = Aftermarket New, R = Remanufactured					
PUMPS					
500I	Pump.....	1	95-Up	14500	86990
529A	Converter Reactor (Stator Support Shaft)	1	95-Up	14529	86985
507J	Repair Kit, Pressure Reg. Valve.....	1	95-Up	14507K	K86864
507J	Repair Kit, Pressure Reg. Valve (Refills).....	1	95-Up	14507RK	K86864V
DRUMS					
554E	Forward	1	95-Up	14554	86964
556G	Reverse	1	95-Up	14556	86926
559C	Input w/ Step (Direct, Coast Clutch & Input Shaft).....	1	95-Up	14559	86999
559C	Input w/o Step (Direct, Coast Clutch & Input Shaft).....	1	95-Up	14559B	86999B
PLANETS					
582D	Input (4 Gear)	1	95-Up	14582	86851
584H	Reaction (3 Gear).....	1	95-Up	14584	N/A
583	Gear Train (Input Planet, Reaction Planet & Sun Gear)	1	95-Up	14583A	K86950
592D	Ring Gear, Input & Reaction Planet	1	95-Up	14592	N/A
598F	Ring Gear, Final Drive 78 T Right Angle 15 Lugs	1	95-Up	14598	N/A
SUN GEARS, SHELLS & SUPPORTS					
612D	Sun Gear, Rear Input	1	95-Up	14612	N/A
624H	Shell, Direct Clutch Housing/ Reaction.....	1	95-Up	14624	N/A
634E	Support, Rear w/ Parking Pawl (16 Rollers)	1	95-98	14634	86965
634E	Support, Rear w/ Parking Pawl (17 Rollers)	1	99-05	14634B	86965B
634E	Support, Rear w/ Parking Pawl (21 Rollers)	1	06-Up	14634C	86965C

4T40E(MN4), 4T45E(MN5) - 4 SPEED TURBO HYDRAMATIC

ILL.	DESCRIPTION	QTY.	YEAR	PART NO.	REFERENCE NO.
SPRAGS					
652E	Roller, 2nd Clutch (12 Element)	1	95-Up	14652A	86930
654G	Roller Clutch, Low (16 Element)	1	95-97	14654A	86960
654G	Roller Clutch, Low (17 Rollers)	1	98-E06	14654B	86960A
654G	Roller Clutch, Low (21 Rollers)	1	L06-Up	14654C	86960C
N.I.	Roller Clutch & Support Assembly, Low (21 Rollers)	1	L06-Up	14644C	K86965C
658H	Sprag, Forward	1	95-Up	14658A	86940
658H	Sprag Assembly w/ Input Sun Gear Shaft # 14674, Forward	1	95-Up	14658AK	K86940
669H	Cam, Intermediate One Way (Outer)	1	95-Up	14669	N/A
SHAFTS					
671A	Shaft, Pump Drive	1	95-Up	14671	86981
673A	Shaft, Turbine 6" Long	1	95-Up	14673	N/A
674H	Shaft, Input Sun Gear (incl in 14658AK)	1	95-Up	14674	K86940
677E	Shaft, Final Drive Sun Gear (w/ Hub)	1	95-Up	14677	86996
678F	Shaft, Output (Right Side Stub) 3.625" Long	1	95-Up	14678	N/A
678F	Shaft, Output (Left Side 18-1/4" Long)	1	95-Up	14678A	86906
690F	Gear, Parking 17 Lugs	1	95-Up	14690	N/A
CHAINS, SPROCKETS & SUPPORTS					
700A	Chain, 5/8" Wide (42 Links) (Rocker Joint) 4T40E	1	11/03-Up	14700C	86973C
700A	Chain, 3/4" Wide (Rocker Joint Type)	1	95-Up	14700A	86973
700A	Chain, 7/8" Wide (42 Links) (Rigid Chain)	1	97-Up	14700B	86973B
705A	Sprocket, Drive 32 T (3.600" OD)	1	95-Up	14705	N/A
706B	Sprocket, Driven 38 T (4.276" OD) (1.225" Height)	1	95-Up	14706	N/A
713B	Support, Driven Sprocket	1	95-Up	14713	86949
713B	Support, Driven Sprocket (w/ Check Ball Capsule)	1	95-Up	14713A	86949B
N.I.	Sprocket Assembly (32 T / 38 T) 3/4" Chain	1	95-Up	14705K	86977A
N.I.	Sprocket Assembly (35 T / 35 T) 3/4" Chain	1	95-Up	14705AK	86977
N.I.	Sprocket Assembly (32 T / 38 T) 7/8" Chain	1	95-Up	14705CK	86977C
N.I.	Sprocket Assembly (35 T / 35 T) 7/8" Chain	1	95-Up	14705BK	86977B
DIFFERENTIALS					
715F	34 T Sun Gear, 22 T Pinion (3.29 Ratio) (Reluctor Wheel Not Included)	1	95-Up	14715	K86972
715F	38 T Sun Gear, 20 T Pinion (3.05 Ratio) (Reluctor Wheel Not Included)	1	95-Up	14715A	K86972A
715F	42 T Sun Gear, 18 T Pinion (2.86 Ratio) (Reluctor Wheel Not Included)	1	95-Up	14715B	K83972B
598F	Ring Gear, Final Drive 78 T Right Angle 15 Lugs	1	95-Up	14598	N/A
677E	Shaft, Final Drive Sun Gear	1	95-Up	14677	86996
VALVE BODIES					
740I	Valve Body (Premium) (w/ Holley) (Vented PR Valve)	1	95-01	14740-1	P86991
740I	Valve Body (Premium) (w/ Holley) (Solid PR Valve)	1	02-03	14740-2	P86991B
740I	Valve Body (Premium) (w/ Bosch)	1	04-Up	14740-4	P86991D
VALVE BODY COMPONENTS					
741J	Boost Valve & Sleeve	1	95-Up	14741F	K86971
741J	Sleeve, TCC Control Valve (requires T-F-33000-TL)	1	95-Up	14741C-2	86883
741J	Sleeve, TCC Regulator Apply Valve (PWM) (requires T-33000-TL)	1	95-Up	14741Q-2	86881
741J	Sleeve Kit, AFL Valve (requires T-33886-TL)	1	95-Up	14741LK	86885
741J	Valve, Pressure Regulator (Oversized) (requires T-33886-TL2)	1	95-Up	14741P-1	86887

4T40E

Raise Profit, Lower Expenses & Increase Business With...

GUARANTEED Remanufactured Valve Bodies by **VBXTM**

STOP!

*Don't waste excess \$\$
on "Dealer New"*

*Don't Chance a CB
with "Good Used"*

Consider These Benefits...

** Individually Tested & 100% GUARANTEED **

** Sonnax Updates & Exclusive VB-XtraTM Updates **

** 12 Month Unlimited Mileage Warranty **

** Fully Staffed Product Support Department **

\$ Financial Example \$

Typical cost for your shop to rebuild an early 4T65E:

Parts (new pressure manifold switch, new solenoids & Sonnax Updates) =	\$ 236.68
Tools (includes two reamers and one drill) =	\$ 184.21
Technician Labor Cost (approximately two hours) =	\$ 60.00
TOTAL COST FOR YOUR SHOP TO REBUILD AN EARLY 4T65E =	\$ 480.89

*In this example alone, purchasing a GUARANTEED Remanufactured Valve Body by **VBXTM** would have cost you about \$200.00 LESS and saved you time, thereby allowing you to rebuild more transmissions and increase business!*



www.valvebodyxpress.com

SonnaxTM
TASC Force
Member

"We build them so you don't have to..."

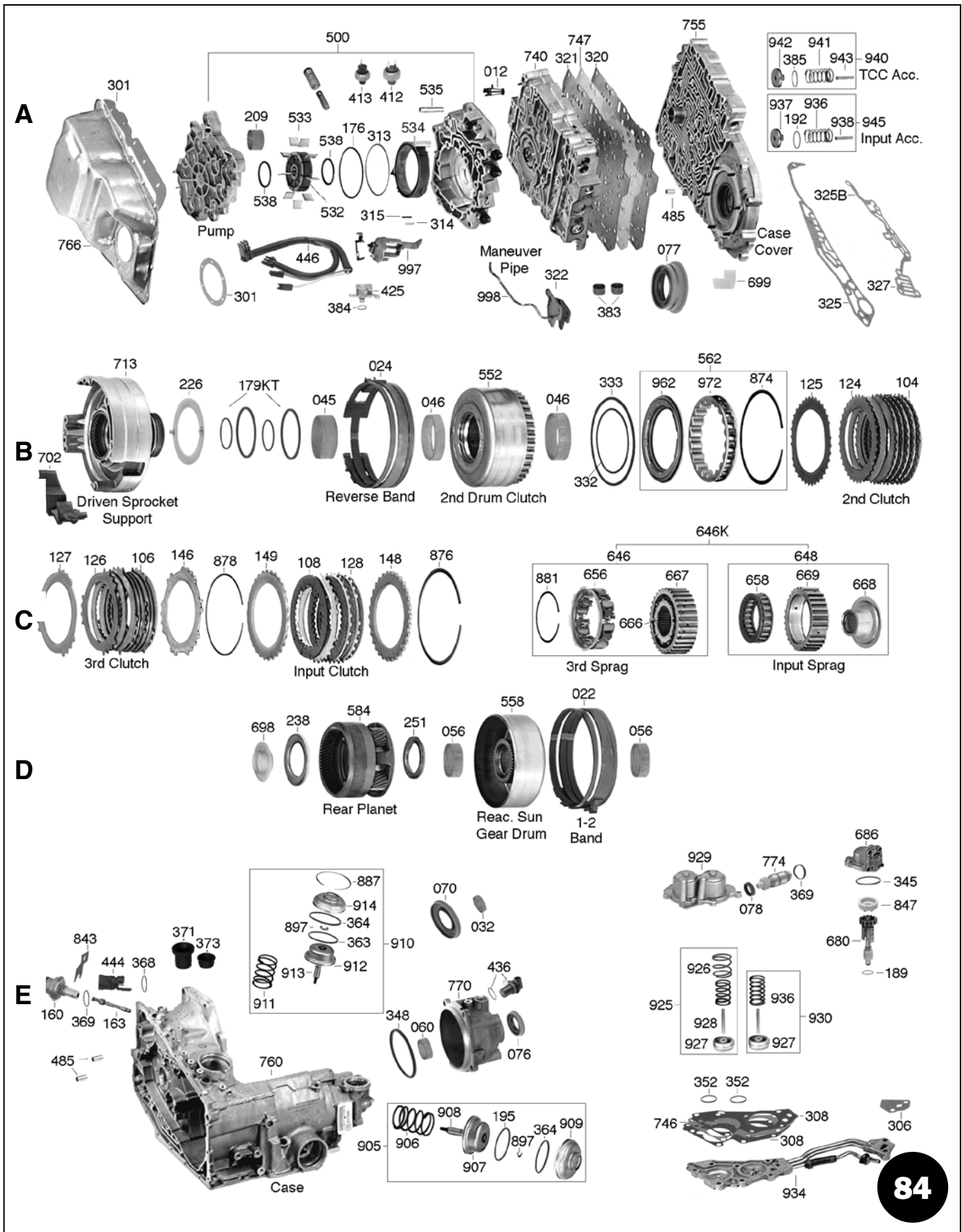

F

935
939 385 938 936B
3-4 Acc.

671
Pump Shaft

380 278 880

700

705 279

178 178 380
Turbine Shaft

295 529 036
Converter Reactor

G

120 100 140
4th Clutch

217 220

570
4th Clutch Hub

280

706 281
Driven Sprocket

Chain

560

862 971 961 331 298
330

H

144 873 229 230 177 048
Input/Forward Drum

554

335 232 233 334

964 974 985 877 337 965 975 879
564 336

I

619 612
Sun Gear

624

241 678
Output Shaft

895 237 582
053
Front Planet

Reverse Reaction Shell

J

674 257 889 054 598 254 690 618
Final Drive Sun Gear Shaft
Final Drive Ring Gear
Park Gear
Final Drive Sun Gear

715 204 247 638 204 293 292

K

Deluxe Kit	008
Compliance Kit	007
Master Kit	006
Less Steel Kit	004
Overhaul Kit	002
Bushing Kit	030
Washer Kit	200
Bearing Kit	201
Technical Manual	400
Pump Part	507
Valve Body Parts	741
Case Parts	761

Note: Not all items are available for all transmissions

84

379 010-011 300 765

383 839 383B 383A 999 072 992

991

440-T4, 4T60

TH440-T4(ME9), 4T60

4 SPEED - FWD



84010
84300

440 CASE

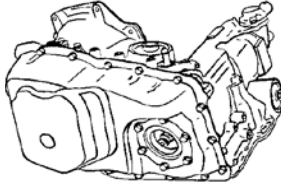

BUICK CenturyA ElectraC LeSabreH Park Avenue.....C Park Avenue.....Ultra ReattaZ RegalG RivieraE Skylark.....N SomersetN	CADILLAC Allente Brougham.....C DeVilleC Eldorado.....E FleetwoodC Seville.....K	OLDSMOBILE Ciera.....A Cutlass CruiserA Cutlass Supreme Delta 88H 98 RegencyC RoyaleH Silhouette.....U ToronadoE Trofeo
CHEVROLET BerettaA CelebrityA CorsicaA Lumina Z-34	PONTIAC 6000.....A BonnevilleH Grand Prix.....G&W Transport.....U	

ILL.	DESCRIPTION	QTY.	YEAR	PART NO.	REFERENCE NO.
DELUXE KITS (SUPER KITS) (1)					
008K	440-T4.....	1	84-E86	84008	K6600A-R
008K	440-T4 Exc 87-93 Allante (2)	1	L86-88	84008A	K6600B-R
008K	440-T4 Exc 87-93 Allante (2)	1	89-93	84008B	K6600C-R
COMPLIANCE KITS (CALIFORNIA KITS) (1)					
007K	440-T4.....	1	84-E86	84007	CK6600A-R
007K	440-T4 Exc 87-93 Allante (2)	1	L86-88	84007A	CK6600B-R
007K	440-T4 Exc 87-93 Allante (2)	1	89-93	84007B	CK6600C-R
MASTER OVERHAUL KITS (WITH STEELS) (1)					
006K	440-T4.....	1	84-E86	84006	K6600A
006K	440-T4 Exc 87-93 Allante (2)	1	L86-88	84006A	K6600B
006K	440-T4 Exc 87-93 Allante (2)	1	89-93	84006B	K6600C
LESS STEEL KITS (1)					
004K	440-T4.....	1	84-E86	84004	K6600A-LS
004K	440-T4 Exc 87-93 Allante (2)	1	L86-88	84004A	K6600B-LS
004K	440-T4 Exc 87-93 Allante (2)	1	89-93	84004B	K6600C-LS
OVERHAUL KITS (W/ RINGS & SEALS) (1)					
002K	440-T4 Exc 87-93 Allante (2)	1	84-93	84002	K66900B
GASKET & SEAL KITS (W/O RINGS & SEALS) (1)					
000K	440-T4 Exc 87-93 Allante (2)	1	84-93	84000	K66900-1
FILTER KITS (1)					
011K	Filter Kit, 440-T4	1	84-93	84011	FK66710
	(1) - To order Kits with Fiber pan gaskets, use an "F" suffix. (2) - 87-93 Allante, sell kit plus sub kit # 84001				
FILTERS					
010K	Filter	1	84-93	84010	66710
012A	Screen, Oil Pump (w/ Tab).....	1	84-93	84012	66712
012A	Screen, Oil Pump (No Tab)	1	84-93	84012A	66712A
014	Screen, Governor (Inside # 934)	1	84-88	84014	N/A
014	Screen, Governor (Inside # 934)	1	89-93	84014A	51711
015	Screen, 3rd Clutch Exhaust	1	84-93	84015	66711
016	Screen, TCC Solenoid	1	84-E95	84016P	66714A
016	Screen, TCC Solenoid Orifice.....	1	L85-93	84016PA	66714

4 SPEED - FWD

TH440-T4(ME9), 4T60

ILL.	DESCRIPTION	QTY.	YEAR	PART NO.	REFERENCE NO.
BANDS					
Prefix Key: B = Borg Warner, A = OEM (Exc BW), N = All Other New, R = Relined					
022D	1-2 (Rear).....	1	84-93	84022A	66700
024B	Reverse (Front).....	1	84-93	84024	66720
BUSHINGS					
030K	Bushing Kit.....	1	84-93	84030	K66901
032E	Converter Hub.....	1	84-93	64032B	51005A
036F	Stator Support Front.....	1	84-93	54036A	32006
045B	Driven Sprocket Support.....	1	84-93	84045	66010
046B	2nd Clutch Housing (Rear).....	1	84-93	84046	66012
046B	2nd Clutch Housing (Front).....	1	84-93	84046B	66011
048H	Input Drum (w/ 4 Oil Grooves).....	1	84-93	84048A	66013
053I	Front Planet.....	1	86-93	84053	66015
054J	Final Drive Internal Gear Shaft.....	2	84-93	84054	66017
056D	Rear Sun Gear (Front) (1-2 Band Drum).....	1	84-93	84056	66016
060E	Case.....	2-3	84-93	64060	51013
METAL CLAD SEALS					
070E	Front.....	1	84-93	84070	51200AV
072K	Manual Lever (.350" Thick).....	1	84-93	84072A	51202A
076E	Axle (Right Side Only).....	1	84-93	84076	51201
077A	Axle (Left Side Only).....	1	84-93	84077	66220A
075	Axle Stabilizer (Teckpak).....	1	84-93	T84075	51731BS
078E	Speed-O Seal w/ Spring.....	1	84-93	44078A	3991L
078E	Speed-O Seal w/o Spring.....	1	84-93	44078X	3991LS
090	Channel Plate Repair Plate, Elim. Oil Leakage.....	1	84-93	84090	66996P
FRICTION PLATES					
100G	4th Clutch (.090").....	1	84-90	84100	66104
100G	4th Clutch (.070").....	2	91-93	84100A	66104A
104B	2nd Clutch.....	5-6	84-93	84104A	66102A
106C	3rd Clutch (2 Sided) (Use w/ 84126 Steels).....	4	84-86	84106	66103
106C	3rd Clutch (.084") (1 Sided, 32 Internal T).....	4	84-88	84106A	66103A
106C	3rd Clutch (.082") (1 Sided, 32 Internal T).....	5	89-93	84106B	66103C
106C	3rd Clutch (.084") (1 Sided, 12 External T).....	4	84-88	84126AA	66103B
106C	3rd Clutch (.078") (1 Sided, 12 External T).....	5	89-93	84126AB	66103D
108C	Input Clutch.....	4	84-93	84108	66106
STEEL PLATES					
120G	4th Clutch.....	2	84-93	84120	66204
124B	2nd Clutch (.090").....	3	84-86	84124	66202
124B	2nd Clutch (.090") (Kolene).....	5	84-86	84124C	66202A
124B	2nd Clutch (.077").....	6	87-93	84124A	66202E
124B	2nd Clutch (.077") (Kolene).....	6	87-93	84124D	66202D
125B	2nd Clutch (.044") (Waved).....	1	84-93	84125	66202B
126C	3rd Clutch (Flat).....	1-4	84-87	84126	66203
127C	3rd Clutch (Waved).....	1	88-93	84127	66203B
128C	Input Clutch (.076").....	3-4	84-E90	64128	51100
128C	Input Clutch (.050").....	4	L90-93	84128	66100
129	Input Clutch (.040") (Waved).....	1	L90-93	64129	51105
FRICTION & STEEL KITS					
N.I.	Friction & Steel Kit, 4th Clutch .090" (Bent Tooth) (1 Fri & 2 Steels).....	1	84-90	A84100APK	66104X
N.I.	Friction & Steel Kit, 4th Clutch .070" (Bent Tooth) (2 Fri & 2 Steels).....	1	91-93	A84100BPK	K66104BX

440-T4, 4T60

ILL.	DESCRIPTION	QTY.	YEAR	PART NO.	REFERENCE NO.
FRICION & STEEL KITS (Cont.)					
N.I.	Friction & Steel Kit, 4th Clutch .070" (Bent Tooth) (2 Fri, 2 Thick & 1 Thin Steel)	1	1993	A84100BAPK	K66104CX
N.I.	Friction & Steel Kit, 2nd Clutch .060" (Power Pack) (7 Fri, 6 Thin & 1 Thick Steel)	1	84-93	A84104CPK	N/A
N.I.	Steel Module.....	1	89-93	84139B	N/A
PRESSURE PLATES					
Prefix Key: D = OEM, A = Aftermarket New, R = Remanufactured					
140G	4th Clutch	1	84-86	84140	66210
140G	4th Clutch	1	87-93	84140A	66210J
144H	2nd Clutch (.155") (Flat)	1	84-86	84144A	66210A
144H	2nd Clutch (.125") (Beveled)	1	86-93	84144C	66210D
144H	2nd Clutch (.390") (Beveled)	1	90-93	84144D	66210K
146C	3rd Clutch	1	84-93	84146A	66210H
148C	Input Clutch Backing (Top)	1	84-93	84148	51714
149C	Input Clutch Apply (Bottom)	1	84-93	84149	66206
MODULATORS					
160E	Black & Red Stripe (Single Line) Diesel	1	84-93	84160B	66820Y
160E	Red Stripe (Dual Line) (GM Universal)	1	84-93	84160R	66820X
163E	Valve, Under Modulator (1st Design, Long)	1	84-E86	84163	66821
163E	Valve, Under Modulator (2nd Design, Short)	1	L86-93	84163A	66821A
N.I.	Modulator Kit (w/ Large Can Modulator, Valve, & Gaskets)	1	84-93	84160K	DK66820B
VALVE BODY RECALIBRATION KITS					
165K	Shift Kit®, Tri-Pack (Fixes 3 Transmissions) (Transgo®)	1	84-93	T84165-3	K66908
165K	Reverse Cushion Kit, Corrects Harsh Reverse (Transgo®)	1	84-93	T84165A	K66908R
165K	Lube & End Play Kit (Transgo®)	1	84-93	T84165LE	K66908L
165K	Shift Kit-Jr®, 440-T4 Junior (Transgo®)	1	84-93	T84167	K66908J
165K	Valve Body Kit (Superior).....	1	84-93	S84165	66C01
SEALING RINGS					
175K	Ring Kit (2nd Clutch Metal Rings)	1	84-86	84175	N/A
175K	Ring Kit (2nd Clutch Vespel Rings)	1	87-93	84175A	K66300AT
175K	Ring Kit (2 Vespel Rings & 2 Rubber Expanders)	1	87-93	84179KT	N/A
THRUST WASHERS					
200K	Washer Kit (No Selectives)	1	84-93	84200	K66400
200K	Washer Kit (w/ Popular Selectives)	1	84-93	84200B	N/A
226B	Driven Sprocket Support to 2nd Clutch Drum	1	84-93	84226	66412
230H	Input Drum 2.90-3.00mm (Orange-Green)	1	84-93	84230	66415A
230H	Input Drum 3.05-3.15mm (Orange-Black)	1	84-93	84230A	66415B
230H	Input Drum 3.20-3.30mm (Orange)	1	84-93	84230B	66415C
230H	Input Drum 3.35-3.45mm (White)	1	84-93	84230C	66415D
230H	Input Drum 3.50-3.60mm (Blue)	1	84-93	84230D	66415E
230H	Input Drum 3.65-3.75mm (Pink)	1	84-93	84230E	66415F
230H	Input Drum 3.80-3.90mm (Brown)	1	84-93	84230EA	66415G
230H	Input Drum 3.95-4.05mm (Green)	1	84-93	84230G	66415H
230H	Input Drum 4.10-4.20mm (Black)	1	84-93	84230H	66415J
230H	Input Drum 4.25-4.35mm (Purple)	1	84-93	84230HA	66415K
230H	Input Drum 4.40-4.50mm (Purple-White)	1	84-93	84230J	66415L
230H	Input Drum 4.55-4.65mm (Purple-Blue)	1	84-93	84230JA	N/A
230H	Input Drum 4.70-4.80mm (Purple-Pink)	1	84-93	84230L	N/A
230H	Input Drum 4.85-4.95mm (Purple-Brown)	1	84-93	84230M	N/A
230H	Input Drum 5.00-5.10mm (Purple-Green)	1	84-93	84230N	N/A
232H	Input Drum Rear (4 Tang).....	1	84-93	84232	66413
278F	Drive Sprocket to Channel Plate.....	1	84-93	84278	66411

ILL.	DESCRIPTION	QTY.	YEAR	PART NO.	REFERENCE NO.
THRUST WASHERS (Cont.)					
279F	Drive Sprocket to Support	1	84-93	64279A	51413
280G	4th Clutch Hub to Driven Sprocket.....	1	84-93	84280	66414
281G	Driven Sprocket to Support (4 Legs)	1	84-93	84281	66410
N.I.	Repair Kit, Final Drive Planet (16 Steel Washers) (.850" OD, .440" ID)	1	84-93	84204B	N/A
N.I.	Repair Kit, Final Drive Planet (8 Brass & 8 Steel Washers).....	1	84-93	64204D	K51440A
BEARINGS					
201K	Bearing Kit	1	84-93	84201A	K66500
209	Pump Shaft.....	1	84-93	84209	66520
217G	4th Clutch Hub to Channel Plate	1	84-93	84217	66508
220G	4th Clutch Hub	1	84-93	84220A	66952
229H	2nd Clutch Drum to Input Drum.....	1	84-93	84229	66504
232H	Input Drum Rear.....	1	84-93	84232A	66413A
238D	Front Planet to Rear Planet	1	84-93	84238	66502
241I	Sun Gear (Split, Inner) (1-3/4" Long).....	1	84-90	84241	66521
241I	Sun Gear (Split, Inner) (3/4" Long).....	1	91-93	84241A	66521A
247J	Sun Gear to Differential Carrier (2.00" OD) 2.84 Ratio	1	84-93	54247A	32409A
247J	Sun Gear to Differential Carrier (2.125" OD) 3.06 Ratio	1	84-93	84247	51454
251D	Rear Planet to Sun Gear Drum.....	1	84-93	84251	66501
254J	Park Gear to Ring Gear	1	84-93	84254	66506
257J	Reaction Drum to Internal Ring Gear.....	1	84-93	84257	66509
275	Axle Stabilizer, Passenger Side (w/ Bearing & Seal) (Teckpak)	1	84-93	T64275	51731B
275	Axle Stabilizer, Driver Side (w/ Bearing & Seal) (Teckpak)	1	84-93	T84275	66731B
292J	Differential to Case.....	1	84-93	64292	51461
295F	Needle Converter Reactor (Presses Inside)	1	84-93	64295	51486
298G	Needle Driven Sprocket Support (Presses Inside)	1	84-93	84298	6695
230H	Shim, Input Clutch Hub .010" (10 Shims).....	1	84-93	84230S	66415S
230H	Shim, Input Clutch Hub .020" (10 Shims).....	1	84-93	84230SA	66415T
233H	Sleeve, Input Drum Rear (4 Notches).....	1	84-93	84741C-2	66932
293J	Spacer, Differential to Case 1.65mm (#2)	1	84-93	64293B	51417A
293J	Spacer, Differential to Case 1.75mm (#3)	1	84-93	64293C	51417B
293J	Spacer, Differential to Case 1.85mm (#4)	1	84-93	64293D	51417C
293J	Spacer, Differential to Case 1.95mm (#5)	1	84-93	64293E	51417D
293J	Spacer, Differential to Case 2.05mm (#6)	1	84-93	64293F	51417E
293J	Spacer, Differential to Case 2.15mm (#7)	1	84-93	64293G	51417F
293J	Spacer, Differential to Case 2.25mm (#8)	1	84-93	64293H	51417H
293J	Spacer, Differential to Case 2.35mm (#9)	1	84-93	64293J	51417J
293J	Shim, Differential Carrier to Case	1	84-93	84293S	51417S
N.I.	Repair Kit, Final Drive Planet (16 Steel Washers).....	1	84-93	84204A	K66400B
N.I.	Repair Kit, Final Drive Planet (8 Brass & 8 Steel Washers).....	1	84-93	64204D	K51440A
GASKETS & O-RINGS					
300K	Gasket, Bottom Pan (Cork)	1	84-93	84300	13966X
300K	Gasket, Bottom Pan (Fiber).....	1	84-93	84300F	13966F
301A	Gasket, Side Cover (Outer) (Cork)	1	84-93	84301	13450
301A	Gasket, Side Cover (Outer) (Fiber)	1	84-93	84301F	13450F
301A	Gasket, Side Case Cover (Inner) (Cork)	1	84-93	84301J	13451
301A	Gasket, Side Case Cover (Inner) (Fiber)	1	84-93	84301JF	13451F
306E	Gasket, Governor Control Body	1	84-93	84306	13798
308E	Gasket, Accumulator Cover	2	84-93	84308	13452
313A	O-Ring, Pump Slide Back-Up.....	1	84-93	84313	13982A
314A	Seal, Pump Slide (Rubber)	1	84-93	54314B	13768
315A	Seal, Pump Slide (Teflon)	1	84-93	54315B	13762
320A	Gasket, Valve Body Spacer Plate to Channel Plate	1	E1985	84320A	N/A
320A	Gasket, Valve Body Spacer Plate to Channel Plate	1	L85-93	84320AA	13788

440-T4, 4T60

ILL.	DESCRIPTION	QTY.	YEAR	PART NO.	REFERENCE NO.
GASKETS & O-RINGS (Cont.)					
320A	Gasket, Valve Body Spacer Plate to Channel Plate (Allante) (Incl in # 84001).....	1	89-93	84320L	N/A
321A	Gasket, Valve Body to Spacer Plate.....	1	E1985	84321A	N/A
321A	Gasket, Valve Body to Spacer Plate.....	1	L85-93	84321AA	13787
325A	Gasket, Lower Channel Plate.....	1	84-93	84325	13805
325A	Gasket, Upper Channel Plate.....	1	84-E85	84325B	13806
325A	Gasket, Upper Channel Plate (One Piece Design).....	1	L85-93	84325E	13806A
327A	Gasket, Modulator Port.....	1	84-93	84327	13807
334H	Lip Seal, Input Clutch Piston (Inner).....	1	84-93	84334	N/A
335H	Lip Seal, Input Clutch Piston (Outer).....	1	84-93	84335	N/A
336H	Lip Seal, 3rd Clutch Piston (Inner).....	1	84-93	84336	13791
337H	Lip Seal, 3rd Clutch Piston (Outer).....	1	84-93	84337	N/A
352E	Lathe Cut Seal, 1-2 & 3-4 Accumulator Piston.....	2	84-93	54352A	13965
364E	O-Ring, 1-2 & Reverse Servo Cover.....	2	84-93	84364	13803
371E	Boot, Filler Tube.....	1	84-93	44371B	13925
373E	Boot, Detent Cable.....	1	84-93	54373B	13581
376	O-Ring, Converter Clutch Solenoid Screen.....	1	84-93	84376	13795
379K	Seal, Filter Seal.....	1	84-93	84379	13987
383A	Cup Seal, Servo Pipe to Valve Body.....	2	84-93	84383	66222
TECHNICAL MANUALS					
400K	Tech Manual, 440-T4.....	1	84-93	84400	66Y01
400K	Tech Manual, 440-T4 Update Volume 1 1986.....	1	86-93	84400H1	66Y02
400K	Tech Manual, 440-T4 Update Volume 2 1990.....	1	90-93	84400H2	66Y04
400K	Transmission Guide (GM).....	1	84-93	84400EA	N/A
ELECTRICAL COMPONENTS					
412A	Switch, 3rd Clutch Pressure (2 Prong).....	1	84-93	84412A	15D-132
413A	Switch, 4th Clutch Pressure (1 Prong).....	1	84-93	84413	15D-131
425A	Solenoid (TCC) (Universal).....	1	84-93	84425	5R-148
437	Switch, Thermister 1 Prong.....	1	84-93	84437A	N/A
437	Switch, Thermister 2 Prong.....	1	84-93	84437	N/A
444E	Connector, Case (Square 4 Prong).....	1	84-93	84444	25A-104
444E	Connector, Case (Round 4 Prong Natural).....	1	84-93	64444	25D-105
444E	Connector, Case (Round 5 Prong Black).....	1	84-93	64444A	25D-108
444E	Connector, Case (Universal, Replaces 2, 3, 4 Prong Square).....	1	84-93	84444U	N/A
HARD PARTS					
Prefix Key: D = OEM, A = Aftermarket New, R = Remanufactured					
PUMPS					
500A	Pump (2 Pressure Switches, No 3-2 Tube Hole).....	1	84-E85	84500	66990
500A	Pump (2 Pressure Switches, No 3-2 Tube Hole).....	1	L85-86	84500AB	66990A
500A	Pump (2 Pressure Switches, w/ 3-2 Tube Hole) (Exc Cadillac w/ Viscous Conv.).....	1	87-93	84500C	N/A
500A	Pump (3 Pressure Switches, No 3-2 Tube Hole).....	1	84-87	84500AA	66900A
500A	Pump (3 Pressure Switches, w/ 3-2 Tube Hole).....	1	88-93	84500DA	66990B
520A	Pump Cover, 14 Bolt.....	1	84-93	84520A	66992A
PUMP COMPONENTS					
507K	Pump Cover Sleeve.....	1	84-93	64541	N/A
529F	Converter Reactor (Stator Support).....	1	84-93	64529A	66985
532A	Rotor, Pump 17.968mm.....	1	84-93	84532AB	66802
533A	Vane, Pump 17.952mm.....	9	84-93	84533AA	66800
533A	Vane Kit, Pump 17.952mm (9 Rings).....	1	84-93	84533AAK-1	K66800
533A	Vane & Ring Kit, Pump 17.952mm.....	1	84-93	84533AAK	N/A
533A	Vane & Ring Kit, Pump 17.970mm.....	1	84-93	84533ABK	K66800B
534A	Slide, Pump 17.968mm.....	1	84-93	84534AB	66803

4 SPEED - FWD

TH440-T4(ME9), 4T60

ILL.	DESCRIPTION	QTY.	YEAR	PART NO.	REFERENCE NO.
PUMP COMPONENTS (Cont.)					
535A	Pin, Pivot Slide (No Groove)	1	84-93	84535	66805
535A	Pin, Pivot Slide (Groove)	1	1993	84535A	66805A
538A	Ring, Pump Vane	2	84-93	84538	66324
DRUMS & CLUTCH HUBS					
552B	2nd Clutch (5 Clutch) (6 Lube Holes In Bore).....	1	84-86	84552A	66926
552B	2nd Clutch (6 Clutch) (6 Lube Holes In Bore).....	1	87-93	84552B	66926A
554H	Forward, w/ Input Shaft (Washer Type).....	1	84-87	84554A	66999
554H	Forward, w/ Input Shaft (Bearing Type).....	1	88-93	84554B	66999A
558D	Reaction w/ Sun Gear.....	1	84-93	84558	66960
570G	4th Clutch Hub & Shaft (Bearing & Sleeve)	1	84-93	84570A	66956
PLANETS					
582I	Front (.350" Wide Bushing)	1	84-85	84582	66905
582I	Front (.265" Wide Bushing)	1	86-93	84582A	66905A
584D	Rear	1	84-93	84584	66955A
598J	Ring Gear, Final Drive	1	84-89	84598	66935
598J	Ring Gear, Final Drive	1	90-93	84598A	66935A
SUN GEARS, SHELLS & SUPPORTS					
612I	Sun Gear, Input (Front)	1	84-93	84612	66904
618J	Sun Gear, Final Drive 30 T	1	84-93	84618B	51955BN
618J	Sun Gear, Final Drive 34 T	1	84-93	84618A	51955A
618J	Sun Gear, Final Drive 38 T	1	84-93	84618	51955
619I	Spacer, Input Sun Gear (.338").....	1	85-93	84619B	66945A
619I	Spacer, Input Sun Gear (.350").....	1	85-93	84619A	66945
624I	Shell, Reverse Reaction (Hardened).....	1	84-93	84624	66978A
SPRAGS					
656C	Sprag, 3rd Clutch	1	84-93	84656	66939
658C	Sprag, Low Input.....	1	84-E86	84658	66933
658C	Sprag, Low Input.....	1	L86-93	84658A	66933A
646C	Sprag Assembly, 3rd/ Low Input.....	1	84-86	84646	K66939
646C	Sprag Assembly, 3rd/ Low Input (84-Up if used w/ 84554B & 84232A)	1	87-93	84646A	K66939A
648C	Sprag, 3rd/ Low Input (84-Up if used w/ 84989A & 84619A).....	1	L86-93	84648A	K66940
SHAFTS					
671F	Pump Shaft, Oil Pump Drive (9 3/4" Long)	1	84-93	84671	66981
673F	Turbine Shaft.....	1	84-93	84673	66930
674J	Final Drive Sun Gear Shaft (No Lube Dam).....	1	84-E85	84674	66943
674J	Final Drive Sun Gear Shaft (w/ Lube Dam)	1	L85-93	84674A	66943A
678I	Output Shaft (Bearing Type).....	1	84-E85	84678A	66906
678I	Output Shaft (Bearing Type) (19 11/16").....	1	L85-93	84678BA	66906A
GOVERNORS					
680E	Governor (w/ 14 T on Electric Pick-Up Gear)	1	84-93	84680C	N/A
680E	Governor (w/ 15 T on Electric Pick-Up Gear)	1	84-93	84680D	66912E
683	Gear, Governor Drive (Or Speed-0).....	1	84-93	64683A	N/A
690J	Gear, Parking.....	1	84-93	84690	66986
698D	Oil Dam, Front Planet.....	1	84-93	84698	66910
699A	Weir, Oil Reservoir.....	1	84-93	84699	N/A
CHAINS					
700F	Chain (Exc Allante).....	1	84-93	84700A	51973A
702B	Scoop, Chain Scavenging (For 35 T Sprocket)	1	L85-93	84702C	N/A

440-T4, 4T60

ILL.	DESCRIPTION	QTY.	YEAR	PART NO.	REFERENCE NO.
SPROCKETS & SUPPORTS					
705F	Sprocket Set, w/ Shaft (35 Drive & 35 Driven) (Round Pin)	1	84-93	84710AK	K66977
705F	Sprocket Set, w/ Shaft (37 Drive & 33 Driven) (Round Pin)	1	84-93	84710CK	K66977A
713B	Support, Driven Sprocket 2nd Design (Scoupe Type)	1	86-93	84713A	66949A
DIFFERENTIALS					
715J	30 T Sun Gear, 20 T Pinion (.760" OD Cross Pin) 3.33 Ratio.....	1	84-88	84715CA	51972D
715J	30 T Sun Gear, 20 T Pinion (.705" OD Cross Pin) 3.33 Ratio (2.945" Journal).....	1	88-93	84715CG	66972K
715J	30 T Sun Gear, 20 T Pinion (.705" OD Cross Pin) 3.33 Ratio (3.035" Journal).....	1	88-93	64715D	66972F
715J	34 T Sun Gear, 18 T Pinion (.760" OD Cross Pin) 3.06 Ratio.....	1	84-88	84715CB	51972B
715J	34 T Sun Gear, 18 T Pinion (.705" OD Cross Pin) 3.06 Ratio (2.945" Journal).....	1	88-93	84715BB	66972J
715J	34 T Sun Gear, 18 T Pinion (.705" OD Cross Pin) 3.06 Ratio (3.035" Journal).....	1	88-93	64715C	66972G
715J	38 T Sun Gear, 16 T Pinion (.760" OD Cross Pin) 2.84 Ratio.....	1	84-88	84715AB	51972C
715J	38 T Sun Gear, 16 T Pinion (.760" OD Cross Pin) 2.84 Ratio (2.945" Journal).....	1	88-93	84715AC	66972H
715J	38 T Sun Gear, 16 T Pinion (.760" OD Cross Pin) 2.84 Ratio (3.035" Journal).....	1	88-93	64715	66972E
598J	Ring Gear, Final Drive	1	84-89	84598	66935
598J	Ring Gear, Final Drive	1	90-93	84598A	66935A
674J	Final Drive Sun Gear Shaft (No Lube Dam).....	1	84-E85	84674	66943
674J	Final Drive Sun Gear Shaft (w/ Lube Dam)	1	L85-93	84674A	66943A
717	Washer, Differential Side Gear	1	84-93	84717-1	66418A
VALVE BODIES					
740A	Valve Body (Small Check Balls Only)	1	84-E85	84740	66991
740A	Valve Body (Large & Small Check Balls)	1	L85-93	84740A	66991A
VALVE BODY COMPONENTS					
741K	Anti Shudder Spring	1	84-93	A84741C-3	66975
741K	Boost Valve Kit, Modulated Line High Ratio	1	84-93	84741MA-1	K66822D
741K	Boost Valve Kit, Modulated Line Low Ratio	1	84-93	84741M-1	K66822C
741K	Boost Valve Kit, Reverse & Modulated Line	1	84-93	84741MAK	K66822H
741K	Boost Valve Kit, Reverse & Modulated Line Low Ratio.....	1	84-93	84741MK	K66822L
741K	Boost Valve Kit, Reverse High Ratio	1	84-93	84741RAK-1	K66822K
741K	Boost Valve Kit, Reverse Low Ratio	1	84-93	84741RK-1	K66822J
741K	Bushing, T.V. Plunger (.625" Stamped L)	1	84-93	84741NB-7	K66971L
741K	Bushing, T.V. Plunger (.745" Stamped H).....	1	84-93	84741ND-7	K66971H
741K	Bushing, T.V. Plunger (.775" Stamped P)	1	84-93	84741NE-7	K66971P
741K	Check Balls (Steel)	1	84-93	44741-5	13924S
741K	Repair Kit, Valve Body Plate w/ 1/4" Check Balls.....	1	84-93	VB-101	96-350VB
741K	E-Ring Retainer, Boost Sleeve (Bag of 10)	1	84-93	84741-4G	66836
741K	Kit, 1-2 & Reverse Servo Boost Valve (requires T-84754-TL4)	1	84-93	84741GK	K66828
741K	Lock-Up Sleeve, Input & 3rd Clutch	1	84-93	84741C-2	66932
741K	Retainer, Boost Sleeve (Bag of 10)	1	84-93	84741-4B	66837
741K	Retainer Pin, Servo Boost Sleeve (Bag of 10)	1	84-93	84741-4A	66838
741K	Spring Kit, Converter Clutch	1	84-93	84741C-3K	K66975
741K	Spring, TCC Valve	1	84-93	84741C-3	66975
741K	T.V. Plunger (.357" Steel)	1	84-93	84741N-4	66971A
741K	T.V. Plunger (.396" Steel)	1	84-93	84741NA-4	66971
741K	Valve Body Clip (Bag of 10).....	1	84-93	84741-4F	66835
741K	Valve, 3-2 Downshift (Inside Valve Body).....	1	84-93	84741S-1	66826V
741K	Valve, 1-2 Shift	1	84-93	84741SD-1	66823V
741K	Valve, TCC Apply Standard	1	84-93	84741C-1	66972AV
741K	Valve, TCC Apply Oversized (requires T-84754-TL5)	1	84-93	84741CA-1	66972V
MISCELLANEOUS COMPONENTS					
480	Capsule, w/ Check Ball, Drum/Stator .260" Diameter (Copper)	1	84-93	54480C	N/A
480	Capsule w/ Spring & Check Valve, Under Servo Tube	1	84-93	84480T	66987
755A	Channel Plate (Cast # 208) (No Switch)	1	88-93	84755E	66995B

ILL.	DESCRIPTION	QTY.	YEAR	PART NO.	REF NO.
MISCELLANEOUS COMPONENTS (Cont.)					
N.I.	Sleeve, Channel Plate (Presses In Channel Plate)	1	84-93	84755S	66641
N.I.	Retainer, 3-2 Line Control Valve (In Channel Plate)	1	84-93	84755V-4	66965
765K	Pan, Bottom	1	84-93	84765	N/A
275	Axle Stabilizer, Passenger Side (Bearing Type w/ Seal) (Teckpak)	1	84-93	T64275	51731B
275	Axle Stabilizer, Driver Side (Bearing Type w/ Seal) (Teckpak)	1	84-93	T84275	66731B
921	Band Stop, 1-2 Band (Plastic)	1	84-93	84921	66725
888	Snap Ring, Holds Pinion Pins In Differential Housing	1	84-93	76874	53962
888	Snap Ring, Holds Pinion Pins In Differential Housing (Spiral)	1	84-93	76874A	53962S
906E	Spring, 1-2 Servo Cushion 1st Design (Orange/Green) (Inner)	1	84-93	84906B	66968
907E	Piston, 1-2 Servo	1	84-93	84907	N/A
908E	Pin, 1-2 Servo (2.215") 1 Ring & 1 Wide Band	1	84-93	84908	66875
908E	Pin, 1-2 Servo (2.295") 2 Ring	1	84-93	84908B	66707
908E	Pin, Servo Extendto Fits Both Servos (Teckpak)	1	84-93	T84908	66875
913E	Pin, Reverse Apply (2.915") 1 Groove & 1 Wide Band	1	84-93	84913C	66708D
913E	Pin, Reverse Apply (3.080") 3 Groove	1	84-93	84913G	66708C
925E	Accumulator Assembly, 1-2	1	84-93	84925	N/A
926E	Spring, 1-2 Accumulator (Orange/Green)	1	84-93	84926	66706
926E	Spring, 1-2 Accumulator (Plain Colored)	1	84-93	84926B	N/A
926E	Spring, 1-2 Accumulator (White)	1	84-93	84926C	66706B
926E	Spring, 1-2 Accumulator (Red)	1	84-93	84926D	N/A
927E	Piston, 1-2, 3-4 Accumulator (Deep w/o Spring Recess) (Aluminum)	1	84-93	84927	66993
927E	Piston, 1-2, 3-4 Accumulator (Aluminum Replacement) Transgo	1	84-93	A84927	N/A
927E	Piston Kit, Accumulator 1-2, 3-4 (2 Pistons, 1 Spring, 1 Spacer) Transgo	1	84-93	84927EK	K66993
928E	Pin, 1-2 & 3-4 Accumulator	1	84-93	84928	66994
928E	Pin, Oversized Accumulator Allows Re-use of Worn Piston	1	84-93	84928X	66994P
928E	Pin & Reamer Kit, Includes OS Pin & Reamer for Boring Original Piston	1	84-93	84928XK	T-9149
929E	Cover, 1-2 & 3-4 Accumulator (Cast # 8677163)	1	84-93	84929	N/A
936A	Spring, 3-4 Accumulator (Orange or Blue)	1	84-93	84936	66706A
937A	Piston, 1-2, 3-4 Accumulator (Deep w/o Spring Recess) (Aluminum)	1	84-93	84927	66993
937A	Piston Kit, Accumulator 1-2, 3-4 (2 Pistons, 1 Spring, 1 Spacer) Transgo	1	84-93	84927EK	K66993
940A	Accumulator Assembly, TCC Piston & Rod Update Kit	1	84-93	84940A	DK66963
962B	Piston, 2nd Clutch Drum	1	84-93	84962	66929
962B	Piston, 2nd Clutch Drum (5 1/8" OD)	1	84-93	84962E	66929A
964H	Piston, Input Clutch (Converts to 10 Clutch if D84554B is Used)	1	84-93	84964B	66934
965H	Piston, 3rd Clutch (w/ Molded Rubber) (w/ Check Ball)	1	84-93	84965A	66917A
971G	Springs w/ Retainer, 4th Clutch (3 3/8" ID)	1	84-93	84971	66931
974H	Spring & Retainer, Input Clutch (16 Springs)	1	84-93	84974	66923
975H	Guide w/ Spring Retainer, 3rd Clutch (12 Springs)	1	84-93	84975	66924
989	Retainer, Input Sprag Clutch (Late)	1	87-93	84989A	66925
994	Park Rod (.440" OD of Tip) 15-1/5" Long	1	91-93	84994B	N/A
996	Cooler Line Fitting	1	84-93	84996	96-441
Tool	Input Shaft Teflon Seal Installer	1	84-93	T-2004	T-2004
Tool	Thermo Element Height Gauge	1	84-93	T-2006	T-2006
Tool	Input Clutch Piston Lip Seal Installer	1	84-93	T-2027	T-2027
Tool	3rd Clutch Piston Lip Seal Installer	1	84-93	T-2028	T-2028
Tool	2nd Clutch Piston Lip Seal Installer	1	84-93	T-2056	T-2056

440-T4, 4T60

4T60E(M13), 4T65E(MN3, M15, MN7 H.D., M76)

ELECTRONIC 4 SPEED - FWD

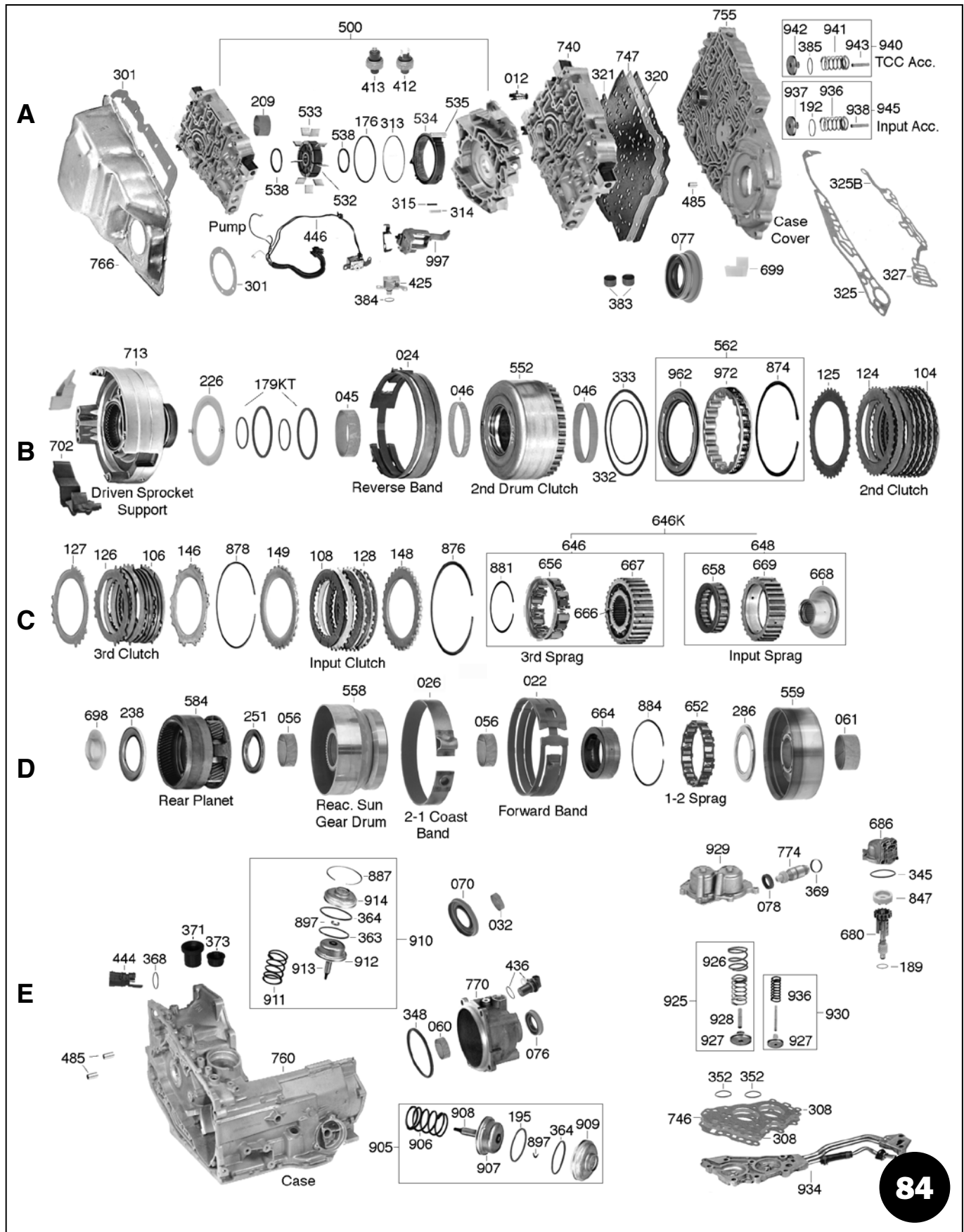

ELECTRONIC 4 SPEED - FWD

4T60E(M13), 4T65E(MN3, M15, MN7 H.D., M76)

4T60E, 4T65E

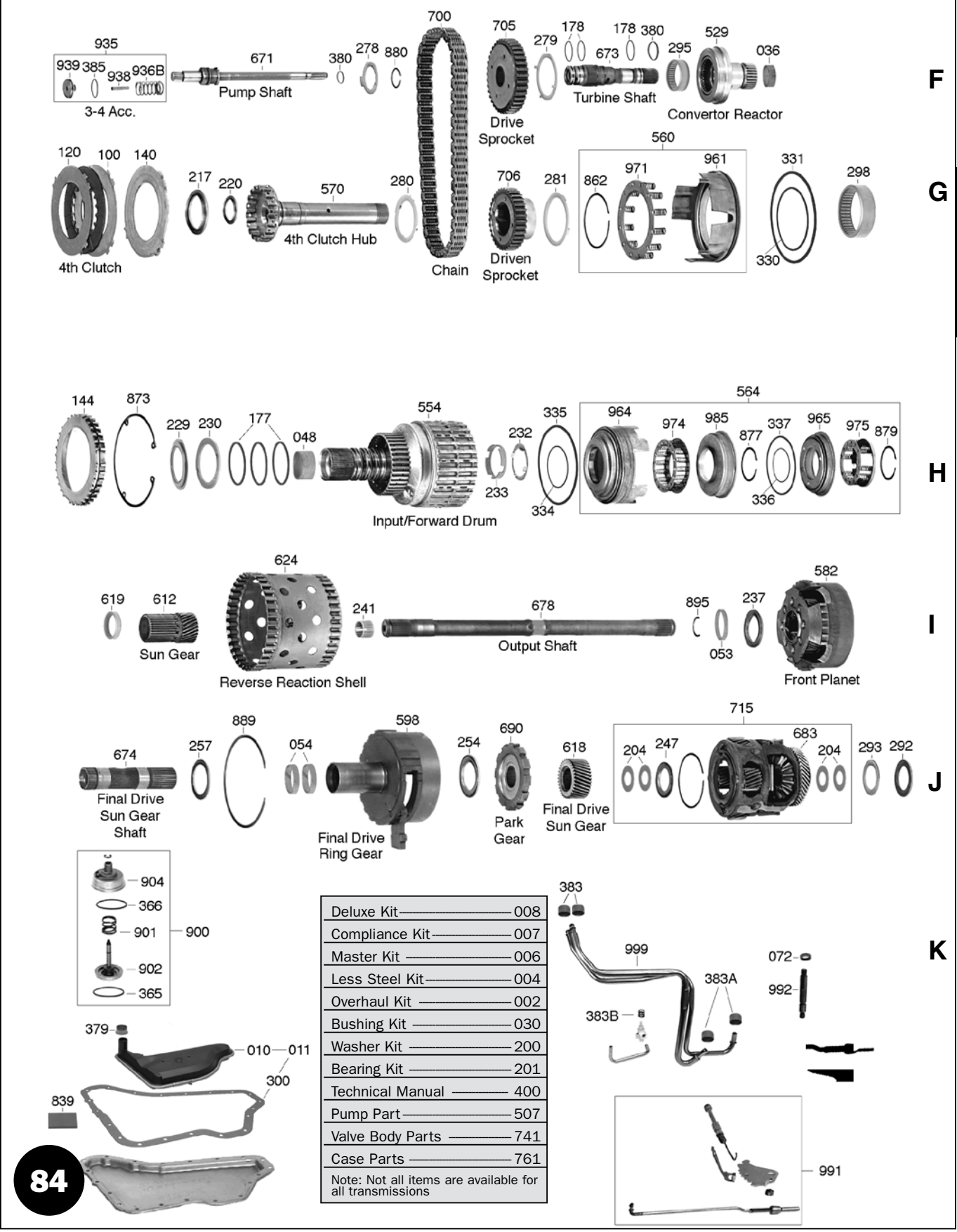

4T60E(M13), 4T65E(MN3, M15, MN7 H.D., M76)

ELECTRONIC 4 SPEED - FWD

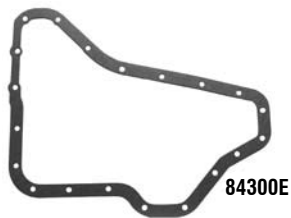

84300E

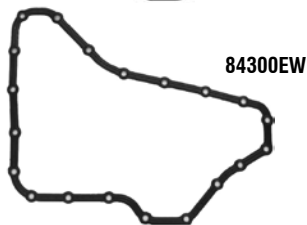

84300EW

BUICK	
Century	A
Electra, Park Avenue.....	C
LeSabre	H
Park Avenue.....	Ultra
Reatta	Z
Regal.....	G
Riviera.....	E
Skylark, Somerset.....	N

CADILLAC	
Allente	
Brougham, DeVille.....	C
ElDorado.....	E
Fleetwood.....	C
Seville.....	K

CHEVROLET	
Beretta, Celebrity, Corsica	
Lumina Z-34	A

OLDSMOBILE	
Ciera.....	A
Cutlass Cruiser	A
Cutlass Supreme	
Delta 88	H
98 Regency	C
Royale	H
Silhouette.....	U
Toronado	E
Trofeo	

PONTIAC	
6000.....	A
Bonneville.....	H
Grand Prix.....	G&W
Transport.....	U

VOLVO	
99-Up	



84010E

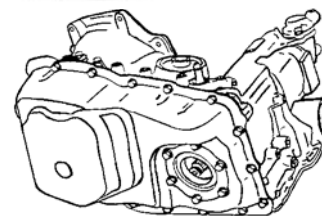

4T60E CASE

ILL.	DESCRIPTION	QTY.	YEAR	PART NO.	REFERENCE NO.
DELUXE KITS (SUPER KITS) (1) (2) (3)					
008K	4T60E (w/o Pistons)	1	91-E94	84008EW	N/A
008K	4T60E (w/o Pistons)	1	L94-99	84008EAW	K6600F-R
008K	4T60E (w/ Pistons) Combo	1	91-99	84008EBPW	K6600E-R
008K	4T65E (w/ Pistons) (also 2003 w/ Sprag Type Input Clutch) (Exc Volvo)	1	97-03	84008GPW	K6600H-R
008K	4T65E (w/ Pistons) (also 2003 w/ Pawl Type Input Clutch) (Exc Volvo)	1	03-Up	84008HPW	N/A
COMPLIANCE KITS (CALIFORNIA KITS) (1) (2) (3)					
007K	4T60E (w/o Pistons)	1	91-E94	84007EW	N/A
007K	4T60E (w/o Pistons)	1	L94-99	84007EAW	CK6600F-R
007K	4T60E (w/ Pistons) Combo	1	91-99	84007EBPW	CK6600E-R
007K	4T65E (w/ Pistons) (also 2003 w/ Sprag Type Input Clutch) (Exc Volvo)	1	97-03	84007GPW	CK6600H-R
007K	4T65E (w/ Pistons) (also 2003 w/ Pawl Type Input Clutch) (Exc Volvo)	1	03-Up	84007HPW	N/A
MASTER OVERHAUL KITS (WITH STEELS) (1) (2) (3)					
006K	4T60E (w/o Pistons)	1	91-E94	84006EW	K6600E
006K	4T60E (w/o Pistons)	1	L94-99	84006EAW	K6600F
006K	4T60E (w/ Pistons) Combo	1	91-99	84006EBPW	K6600E
006K	4T65E (w/ Pistons) (also 2003 w/ Sprag Type Input Clutch) (Exc Volvo)	1	97-03	84006GPW	K6600H
006K	4T65E (w/ Pistons) (also 2003 w/ Pawl Type Input Clutch) (Exc Volvo)	1	03-Up	84006HPW	K6600J
006K	4T65E (w/ Pistons) (Volvo)	1	99-02	84006GAPW	K6600V
LESS STEEL KITS (1) (2) (3)					
004K	4T60E (w/o Pistons)	1	91-E94	84004EW	K6600E-LS
004K	4T60E (w/o Pistons)	1	L94-99	84004EAW	K6600F-LS
004K	4T60E (w/ Pistons) Combo	1	91-99	84004EBPW	K6600E-LS
004K	4T65E (w/ Pistons) (also 2003 w/ Sprag Type Input Clutch) (Exc Volvo)	1	97-03	84004GPW	K6600H-LS
004K	4T65E (w/ Pistons) (also 2003 w/ Pawl Type Input Clutch) (Exc Volvo)	1	03-Up	84004HPW	K6600J-LS
004K	4T65E (w/ Pistons) (Volvo)	1	99-02	84004GAPW	K6600V-LS
OVERHAUL KITS (W/ RINGS & SEALS) (1) (2) (3)					
002K	4T60E (w/o Pistons)	1	91-99	84002EW	K66900E
002K	4T65E (w/o Pistons)	1	99-Up	84002GW	K66900H
GASKET & SEAL KITS (W/O RINGS & SEALS) (1) (2) (3)					
000K	4T60E (w/o Pistons)	1	91-99	84000EW	K66900E-1
000K	4T65E (w/o Pistons)	1	99-Up	84000GW	K66900H-1
	<p>(1) - "W" suffix kits incl. Bonded pan gasket. To order Kits with Fiber pan gaskets, use an "F" suffix</p> <p>(2) - Bonded Side Cover Gasket not included in kits.</p> <p>(3) - For 4T65E Volvo, order GAPW kit or GPW kit plus subkit # 84001G</p>				

ELECTRONIC 4 SPEED - FWD

4T60E(M13), 4T65E(MN3, M15, MN7 H.D., M76)

ILL.	DESCRIPTION	QTY.	YEAR	PART NO.	REFERENCE NO.
FILTER KITS					
011K	Filter Kit, 4T60E (Bonded Pan Gasket)	1	91-99	84011EW	N/A
011K	Filter Kit, 4T60E (Fiber Pan Gasket).....	1	91-99	84011E	FFK66710F
FILTERS					
010K	Filter	1	91-Up	84010E	66710F
012A	Screen, Oil Pump (w/ Tab).....	1	91-Up	84012	66712
012A	Screen, Oil Pump (No Tab).....	1	91-Up	84012A	66712A
016	Screen, Shift Solenoid.....	3-4	91-Up	84016E	66714F
016	Screen, TCC Orifice.....	1	91-Up	84016PA	66714
017	Screen, Servo	1	91-Up	84017A	66714E
BANDS					
Prefix Key: B = Borg Warner, A = OEM (Exc BW), N = All Other New, R = Relined					
022D	Forward (Rear).....	1	91-Up	84022E	66700E
022D	Forward (Rear) (Hi-Energy)	1	01-Up	84022G	66700EH
024B	Reverse (Front)	1	91-Up	84024A	66720E
024B	Reverse (Front) (Hi-Energy).....	1	01-Up	84024G	66720EH
026D	2-1 Coast (Center)	1	91-Up	84026A	66705
026D	2-1 Coast (Center) (Hi-Energy).....	1	91-Up	84026G	66705H
BUSHINGS					
030K	Bushing Kit, 4T60E	1	91-99	84030E	K66901E
030K	Bushing Kit, 4T65E	1	97-Up	84030G	K66901F
032E	Converter Hub.....	1	91-Up	64032B	51005A
036F	Stator Support Front.....	1	91-Up	54036A	32006
045B	Driven Sprocket Support	1	91-Up	84045	66010
046B	2nd Clutch Housing (Rear)	1	91-Up	84046	66012
046B	2nd Clutch Housing (Front)	1	91-Up	84046B	66011
048H	Input Drum (w/ Oil Grooves).....	1	91-Up	84048A	66013
053I	Front Planet (4T60E Only)	1	91-99	84053	66015
054J	Final Drive Internal Gear Shaft.....	2	91-Up	84054	66017
056D	Rear Sun Gear (Forward Band Drum) (Wide Front Bushing)	1	91-Up	84056AA	66016A
056D	Rear Sun Gear (Forward Band Drum) (Narrow Rear Bushing).....	1	91-Up	84056AB	66016B
060E	Bushing, Case.....	2-3	91-Up	64060	51013
061D	2-1 Coast Drum (11/16" Wide) (Center Band Drum).....	1	91-95	84056AA	66016A
061D	2-1 Coast Drum (1 1/4" Wide) (Center Band Drum).....	1	96-Up	84061B	66016C
090	Channel Plate Repair Plate, Elim. Oil Leakage.....	1	91-99	84090	66996P
METAL CLAD SEALS					
070E	Front.....	1	91-Up	84070	51200AV
072K	Manual Lever	1	91-Up	84072A	51202A
075	Seal, Axle Stabilizer (Teckpak)	1	91-99	T84075	51731BS
076E	Axle (Right Side Only) (Exc 4T65E Volvo)	1	91-Up	84076	51201
076E	Axle (Right Side) (4T65E Volvo)	1	97-Up	84076GA	66220D
077A	Axle (Left Side Only) (4T60E).....	1	91-99	84077	66220A
077A	Axle (Left Side Only) (4T65E).....	1	97-Up	84077G	66220C
FRICTION PLATES					
100G	4th Clutch (18 T) (4T60E)	2	91-99	84100A	66104A
100G	4th Clutch (32 T) (4T65E)	2	97-Up	84100G	66104E
100G	4th Clutch (32 T) (4T65E) (Hi-Performance).....	2	97-Up	84100GHP	66104EX
100G	4th Clutch (1 Sided, Internal T) (4T65E) Volvo & 05-Up GM.....	2	99-Up	84100GA	66104H
120G	4th Clutch (1 Sided, External T) (4T65E) Volvo & 05-Up GM	2	99-Up	84120GA	66104J

4T60E, 4T65E

ILL.	DESCRIPTION	QTY.	YEAR	PART NO.	REFERENCE NO.
FRICITION PLATES (Cont.)					
104B	2nd Clutch (38 T) (4T60E)	5-6	91-99	84104A	66102A
104B	2nd Clutch (38 T) (4T60E) (Hi-Energy).....	5-6	91-99	84104AH	66102AH
104B	2nd Clutch (42 T) (4T65E)	6	97-Up	84104G	66102E
104B	2nd Clutch (42 T) (4T65E) (Hi-Performance).....	6	97-Up	84104GHP	66102EX
106C	3rd Clutch (.082") (1 Sided, 32 Internal T)	5	91-Up	84106B	66103C
106C	3rd Clutch (.082") (1 Sided, 32 Internal T) (Hi-Performance)	5	91-Up	84106BHP	66103CX
106C	3rd Clutch (.082") (1 Sided, 32 Internal T) (Hi-Energy).....	5	01-Up	84106C	66103H
126C	3rd Clutch (.078") (1 Sided, 12 External T)	5	91-Up	84126AB	66103D
126C	3rd Clutch (.078") (1 Sided, 12 External T) (Hi-Performance).....	5	91-Up	84126ABHP	66103DX
126C	3rd Clutch (.078") (1 Sided, 12 External T) (Hi-Energy).....	5	01-Up	84126C	66103J
108C	Input Clutch (.090") (32 T)	4	91-E94	84108	66106
108C	Input Clutch (.065") (32 T)	4	L94-Up	84108A	66106A
108C	Input Clutch (.065") (32 T) (Hi-Performance).....	4	L94-Up	84108AHP	66106AX
108C	Input Clutch (30 T) (Used w/ Pawl Type Sprag).....	4	03-Up	84108B	66106B
108C	Input Clutch (30 T) (Used w/ Pawl Type Sprag) (Hi-Performance)	4	03-Up	84108BHP	66106BX
STEEL PLATES					
120G	4th Clutch (.074") (5 T) (4T60E)	2	91-99	84120B	N/A
120G	4th Clutch (.077") (5 T) (4T60E)	2	91-99	84120	66204
120G	4th Clutch (.083") (3 T) (4T65E)	2	97-Up	84120G	66204E
124B	2nd Clutch (.077") (34 T) (4T60E).....	6	91-99	84124A	66202E
124B	2nd Clutch (.077") (34 T) (4T60E) (Kolene).....	6	91-99	84124D	66202D
125B	2nd Clutch (.044") (34 T) (4T60E) (Waved).....	1	91-99	84125	66202B
124B	2nd Clutch (.068") (36 T) (4T65E).....	5	97-Up	84124G	66202G
124B	2nd Clutch (.090") (36 T) (4T65E).....	AR	97-Up	84124GA	66202H
125B	2nd Clutch (.065") (36 T) (4T65E) (Waved).....	1	97-Up	84125G	66202F
126C	3rd Clutch (.090") (4T60E).....	1	91-99	84126	66203
127C	3rd Clutch (.030") (4T60E) (Waved).....	1	91-99	84127	66203B
128C	Input Clutch (.076").....	3-4	91-Up	64128	51100
128C	Input Clutch (.050").....	4	91-Up	84128	66100
129	Input Clutch (.040") (Waved).....	1	91-Up	64129	51105
FRICITION & STEEL KITS					
N.I.	Friction & Steel Kit, 4th Clutch .070" (Bent Tooth) (2 Fri. & 2 Thin Steels)	1	91-92	A84100BPK	K66104BX
N.I.	Friction & Steel Kit, 4th Clutch .070" (Bent Tooth) (2 Fri, 2 Thin & 1 Thick Steel)	1	93-99	A84100BAPK	K66104CX
N.I.	Friction & Steel Kit, 2nd Clutch .060" (Power Pack) (7 Fri, 6 Thin & 1 Thick Steel).....	1	91-99	A84104CPK	N/A
N.I.	3rd Clutch Z Pack.....	1	91-Up	84106K	K66103Z
N.I.	Update Kit, 2nd Clutch.....	1	91-Up	84100AAK	K66-66
N.I.	Clearance Pack, Forward, 2nd, 3rd Clutch	1	91-Up	84119K	K66-66F
N.I.	Steel Module (4T60E)	1	91-E94	84139E	N/A
N.I.	Steel Module (4T60E)	1	L94-99	84139EA	N/A
N.I.	Steel Module (4T60E)	1	91-99	84139EB	N/A
N.I.	Steel Module (4T65E)	1	97-Up	84139G	N/A
PRESSURE PLATES					
Prefix Key: D = OEM, A = Aftermarket New, R = Remanufactured					
140G	4th Clutch (.160") (4T60E)	1	91-92	84140A	66210J
140G	4th Clutch (.135") (4T60E)	2-3	93-99	84140B	66204A
140G	4th Clutch (.128") (4T65E)	1	97-Up	84140G	66210M
144H	2nd Clutch Backing (Beveled) (.125") (4T60E).....	1	91-99	84144C	66210D
144H	2nd Clutch Backing (Beveled) (.390") (4T60E).....	1	91-99	84144D	66210K
144H	2nd Clutch (.227") (4T65E)	1	97-Up	84144E	66210N
145	2nd Clutch Apply (Flat) (Bottom) (.135") (4T60E).....	1	91-99	84145A	66210L
145	2nd Clutch Apply Plate (.130") (4T60E).....	1	91-99	84146B	N/A
145	2nd Clutch Apply (.152") (4T65E)	1	97-Up	84148C	66210P
146C	3rd Clutch Backing (.150")	1	91-Up	84146A	66210H

ELECTRONIC 4 SPEED - FWD

4T60E(M13), 4T65E(MN3, M15, MN7 H.D., M76)

ILL.	DESCRIPTION	QTY.	YEAR	PART NO.	REFERENCE NO.
PRESSURE PLATES (Cont.)					
148C	Input Clutch Backing (.190") (Top).....	1	91-Up	84148	51714
149C	Input Clutch Apply (.190") (Bottom).....	1	91-Up	84149	66206
MODULATORS					
160E	Black & Red Stripe (Single Line) Diesel.....	1	91-99	84160B	66820Y
160E	Red Stripe (Dual Line) (GM Universal)	1	91-99	84160R	66820X
160E	Modulator Kit (w/ Large Can Modulator, Valve, & Gaskets).....	1	91-99	84160K	DK66820B
163E	Valve, Modulator	1	91-99	84163A	66821A
VALVE BODY RECALIBRATION KITS					
165K	Lube Kit, Lube & End Play Kit (4T60E) (Transgo®).....	1	91-99	T84165LE	K66908L
165K	Valve Body Kit, Shift Correction Package (4T65E) (Superior).....	1	97-Up	S84165G	66C04
165K	Shift Kit-Jr®, Junior (4T60E) (Transgo®).....	1	91-99	T84167E	K66908E
165K	Shift Kit® (4T65E) (Transgo®)	1	97-04	T84167G	K66908G
165K	Sure Cure Kit (4T60E) (requires T-84754-TL5) (Sonnax).....	1	93-96	S84174	66S02
165K	Sure Cure Kit (4T60E) (requires T-84754-TL5 & DJ2) (Sonnax)	1	97-99	S84174A	66S03
165K	Sure Cure Kit (4T65E) (requires T-84754-TL3, T-F-84596-TL, T-VB-FIX) (Sonnax)	1	97-Up	S84174G	66S05
SEALING RINGS					
175K	Ring Kit (4T60E)	1	91-99	84175E	N/A
175K	Ring Kit (4T65E)	1	97-Up	84175G	K66300BT
175K	Ring Kit (2 Vespel Rings & 2 Rubber Expanders)	1	91-99	84179KT	N/A
177H	Input Shaft (Solid)	1	91-99	64178AT	51310T
178F	Turbine Shaft (Front) (Solid)	1	91-Up	64178AT	51310T
178F	Turbine Shaft (Rear) (Solid)	2	91-Up	64178BT	51307T
179B	2nd Clutch (4T60E).....	2	91-99	84179BT	N/A
179B	2nd Clutch (4T65E) (.125" Wide Plastic)	2	97-E98	84179T	N/A
179B	2nd Clutch (4T65E) (.100" Wide Plastic)	2	L98-Up	84179AT	N/A
192A	Input Clutch Accumulator	1	91-Up	84192T	N/A
195E	1-2 Reverse Servo	1	91-Up	84195T	N/A
THRUST WASHERS					
200K	Washer Kit (4T60E) (No Selectives).....	1	91-99	84200	K66400
200K	Washer Kit (4T60E) (w/ Popular Selectives).....	1	91-99	84200B	N/A
200K	Washer Kit (4T65E).....	1	97-Up	84200G	K66400E
226B	Driven Sprocket Support to 2nd Clutch Drum (4T60E).....	1	91-99	84226	66412
226B	Driven Sprocket Support to 2nd Clutch Drum (4T65E).....	1	97-Up	84226G	66412A
230H	Input Drum 2.90-3.00mm (Orange-Green).....	1	91-Up	84230	66415A
230H	Input Drum 3.05-3.15mm (Orange-Black)	1	91-Up	84230A	66415B
230H	Input Drum 3.20-3.30mm (Orange).....	1	91-Up	84230B	66415C
230H	Input Drum 3.35-3.45mm (White)	1	91-Up	84230C	66415D
230H	Input Drum 3.50-3.60mm (Blue)	1	91-Up	84230D	66415E
230H	Input Drum 3.65-3.75mm (Pink)	1	91-Up	84230E	66415F
230H	Input Drum 3.80-3.90mm (Brown).....	1	91-Up	84230EA	66415G
230H	Input Drum 3.95-4.05mm (Green).....	1	91-Up	84230G	66415H
230H	Input Drum 4.10-4.20mm (Black)	1	91-Up	84230H	66415J
230H	Input Drum 4.25-4.35mm (Purple).....	1	91-Up	84230HA	66415K
230H	Input Drum 4.40-4.50mm (Purple-White)	1	91-Up	84230J	66415L
263	4th Hub to Case Cover (3 Tabs) (Teflon Coated) (4T65E).....	1	97-Up	84263G	66421
278F	Drive Sprocket to Channel Plate (4T60E)	1	91-99	84278	66411
278F	Drive Sprocket to Channel Plate (4T65E)	1	97-Up	84278G	66411A
279F	Drive Sprocket to Support (4T60E).....	1	91-99	84279A	51413
279F	Drive Sprocket to Support (3 Round Solid Tabs) (4T65E).....	1	97-00	84279G	66420
279F	Drive Sprocket to Support (3 Split Locking Tabs) (4T65E).....	1	01-Up	84279H	66420A

4T60E, 4T65E

4T60E(M13), 4T65E(MN3, M15, MN7 H.D., M76)

ELECTRONIC 4 SPEED - FWD

ILL.	DESCRIPTION	QTY.	YEAR	PART NO.	REFERENCE NO.
THRUST WASHERS (Cont.)					
280G	4th Clutch Hub to Driven Sprocket (4T60E).....	1	91-99	84280	66414
280G	4th Clutch Hub to Driven Sprocket (4T65E).....	1	97-Up	84280G	66414A
281G	Driven Sprocket to Support (4 Legs) (4T60E).....	1	91-99	84281	66410
281G	Driven Sprocket to Support (3 Legs) (4T65E).....	1	97-Up	84281G	66410A
N.I.	Repair Kit, Final Drive Planet (16 Steel Washers) (Small).....	1	91-Up	64204C	K51440
N.I.	Repair Kit, Final Drive Planet (16 Steel Washers) (.850" OD, .440" ID).....	1	91-Up	84204B	N/A
N.I.	Repair Kit, Final Drive Planet (8 Brass & 8 Steel Washers) Early.....	1	91-Up	64204D	K51440A
BEARINGS					
201K	Bearing Kit.....	1	91-Up	84201A	K66500
209	Bearing, Pump Shaft.....	1	91-99	84209	66520
217G	Bearing, 4th Clutch Hub to Channel Plate.....	1	91-99	84217	66508
220G	Bearing, 4th Clutch Hub.....	1	91-99	84220A	66952
229H	Bearing, 2nd Clutch Drum to Input Drum.....	1	91-Up	84229	66504
232H	Bearing, Input Drum Rear.....	1	91-Up	84232A	66413A
238D	Bearing, Front Planet to Rear Planet.....	1	91-Up	84238	66502
241I	Bearing, Sun Gear (Split, Inner) (3/4" Long).....	1	91-6/93	84241A	66521A
247J	Bearing, Sun Gear to Differential Carrier (2.00" OD).....	1	91-Up	54247A	32409A
247J	Bearing, Sun Gear to Differential Carrier (2.125" OD).....	1	91-Up	84247	51454
247J	Bearing, Sun Gear to Differential Carrier (2.250" OD).....	1	91-Up	84247A	66514
251D	Bearing, Rear Planet to Sun Gear Drum.....	1	91-Up	84251	66501
254J	Bearing, Internal Gear to Part Gear.....	1	91-95	84254	66506
254J	Bearing, Internal Gear to Part Gear.....	1	96-Up	84254A	66506A
257J	Bearing, Reaction Drum to Internal Ring Gear.....	1	91-Up	84257	66509
257J	Race, Reaction Drum to Internal Ring Gear .140".....	1	91-Up	84257B	66417
275	Axle Stabilizer, Passenger Side (w/ Bearing & Seal).....	1	91-Up	T64275	51731B
275	Axle Stabilizer, Driver Side (w/ Bearing & Seal).....	1	91-99	T84275	66731B
286D	Bearing, 1-2 Sprag to Forward Band Drum.....	1	91-95	54242AA	32408A
286D	Bearing, 1-2 Sprag to Forward Band Drum.....	1	96-Up	84286C	66507
242	Bearing, Between 1-2 Roller Housing & Race.....	1	91-99	54242AA	32408A
292J	Bearing, Differential to Case.....	1	91-Up	64292	51461
295F	Needle Bearing, Converter Reactor (Presses Inside).....	1	91-Up	64295	51486
298G	Needle Bearing, Driven Sprocket Support (Presses Inside).....	1	91-Up	84298	66954
SHIMS & SPACERS					
230H	Shim Kit (.010") (10 Per Kit).....	1	91-Up	84230S	66415S
230H	Shim Kit (.020") (10 Per Kit).....	1	91-Up	84230SA	66415T
233H	Sleeve, Input Drum Rear (4 Notches).....	1	91-Up	84741C-2	66932
257J	Race, Reaction Drum to Internal Ring Gear .140".....	1	91-Up	84257B	66417
293J	Spacer, Differential to Case 1.65mm (#2).....	1	91-Up	64293B	51417A
293J	Spacer, Differential to Case 1.75mm (#3).....	1	91-Up	64293C	51417B
293J	Spacer, Differential to Case 1.85mm (#4).....	1	91-Up	64293D	51417C
293J	Spacer, Differential to Case 1.95mm (#5).....	1	91-Up	64293E	51417D
293J	Spacer, Differential to Case 2.05mm (#6).....	1	91-Up	64293F	51417E
293J	Spacer, Differential to Case 2.15mm (#7).....	1	91-Up	64293G	51417F
293J	Spacer, Differential to Case 2.25mm (#8).....	1	91-Up	64293H	51417H
293J	Spacer, Differential to Case 2.35mm (#9).....	1	91-Up	64293J	51417J
293J	Shim, Differential Carrier to Case.....	1	91-Up	84293S	51417S
GASKETS & O-RINGS					
300K	Bottom Pan (Cork) (4T60E).....	1	91-99	84300E	13966AR
300K	Bottom Pan (Fiber) (4T60E).....	1	91-99	84300EF	13966AF
300K	Bottom Pan (Bonded) (8mm Pan Bolts).....	1	91-Up	84300EW	13966AR
300K	Bottom Pan (Bonded) (6mm Pan Bolts).....	1	L98-Up	84300EAW	13966BR

ELECTRONIC 4 SPEED - FWD

4T60E(M13), 4T65E(MN3, M15, MN7 H.D., M76)

ILL.	DESCRIPTION	QTY.	YEAR	PART NO.	REFERENCE NO.
GASKETS & O-RINGS (Cont.)					
301A	Side Cover (Outer) (4T60E) (Cork)	1	91-93	84301	13450
301A	Side Cover (Outer) (4T60E) (Fiber)	1	91-93	84301F	13450F
301A	Side Cover (Outer) (4T60E) (Bonded)	1	94-99	84301E	13450R
301A	Side Cover (Outer) (4T65E) (Bonded)	1	97-Up	84301GW	13453R
301A	Side Cover (Inner) (4T60E)	1	91-93	84301J	13451
301A	Side Cover (Inner) (4T60E) (Lathe Cut)	1	94-99	84301LA	13451R
301A	Side Cover (Inner) (4T65E) (Lathe Cut)	1	97-Up	84301GA	13451AR
308E	Gasket, Accumulator Cover (w/ Spacer Plate) (4T60E)	1	91-99	84308A	13452E
308E	Gasket, Accumulator Cover (w/ Spacer Plate) (4T65E)	1	97-Up	84308G	13452F
313A	O-Ring, Pump Slide Back-Up	1	91-Up	84313	13982A
314A	Seal, Pump Slide (Rubber)	1	91-Up	54314B	13768
315A	Seal, Pump Slide (Teflon)	1	91-Up	54315B	13762
320A	Gasket, Valve Body Spacer Plate to Channel Plate (4T60E)	1	91-92	84320B	13788A
320A	Gasket, Valve Body Spacer Plate to Channel Plate (4T60E)	1	93-99	84320BA	13788B
320A	Gasket, Valve Body Spacer Plate to Channel Plate (4T65E)	1	97-Up	84320G	13788E
320A	Gasket, Valve Body Separator Plate (Bonded) (4T65E)	1	99-03	84320K	13787M
320A	Gasket, Valve Body Separator Plate (Bonded) (4T65E)	1	04-Up	84320L	13787N
320A	Gasket Kit, Valve Body (4T65E) (Volvo)	1	97-Up	84320GAK	N/A
321A	Gasket, Valve Body to Spacer Plate (4T60E)	1	91-92	84321B	13787A
321A	Gasket, Valve Body to Spacer Plate (4T60E)	1	93-99	84321BA	13787B
321A	Gasket, Valve Body to Spacer Plate (4T65E)	1	97-Up	84321G	13787E
325A	Gasket, Lower Channel Plate (4T60E)	1	91-99	84325A	13805A
325A	Gasket, Lower Channel Plate (4T65E)	1	97-Up	84324G	13805B
325A	Gasket Kit, Channel Plate (4T60E)	1	91-99	84325AK	N/A
325A	Gasket, Upper Channel Plate (4T60E)	1	91-99	84325E	13806A
325A	Gasket, Upper Channel Plate (4T65E)	1	97-Up	84325G	13806B
348E	Lathe Cut Seal, Extension Housing to Case	1	91-Up	84348	13781
352E	Lathe Cut Seal, 1-2 & 3-4 Accumulator Piston	2	91-Up	54352A	13965
354F	O-Ring, 3-4 Accumulator	1	91-Up	84354A	N/A
360	Seal, 1-2 Servo Cover (4T65E)	1	97-Up	84360	N/A
362	O-Ring, 2-1 Servo Cover to Case .066"	1	91-E95	84362A	N/A
362	O-Ring, 2-1 Servo Cover to Case .132"	1	L95-Up	84362B	N/A
363E	Lip Seal, Reverse Servo Piston	1	91-Up	84363A	N/A
364E	O-Ring, Reverse Servo Cover (4T60E)	1	91-Up	84364	13803
364E	O-Ring, Reverse Servo Cover (4T65E)	1	99-Up	84364C	13803A
364E	O-Ring, Forward Servo Cover	1	91-Up	84364B	N/A
371E	Boot, Filler Tube	1	91-Up	44371B	13925
376	O-Ring, Converter Clutch Solenoid Screen	1	91-Up	84376	13795
379K	Seal, Filter Seal	1	91-Up	84379	13987
380F	O-Ring, Turbine Shaft	1	91-Up	64380	13766
TECHNICAL MANUALS					
400K	Tech Manual (4T60E)	1	91-99	84400E	66Y03
400K	Tech Manual (4T65E)	1	97-Up	84400G	66Y07
400K	Tech Manual (4T65E) Update	1	97-Up	84400J	66Y08
400K	Transmission Guide (GM) (4T60E)	1	91-99	84400EB	N/A
400K	Transmission Guide (GM) (4T65E)	1	97-Up	84400GA	N/A
400K	Tech Video, 4T60E (Includes Manual) (4T60E)	1	91-99	84407E	N/A
ELECTRICAL COMPONENTS					
410	Switch, MLPS (1 Connector w/ 7 Pins, 1 Connector w/ 4 Pins)	1	96-Up	84410HA	N/A
410	Switch, MLPS (1 Connector w/ 6 Pins)	1	99-Up	84410H	15D-329
412A	Switch, Pump TCC Pressure (1 Prong N.O.)	1	91-99	74411B	15A-118
413A	4th Clutch Pressure Switch (1 Prong)	1	91-99	84413A	15D-131A

4T60E, 4T65E

4T60E(M13), 4T65E(MN3, M15, MN7 H.D., M76)

ELECTRONIC 4 SPEED - FWD

ILL.	DESCRIPTION	QTY.	YEAR	PART NO.	REFERENCE NO.
ELECTRICAL COMPONENTS (Cont.)					
418	Solenoid, TCC PWM.....	1	91-99	84418A	5A-160
418	Solenoid, TCC PWM (Teckpak).....	1	91-99	T84418A	5T-160
420	Solenoid Master Kit (4T60E).....	1	91-99	84420K	N/A
420	Solenoid Master Kit (4T65E).....	1	97-Up	84420AK	N/A
421	Solenoid, 1-2, 3-4 Shift (4T60E).....	2	91-99	84421	5R-144
421	Solenoid, 1-2, 3-4 Shift (4T65E) (Rostra) (D14421A does not fit).....	2	97-Up	14421A	5D-188
421	Solenoid, 1-2, 3-4 Shift (4T65E) (OEM).....	2	97-Up	D84421G	5D-167
425	Solenoid, Lock-up (TCC) (4T60E).....	1	91-99	84421	5R-144
425	Solenoid, Lock-up (TCC) (4T65E) (replaces 84425A).....	1	97-Up	74418E	5B-187
431	Solenoid, EPC (4T65E) (Holley).....	1	97-02	84431G	5A-186
431	Solenoid, EPC (4T65E) (Bosch).....	1	03-Up	84431H	5D-186B
436E	Sensor, Output Speed (VSS) (4T60E).....	1	91-99	84436A	20D-200
436E	Sensor, Output Speed (VSS) (4T65E) (Short Connector 2" Tall).....	1	97-99	84436A	20D-200
436E	Sensor, Output Speed (VSS) (4T65E) (Long Connector).....	1	99-Up	84436G	20A-200A
437	Switch, Temperature.....	1	91-99	84437B	N/A
437	Sensor, Temperature (TOT).....	1	91-99	84437E	N/A
438	Sensor, Input Speed (TSS) (4T65E) (Exc 99-Up Volvo).....	1	97-Up	84438G	20D-210
438	Sensor, Input Speed (TSS) (4T65E) (99-Up Volvo).....	1	99-Up	84438GA	N/A
442	Switch, Manifold (Pressure Range Sensor) (4T65E) 4 Prong.....	1	97-02	84442G	15D-167
442	Switch, Manifold (Pressure Range Sensor) (4T65E) 1 Prong.....	1	03-Up	84442H	15D-167A
444E	Connector (Round 7 Prong Black).....	1	94-99	84444C	25D-112
445	Repair Kit, External Wire Harness.....	1	91-93	84445K	N/A
445	Repair Kit, External Wire Harness.....	1	94-98	84445AK	N/A
446	Repair Kit, Speed Sensor Connector.....	1	91-99	74446CK	35R-216
446A	Wire Harness, Internal (4T60E).....				
	(6 Prong Connector w/ 4 Two Prong Conn.) (w/ PWM).....	1	91-93	84446EA	35R-108A
	(7 Prong Connector w/ 2 One Prong Conn.) (w/o PWM).....	1	91-93	84446E	35R-108
	(All 4T60E 94-99).....	1	94-99	84446EC	35R-108B
446A	Wire Harness, Internal (4T65E).....				
	(Universal replaces 14, 17 & 19 Pin Connectors).....	1	97-Up	84446HB	35R-167
	(14 Pin Connector w/o Internal Mode Switch).....	1	97-Up	84446G	35D-167
	(17 Pin Connector).....	1	03-Up	84446HA	35D-167B
	(19 Pin Connector w/ Internal Mode Switch).....	1	00-Up	84446H	35D-167A
HARD PARTS					
Prefix Key: D = OEM, A = Aftermarket New, R = Remanufactured					
PUMPS					
500A	Pump (No Switches) (4T60E).....	1	91-94	84500E	66990C
500A	Pump (No Switches) (4T60E).....	1	95-99	84500ED	66990D
500A	Pump (2 Switches) (4T60E) No Brass Air Bleed).....	1	91-94	84500EB	N/A
500A	Pump, No Pump Rotor Support (4T65E) (Cast # 24206183).....	1	97-02	84500G	66990F
500A	Pump, w/ Pump Rotor Support (4T65E).....	1	02-Up	84500H	66990E
520A	Pump Cover, 13 Bolt.....	1	91-95	84520	66992B
PUMP COMPONENTS					
507K	Pump Cover Sleeve.....	1	91-01	64541	N/A
529F	Converter Reactor (4T60E).....	1	91-99	84529B	66985A
529F	Converter Reactor (4T65E).....	1	97-Up	84529G	66985C
532A	Rotor, Pump (Vane Style) (95-02).....	1	95-02	84532EA	N/A
532A	Rotor, Pump (Bearing Style) (03-Up).....	1	03-Up	84532G	N/A
532A	Rotor Kit, Pump (Vane Style) (95-02).....	1	95-02	84532EAK	N/A
533A	Vane, Pump (17.952mm).....	9-11	91-Up	84533AA	66800
533A	Vane Kit, Pump (17.952mm) (9 Vanes).....	1	91-Up	84533AAK-1	K66800

ELECTRONIC 4 SPEED - FWD

4T60E(M13), 4T65E(MN3, M15, MN7 H.D., M76)

ILL.	DESCRIPTION	QTY.	YEAR	PART NO.	REFERENCE NO.
PUMP COMPONENTS (Cont.)					
533A	Vane Kit, Pump (17.952mm) (11 Vanes)	1	91-Up	84533ABK-1	K66800B
533A	Vane & Ring Kit, Pump (17.952mm).....	1	91-99	84533AAK	N/A
533A	Vane & Ring Kit, Pump (17.970mm).....	1	91-99	84533ABK	N/A
534A	Slide, Pump 17.968mm	1	91-Up	84534AB	66803
535A	Pin, Pivot Slide (No Groove)	1	91-93	84535	66805
535A	Pin, Pivot Slide (w/ Groove).....	1	93-Up	84535A	66805A
538A	Ring, Pump Vane	2	91-Up	84538	66324
DRUMS & CLUTCH HUBS					
552B	2nd Clutch (4T60E) (6 Clutch) (Used w/ Molded Piston)	1	91-99	84552C	66926B
552B	2nd Clutch (4T65E) (25 Degree Splines)	1	97-Up	84552G	N/A
552B	2nd Clutch (4T65E) (10 Degree Splines) (retros 97-Up if used w/ 84624BA)	1	98-Up	84552GA	66926E
552B	2nd Clutch Housing & Shell (4T65E) (Upgrade) (10 Degree Splines)	1	97-Up	84552GAK	K66926E
554H	Forward w/ Input Shaft (4T60E) (Bearing Type)	1	91-E93	84554BA	66999B
554H	Forward w/ Input Shaft (4T60E) (w/ Caged Bearing Inside)	1	L93-99	84554C	66999C
554H	Forward w/ Input Shaft (4T65E) (w/ Caged Bearing Inside)	1	97-Up	84554G	66999E
558D	Reaction Drum w/ Sun Gear 2 3/4" Tall	1	91-95	84558A	66960A
558D	Reaction Drum w/ Sun Gear 3 1/4" Tall	1	96-Up	84558B	66960B
559D	Forward Band Drum (16 Roller Type Sprag).....	1	91-95	84559	66964
559D	Forward Band Drum (14 Roller Type Sprag).....	1	96-Up	84559B	66964A
570G	4th Clutch Hub & Shaft (Bearing at the Clutch Hub End No Sleeve/Race at Splined End)	1	91-E93	84570	N/A
570G	4th Clutch Hub & Shaft (Bearing at the Clutch Hub End Has Sleeve/Race at Splined End)	1	L93-95	84570A	66956
570G	4th Clutch Hub & Shaft (No Bearing at the Clutch Hub End Has Sleeve/Race at Splined End)	1	96-99	84570B	66956B
570G	4th Clutch Hub & Shaft (32 T) (4T65E).....	1	97-Up	84570G	66956E
PLANETS					
582I	Front (w/ Bushing) (4T60E)	1	91-E93	84582AB	66905A
582I	Front (No Bushing) (4T60E)	1	91-99	84582B	66905B
582I	Front (No Bushing) (4T65E) (12 Outer Lugs)	1	97-Up	84582G	66905C
584D	Rear (Inner Splines Beveled on One End Only)	1	91-Up	84584	N/A
584D	Rear (Inner Splines Beveled Both Ends)	1	91-Up	84584A	66955A
<i>(* Final Drive Ring Gears, see Differential Section</i>					
SUN GEARS, SHELLS & SUPPORTS					
612I	Sun Gear, Input (Front)	1	91-E93	84612	66904
612I	Sun Gear, Input (Front) (w/ 2 Flats on Splines, Bearing Type).....	1	L93-Up	84612A	66904N
612I	Sun Gear, Input (Front) (w/ 2 Flats on Splines, No Bearing)	1	96-Up	84612B	66904B
619I	Spacer, Input Sun Gear .350"	1	91-E93	84619A	66945
619I	Spacer, Input Sun Gear .338"	1	L93-99	84619B	66945A
624I	Shell, Reverse Reaction (4T60E) (Hardened)	1	91-99	84624	66978A
624I	Shell, Reverse Reaction (4T65E) (25 Degree Splines)	1	97-Up	84624B	N/A
624I	Shell, Reverse Reaction (4T65E) (10 Degree Splines) (97-Up use w/ 84552GA)	1	98-Up	84624BA	66978B
<i>(* Final Drive Sun Gears, see Differential Section</i>					
SPRAGS					
646C	Sprag Assembly, 3rd/ Low Input (4T60E)	1	91-E93	84646A	K66939A
646C	Sprag Assembly, 3rd/ Low Input (4T60E)	1	L93-99	84646BK	K66939B
646C	Sprag Assembly, 3rd/ Low Input (4T65E) (1 Piece).....	1	97-02	84646BK	K66939B
646C	Sprag Assembly, 3rd/ Low Input (4T65E) (Mechanical Type)	1	03-Up	84646D	66939D
648C	Sprag Assembly, Input (4T65E) (Mechanical Type)	1	03-Up	84648D	66933D
652D	Sprag, 1-2 Roller (16 Rollers).....	1	91-95	44654	35503H
652D	Sprag, 1-2 Roller (14 Roller, Plastic Cage)	1	96-Up	84652A	66974
652D	Accordion Springs, HD., Prevents 1-2 Roller Clutch Failure (16 Per Kit)	1	91-95	84652A-1	K66903
656C	Roller, 3rd Clutch.....	1	91-E93	84656	66939

4T60E, 4T65E

4T60E(M13), 4T65E(MN3, M15, MN7 H.D., M76)

ELECTRONIC 4 SPEED - FWD

ILL.	DESCRIPTION	QTY.	YEAR	PART NO.	REFERENCE NO.
SPRAGS (Cont.)					
658C	Sprag, Low Input.....	1	91-E93	84658A	66933A
658C	Sprag Set, Low Input & 3rd Clutch Double Sprag	1	L93-95	84658BK	66939S
658C	Sprag Set, Low Input & 3rd Clutch Double Sprag	1	96-Up	84658CK	66939T
664D	Inner Race, 1-2 Roller	1	91-95	84664	66973
667C	Outer Race, 3rd Sprag.....	1	91-E93	84667A	N/A
SHAFTS					
671F	Pump Shaft, Oil Pump Drive (9 3/4" Long) (4T60E)	1	91-99	84671	66981
671F	Pump Shaft, Oil Pump Drive (10" Long) (4T65E)	1	97-Up	84671G	66981B
673F	Turbine Shaft (6" Long) (4T60E)	1	91-99	84673A	66930
673F	Turbine Shaft (6 1/4" Long) (4T65E)	1	97-Up	84673G	66930E
674J	Final Drive Sun Gear Shaft (6 1/4" Long)	1	91-Up	84674B	66934A
678I	Output Shaft (17 3/4") (Uses a 3/4" Long # 241 Bearing) (4T60E).....	1	91-E93	84678C	N/A
678I	Output Shaft (19 1/2") (Uses a 3/4" Long # 241 Bearing) (4T60E).....	1	91-E93	84678D	66906B
678I	Output Shaft (19 1/2") (No Bearing Under 4th Clutch Hub) (4T60E)	1	L93-99	84678E	66906D
678I	Output Shaft (19 1/2") (w/ Bearing Under 4th Clutch Hub) (4T60E) Turbo	1	96-99	84678G	66906F
678I	Output Shaft (4T65E)	1	97-Up	84678H	66906J
CHAINS					
700F	Chain (4T60E) (Round Pin 7/8" Wide).....	1	91-93	84700A	51973A
700F	Chain (4T60E) (Exc Round Pins) (Replaces Rocker Joint Pins & D Pins).....	1	93-99	14700B	86973B
700F	Chain (4T65E) (w/ Mouse Ear Link & D Pins) (1/2" Wide) (Dual Chains).....	1	97-Up	84700G	51973E
700F	Chain (4T65E) (Racing) (1" Wide).....	1	97-Up	84700H	51973H
702B	Scoop, Chain Scavenging (2nd Design) (For 33 T Sprocket)	1	91-Up	84702B	N/A
702B	Scoop, Chain Scavenging (2nd Design) (For 35 T Sprocket)	1	91-Up	84702C	N/A
SPROCKETS SETS					
705F	Sprocket Set, w/ Shaft (35 Drive & 35 Driven) (Rocker Pin)	1	93-Up	84710FK	K66977B
705F	Sprocket Set, w/ Shaft (37 Drive & 33 Driven) (Round Pin)	1	91-92	84710CK	K66977A
705F	Sprocket Set, w/ Shaft (37 Drive & 33 Driven) (Rocker Pin)	1	93-Up	84710CAK	K66977C
705F	Chain & Sprocket Set, Gemini Design (33 Drive & 37 Driven) (4T65E)	1	97-Up	84710GAK	K66977J
705F	Chain & Sprocket Set, Gemini Design (35 Drive & 35 Driven) (4T65E)	1	97-Up	84710GK	K66977H
705F	Chain & Sprocket Set, Gemini Design (37 Drive & 33 Driven) (4T65E)	1	97-Up	84710GBK	K66977G
713B	Support, Driven Sprocket (4T60E).....	1	1991	84713B	N/A
713B	Support, Driven Sprocket (4T60E).....	1	92-99	84713C	66949B
713B	Support, Driven Sprocket (1st Design Sealing Ring) (4T65E)	1	97-E98	84713G	66949C
713B	Support, Driven Sprocket (2nd Design Sealing Ring) (4T65E)	1	L98-Up	84713H	66949F
DIFFERENTIAL SECTION					
715J	Final Dr Kit, 2.86/2.84 Ratio (w/ Reluctor) Bushing Type	1	91-95	84715CAK	N/A
715J	Final Dr Kit, 2.86/2.84 Ratio (w/ Reluctor) Bushing Type	1	96-Up	84715CEK	66972L
715J	Final Dr Kit, 3.05/3.06 Ratio (w/ Reluctor) Bushing Type	1	91-95	84715AAK	N/A
715J	Final Dr Kit, 3.05/3.06 Ratio (w/ Reluctor) Bushing Type	1	96-Up	84715AEK	66972M
715J	Final Dr Kit, 3.29/3.33 Ratio (w/ Reluctor) Bushing Type	1	91-95	84715BAK	N/A
715J	Final Dr Kit, 3.29/3.33 Ratio (w/ Reluctor) Bushing Type	1	96-Up	84715BEK	66972N
715J	Final Dr Kit, 3.29/3.33 Ratio (w/ Reluctor) Bearing Type (MN7)	1	96-Up	84715DEK	66972S
715J	Final Dr Kit, 3.05 Only Ratio (w/ Reluctor) Bearing Type (MN7) Fine Pitch, HD Carrier	1	96-Up	84715DGK	66972R
715J	Carrier, 30T Sun Gr, 3.33 Ratio, Std Pitch, 2.945 Journal (w/o Reluctor)	1	91-Up	84715CG	66972K
715J	Carrier, 34T Sun Gr, 3.06 Ratio, Std Pitch, 2.945 Journal (w/o Reluctor)	1	91-Up	84715BB	66972J
715J	Carrier, 38T Sun Gr, 2.84 Ratio, Std Pitch, 2.945 Journal (w/o Reluctor)	1	91-Up	84715AC	66972H
598J	Ring Gear, Final Drive (70 Right Angled Teeth)	1	91-95	84598A	66935A
598J	Ring Gear, Final Drive (70 Right Angled Teeth)	1	96-Up	84598C	66935C
598J	Ring Gear, Final Drive (70 Left Angled Teeth)	1	L93-95	84598B	66935B
598J	Ring Gear, Final Drive (78 Left Angled Teeth)	1	96-99	84598D	66935D

ELECTRONIC 4 SPEED - FWD

4T60E(M13), 4T65E(MN3, M15, MN7 H.D., M76)

ILL.	DESCRIPTION	QTY.	YEAR	PART NO.	REFERENCE NO.
DIFFERENTIAL SECTION (Cont.)					
618J	Sun Gear, Final Drive 30 T (Right Angled Teeth)	1	91-95	84618B	51955B
618J	Sun Gear, Final Drive 34 T (Left Angled Teeth).....	1	91-Up	84618AA	N/A
618J	Sun Gear, Final Drive 34 T (Right Angled Teeth)	1	91-95	84618A	51955A
618J	Sun Gear, Final Drive 34 T (Right Angled Teeth)	1	96-99	84618C	N/A
618J	Sun Gear, Final Drive 38 T (Right Angled Teeth)	1	91-95	84618	51955
618J	Sun Gear, Final Drive 38 T (Right Angled Teeth)	1	96-99	84618CA	N/A
618J	Sun Gear, Final Drive 42 T (4T60E) (Fine Tooth Pitch)	1	91-95	84618E	N/A
618J	Sun Gear, Final Drive 42 T (4T60E) (Fine Tooth Pitch)	1	96-99	84618CB	N/A
618J	Sun Gear, Final Drive 42 T (4T65E) (Fine Tooth Pitch)	1	97-Up	84618E	N/A
477	Reluctor, Final Drive Carrier (30 T)	1	91-Up	84477	66988A
477	Reluctor, Final Drive Carrier (31 T)	1	91-Up	84477A	66988C
477	Reluctor, Input (3 Mounts to Drive Sprocket) (25 T)	1	91-Up	84477B	66989
717	Washer, Differential Side Gear.....	1	83-92	84717-1	66418A
VALVE BODIES					
740A	Valve Body (Premium) (4T60E)	1	91-92	84740-4	P66991E
740A	Valve Body (Premium) (4T60E)	1	93-99	84740-1	P66991F
740A	Valve Body (Premium) (4T65E) (Holley Solenoid, 2 piece Pump Type) (Exc Volvo)	1	97-02	84740-2	P66991H
740A	Valve Body (Premium) (4T65E) (Holley Solenoid, 3 piece Pump Type) (Exc Volvo)	1	2002	84740-5	P66991K
740A	Valve Body (Premium) (4T65E) (Bosch Solenoid, 2 piece Pump Type) (Exc Volvo).....	1	2003	84740-6	P66991J
740A	Valve Body (Premium) (4T65E) (Bosch Solenoid, 3 piece Pump Type) (Exc Volvo).....	1	2003	84740-3	P66991L
740A	Valve Body (Premium) (4T65E) (Volvo)	1	99-02	84740-7	P66991V
740A	Valve Body (Premium) (4T65E) (Volvo & GM Tap Shift Type)	1	04-Up	84740-8	P84740-8
740A	Valve Body (Premium) (4T65E) (GM Non Tap Shift Type)	1	04-Up	84740-3	P66991L
VALVE BODY COMPONENTS					
741K	Boost Valve Kit, Modulated Line High Ratio (4T60E).....	1	91-99	84741MA-1	K66822D
741K	Boost Valve Kit, Modulated Line Low Ratio (4T60E).....	1	91-99	84741M-1	K66822C
741K	Boost Valve Kit, Reverse & Modulated Line (4T60E).....	1	91-99	84741MAK	K66822H
741K	Boost Valve Kit, Reverse & Modulated Line Low Ratio (4T60E)	1	91-99	84741MK	K66822L
741K	Boost Valve Kit, Reverse High Ratio (4T60E).....	1	91-99	84741RAK-1	K66822K
741K	Boost Valve Kit, Reverse Low Ratio (4T60E).....	1	91-99	84741RK-1	K66822J
741K	Boost Valve Kit (4T65E)	1	91-99	84741F	K66831
741K	E-Ring Retainer, Boost Sleeve (Bag of 10) (4T60E).....	1	91-99	84741-4G	66836
741K	Kit, 1-2 & Reverse Servo Boost Valve (4T60E) (requires T-84754-TL2)	1	91-99	84741GK	K66828
741K	Lock-Up Sleeve, Input & 3rd Clutch	1	91-99	84741C-2	66932
741K	Retainer Pin, Servo Boost Sleeve (Bag of 10) (4T60E)	1	91-99	84741-4A	66838
741K	Retainer, Boost Sleeve (Bag of 10) (4T60E)	1	91-99	84741-4B	66837
741K	Spring, Anti-Shutter (4T60E)	1	91-99	84741CE-3	N/A
741K	Sleeve, ISO Valve (requires T-84754-TL6).....	1	93-99	84741Q-1	66970S
741K	T.V. Plunger (.396" Steel) (4T60E)	1	91-99	84741NA-4	66971
741K	TCC Regulator & Isolator Valve Kit, PWM (requires T-84754-RM)	1	91-92	84741CAK	K66970A
741K	TCC Regulator Valve Kit (Eliminates Code 740).....	1	93-99	84741CK	K66970
741K	Valve Body Clip (Bag of 10) (4T60E)	1	91-99	84741-4F	66835
741K	Valve, 1-2 Shift (4T60E).....	1	91-99	84741SD-1	66823V
741K	Valve, 2-3 Shift (Anodized) (4T60E)	1	91-99	84741SB-1	66824V
741K	Valve, 3-2 Downshift (Anodized) (4T60E).....	1	91-99	84741S-1	66826V
741K	Valve, 3-4 Shift (Anodized) (4T60E)	1	91-99	84741SA-1	66825V
741K	Valve, 4-3 Downshift (Anodized) (4T60E)	1	91-99	84741SC-1	66827V
741K	Valve Kit, AFL Valve & Sleeve (4T65E) (requires T-F-84596-TL)	1	97-Up	84741LK	K66842
741K	Valve, TCC Apply O.S. (Codes 39, 740 & 1870) (4T60E) (requires T-84754-TL5 & -DJ2)	1	91-99	84741CC-1	66972BV
741K	Valve, TCC Apply O.S. (Codes 740 & 1870) (4T60E) (requires T-84754-TL).....	1	91-99	84741CA-1	66972V
741K	Valve, TCC Apply OEM (Codes 39, 740 & 1870) (4T60E)	1	91-99	84741CB-1	66972CV
741K	Valve, TCC Apply Standard (4T60E).....	1	91-99	84741C-1	66972AV
741K	Valve, TCC Apply w/ Teflon Seal (4T65E).....	1	97-Up	84741CD-1	K66833
741K	Valve Kit, TCC Regulated Apply (4T65E)	1	97-Up	84741QK	K66832

4T60E, 4T65E

4T60E(M13), 4T65E(MN3, M15, MN7 H.D., M76)

ELECTRONIC 4 SPEED - FWD

ILL.	DESCRIPTION	QTY.	YEAR	PART NO.	REFERENCE NO.
CHANNEL PLATES					
746E	Plate, Accumulator Cover to Case.....	1	91-99	84746A	N/A
755A	Channel Plate (4T60E) (Cast # Varies).....	1	91-92	84755H	66995E
755A	Channel Plate (4T60E) (Cast # 217) (No Switch).....	1	93-94	84755HA	66995F
755A	Channel Plate (4T60E) (Cast # 656) (Has Pan Bolt Studs).....	1	1994	84755JA	N/A
755A	Channel Plate (4T60E) (Cast # 656) (No Studs) (No TCC Piston).....	1	91-99	84755JE	N/A
755A	Channel Plate (4T60E) (Cast # 657) (No Studs) (No TCC Piston).....	1	91-99	84755JB	N/A
755A	Channel Plate (4T60E) (Cast # 657) (No Studs) (w/ TCC Piston).....	1	91-99	84755JC	N/A
755A	Channel Plate (4T60E) (Cast # 760).....	1	91-99	84755L	66995C
755A	Channel Plate (4T65E) (Cast # 479) w/ Axle Stabilizer Bore.....	1	97-Up	84755P	66995K
755A	Sleeve, Channel Plate (Presses In Channel Plate) (4T60E).....	1	91-99	84755S	66641
755A	Sleeve, Channel Plate (Presses In Channel Plate) (4T65E).....	1	97-Up	A84755SA	66641B
755A	Relief Valve, TCC Apply (Bag of 10) (4T65E).....	1	97-Up	84755A-1	66839
CASES & HOUSINGS					
760E	Case (4T60E) (Square Top Bell).....	1	91-99	84760C	N/A
760E	Case (4T60E) (Round Bell).....	1	91-99	84760CB	N/A
760E	Case (4T65E).....	1	97-Up	84760D	N/A
765K	Pan, Bottom (4T60E).....	1	91-99	84765A	N/A
765K	Pan, Bottom (4T65E).....	1	97-Up	84765B	N/A
766A	Pan, Side Cover (4T60E) (Aluminum) (w/ 4 Threaded Holes).....	1	91-99	84766B	N/A
766A	Pan, Side Cover (4T60E) (Aluminum) (w/ 6 Threaded Holes).....	1	91-99	84766BA	N/A
766K	Pan, Side Cover (4T65E).....	1	97-Up	84766C	66984
770E	Extension Housing (4T60E).....	1	91-99	84770	N/A
770E	Extension Housing (4T65E) w/ Bearing to Final Drive.....	1	97-Up	84770D	N/A
MISCELLANEOUS COMPONENTS					
683J	Pick-Up, Speed Sensor (29 T).....	1	97-Up	84683AC	N/A
683J	Pick-Up, Speed Sensor (30 T).....	1	91-Up	84683AA	66988A
683J	Pick-Up, Speed Sensor (31 T).....	1	91-Up	84683AB	66988C
686E	Cover (Electronic Speed-O Type) (4T60E).....	1	91-99	84686C	N/A
690J	Gear, Parking.....	1	91-Up	84690	66986
698D	Oil Dam, Front Planet.....	1	91-Up	84698	66910
699A	Weir, Oil Reservoir.....	1	91-Up	84699A	N/A
874	Snap Ring, Holds Pinion Pins In Differential Housing (Spiral).....	1	91-Up	76874A	53962S
895I	Snap Ring, Output Shaft to Differential.....	1	91-Up	84895	N/A
900K	Servo Assembly, Manual 2-1 (Forward).....	1	91-Up	84900	N/A
907E	Servo & Sleeve, 1-2 / Reverse.....	1	91-Up	84907AK	K66983
908E	Pin, 1-2 Servo (3.680") (4T60E).....	1	91-Up	84908H	66707F
909E	Cover, Forward Servo (4T60E).....	1	91-99	84909B	N/A
910E	Servo Assembly, Reverse (Cover is 3/4" Overall Thick) (4T65E).....	1	97-Up	84910G	N/A
912E	Piston, Reverse Servo.....	1	91-99	84912	N/A
914E	Cover, Reverse Servo (3 Bolt Type).....	1	91-99	84914A	N/A
926E	Spring, 1-2 Accumulator (Orange/Green).....	1	91-99	84926	66706
926E	Spring, 1-2 Accumulator (Plain Colored).....	1	91-99	84926B	N/A
927E	Piston, 1-2 Accumulator Deep Design (w/o Spring Recess) (Aluminum).....	1	91-99	84927	66993
927E	Piston, 1-2 Accumulator Deep Design (w/o Spring Recess) (Aluminum Replacement).....	1	91-99	A84927	N/A
927E	Piston, 1-2 Accumulator Deep Design (w/ Spring Recess) (Aluminum w/ O-Ring).....	1	97-99	84927C	66993B
927E	Piston, 1-2 Accumulator Deep Design (w/ Spring Recess) (Aluminum Replacement).....	1	97-Up	A84927D	6993K
927E	Piston, 1-2 Accumulator Shallow Design (Use 84927C) (4T60E).....	1	91-99	84927B	66993A
927E	Piston Kit, 1-2, 3-4 (2 Pistons, 1 Spring, 1 Spacer) Transgo (4T60E).....	1	91-99	A84927EK	K66993
928E	Pin, 1-2 & 2-3 Accumulator (4T60E).....	1	91-99	84928	66994
928E	Pin, 1-2 & 2-3 Accumulator (4T65E).....	1	97-Up	84928A	66994D
928E	Pin, Oversized Accumulator Allows Re-use of Worn Piston.....	1	91-99	84928X	66994P
928E	Pin & Reamer Kit, Includes OS Pin & Reamer for Boring Original Piston.....	1	91-99	84928XK	T-9149
929E	Cover, 1-2 & 2-3 Accumulator (Cast # 24203536) (4T65E).....	1	97-Up	84929G	N/A

**ELECTRONIC
4 SPEED - FWD**

**4T60E(M13),
4T65E(MN3, M15, MN7 H.D., M76)**

ILL.	DESCRIPTION	QTY.	YEAR	PART NO.	REFERENCE NO.
MISCELLANEOUS COMPONENTS (Cont.)					
934E	Accumulator Cover (4T60E)	1	91-99	84934B	N/A
934E	Accumulator Cover, w/ Tubes (Cast # 8651533) (4T60E)	1	91-99	84934A	N/A
934E	Accumulator Cover, w/ Tubes (Cast # 4X00317) (4T65E)	1	97-Up	84934G	N/A
935F	Accumulator Assembly, 3-4 (w/ 2" Tall Cover) (4T60E)	1	91-99	84935	N/A
935F	Accumulator Assembly, 3-4 (w/ 1 3/4" Tall Cover) (4T65E)	1	97-Up	84935G	N/A
936A	Spring, Middle Input For 3-4 Accumulator	1	91-Up	84936A	N/A
936A	Spring, Outer Input For 3-4 Accumulator	1	91-Up	84936B	N/A
936A	Spring, Inner Input For 3-4 Accumulator (Green/ Violet)	1	91-Up	84936C	N/A
936A	Spring, Inner Input For 3-4 Accumulator (Pink)	1	91-Up	84936R	N/A
936A	Spring, Inner Input For 2-3 Accumulator	1	91-99	84936RA	N/A
937A	Piston, 3-4 Accumulator Deep Design (w/o Spring Recess) (Aluminum)	1	91-99	84927	66993
937A	Piston, 3-4 Accumulator Deep Design (w/o Spring Recess) (Aluminum Replacement)	1	91-99	A84927	N/A
937A	Piston, 3-4 Accumulator Deep Design (w/ Spring Recess) (Aluminum w/ O-Ring).....	1	97-99	84927C	66993B
937A	Piston, 3-4 Accumulator Deep Design (w/ Spring Recess) (Aluminum Replacement) .	1	97-Up	A84927D	N/A
937A	Piston Kit, 3-4 (2 Pistons, 1 Spring, 1 Spacer) Transgo.....	1	91-99	A84927EK	K66993
937A	Piston, 3-4 Accumulator (Aluminum) (4T65E)	1	97-Up	D84937A	D66993K
937A	Piston, 3-4 Accumulator (Aluminum Replacement) (4T65E)	1	97-Up	A84927D	66993K
938A	Pin, Input or 3-4 Accumulator (1 3/4" Long).....	1	91-Up	84938	66994J
939F	Canister, 3-4 Accumulator Piston (2" Tall)	1	91-99	84939	N/A
941A	Spring, Converter Clutch Accumulator	1	91-99	84941	N/A
942A	Piston, Converter Clutch Accumulator	1	91-99	84942A	N/A
943A	Pin, Converter Clutch Accumulator.....	1	91-99	84943	N/A
961G	Piston, 4th Clutch (4T65E)	1	97-Up	84961	N/A
962B	Piston, 2nd Clutch Drum (Bonded) (5 1/8" OD) (4T60E).....	1	91-99	84962E	66929A
962B	Piston, 2nd Clutch Drum (5 3/8" OD) (Molded Rubber) (4T65E)	1	97-Up	84962G	66929B
964H	Piston, Input Clutch (8 Clutches on 3rd Clutch).....	1	91-Up	84964	N/A
964H	Piston, Input Clutch (10 Clutches on 3rd Clutch).....	1	91-Up	84964B	66934
965H	Piston, 3rd Clutch w/ Molded Rubber (w/ Check Ball) (4T60E).....	1	91-99	84965A	66917A
965H	Piston, 3rd Clutch w/ Molded Rubber (No Ck Ball) (4T65E).....	1	97-Up	84965G	66917B
971G	Springs w/ Retainer, 4th Clutch (3 3/8" ID) (4T60E).....	1	91-95	84971	66931
971G	Springs w/ Retainer, 4th Clutch (3 5/8" ID) (4T65E)	1	97-Up	84971G	N/A
972B	Spring w/ Retainer, 2nd Clutch (13/16" Tall) (4T60E)	1	91-99	84972B	66921A
972B	Spring w/ Retainer, 2nd Clutch (1 7/16" Tall) (4T65E)	1	97-Up	84972G	N/A
974H	Spring & Retainer, Input Clutch (16 Springs) (4T60E).....	1	91-95	84974	66923
974H	Spring & Retainer, Input Clutch (14 Springs) (4T65E).....	1	97-Up	84974G	N/A
975H	Guide w/ Spring Retainer, 3rd Clutch (12 Springs)	1	91-95	84975	66924
980	Spacer, 1-2 Sprag to Drum.....	1	91-99	84980	N/A
985H	Housing, 3rd Clutch (Takes Molded Piston) (No Check Ball) (4T60E)	1	91-95	84985A	N/A
985H	Housing,3rd Clutch (w/ Check Ball) (4T65E).....	1	97-Up	84985G	N/A
989	Retainer, Input Sprag Clutch (Late)	1	91-93	84989A	66925
991K	Rooster Comb Kit, w/ Link & Spring	1	91-99	84991E-3K	66957
992	Manual Shaft, Goes Thru Case	1	91-99	84992B	N/A
994	Park Rod.....	1	91-Up	84994C	N/A
996	Cooler Line Fitting (w/ Check Ball) (Flared)	1	91-99	84996AA	96-440
996	Cooler Line Fitting (w/ Check Ball) (Push In)	1	00-Up	74996A	96-440B
996	Connector, Cooler Line to Case (1 Req.) (4T65E).....	1	00-Up	74996B	96-460
999K	Retainer, Differential Lube Tube.....	1	91-Up	84999-5	66890

4T60E, 4T65E

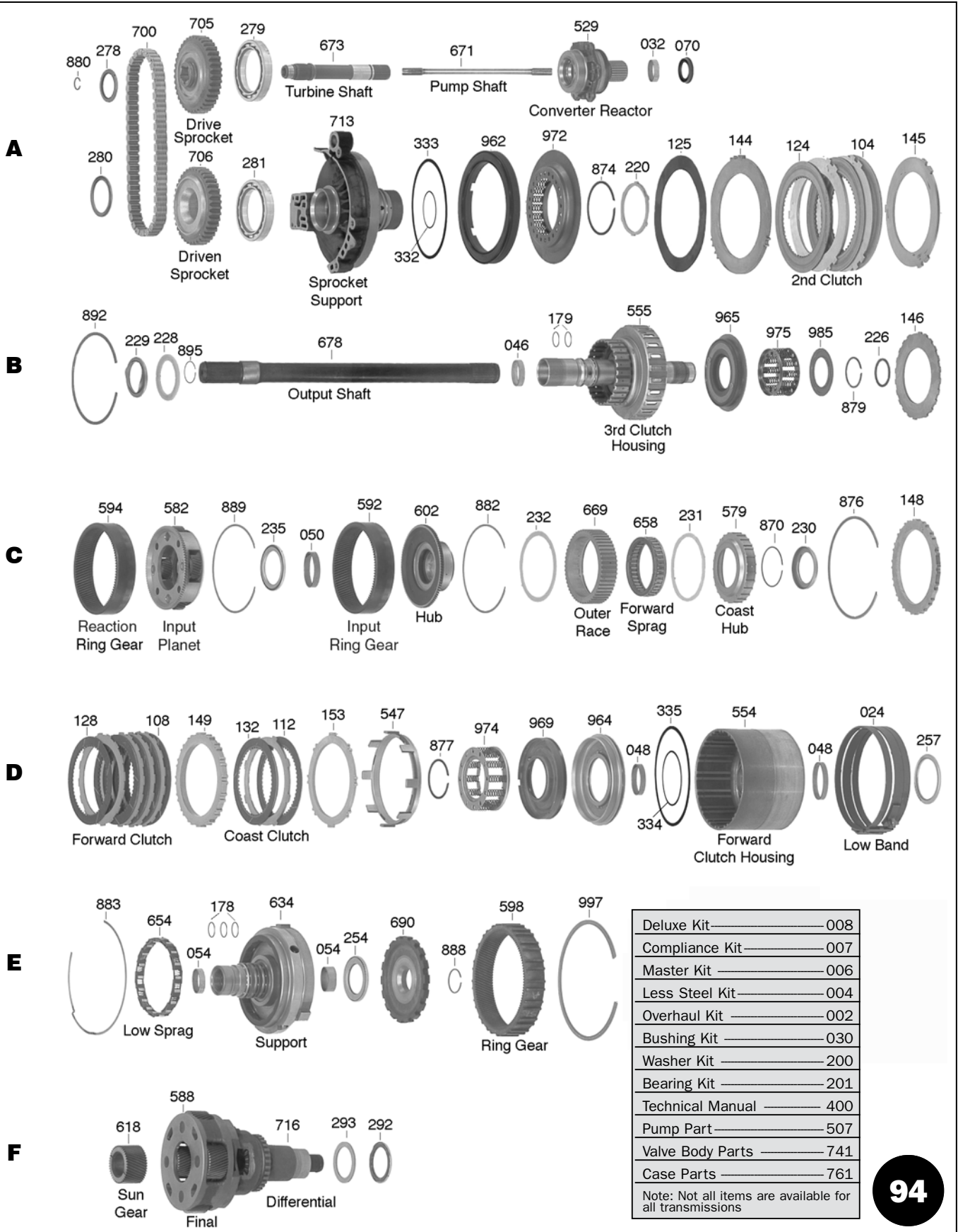

4 SPEED FWD

4T80E (MH1) ELECTRONIC

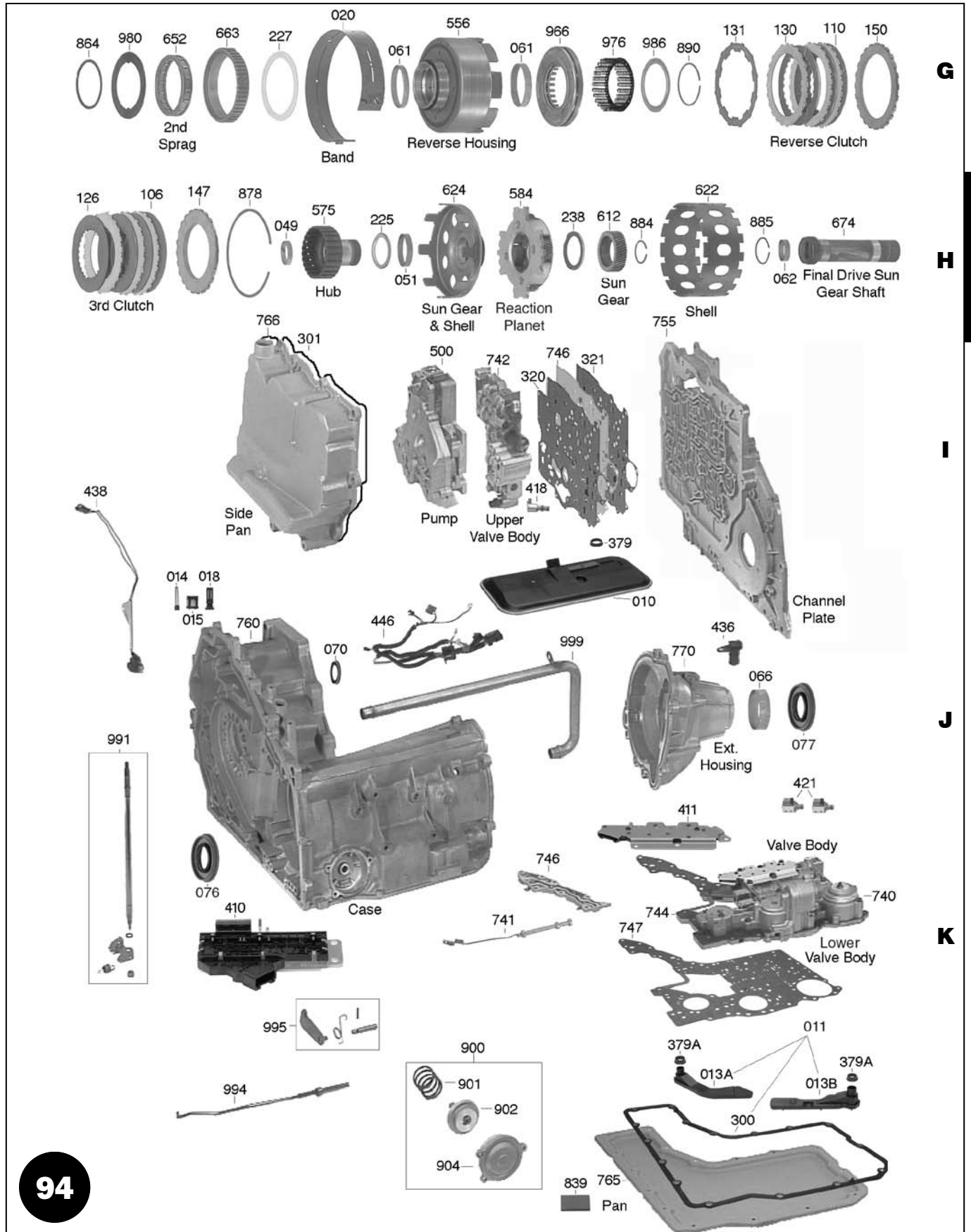

4T80E (MH1) ELECTRONIC

4 SPEED FWD



Under Side Cover
94010A

1993-Up
General Motors
Cadillac :
Allante
Seville STS
Eldorado

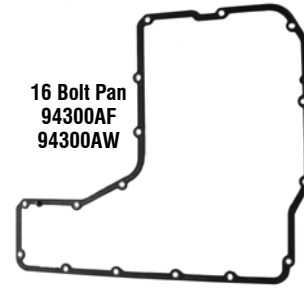

16 Bolt Pan
94300AF
94300AW



Left Scavenger
94013A



Right Scavenger
94013B

ILL.	DESCRIPTION	QTY.	YEAR	PART NO.	REFERENCE NO.
DELUXE KITS (SUPER KITS)					
008E	4T80E (Bonded Gasket)	1	93-94	94008AW	K8300-R
008E	4T80E (Bonded Gasket) (03-Up, purchase VB Separator Plates 94322D).....	1	95-Up	94008BW	K8300A-R
COMPLIANCE KITS (CALIFORNIA KITS)					
007E	4T80E (Bonded Gasket)	1	93-94	94007AW	N/A
007E	4T80E (Bonded Gasket) (03-Up, purchase VB Separator Plates 94322D).....	1	95-Up	94007BW	N/A
MASTER OVERHAUL KITS (WITH STEELS)					
006E	4T80E (Bonded Gasket)	1	93-94	94006AW	K8300
006E	4T80E (Bonded Gasket) (03-Up, purchase VB Separator Plates 94322D).....	1	95-Up	94006BW	K8300A
LESS STEEL KITS					
004E	4T80E (Bonded Gasket)	1	93-94	94004AW	K8300-LS
004E	4T80E (Bonded Gasket) (03-Up, purchase VB Separator Plates 94322D).....	1	95-Up	94004BW	K8300A-LS
OVERHAUL KITS (W/ RINGS & SEALS)					
002E	4T80E (Bonded Gasket) (03-Up, purchase VB Separator Plates 94322D).....	1	93-Up	94002AW	K83900
002E	4T80E (Bonded Gasket) (w/o Bonded VB Separator Plates)	1	93-Up	94002CW	K83900H
FILTER KITS					
011	Filter Kit - Includes L & R Scavenger Filters & Pan Gasket	1	93-Up	94011	FK83801
FILTERS					
010I	Under Side Cover	1	93-Up	94010A	83800
013K	Left Scavenger.....	1	93-Up	94013A	83801
013K	Right Scavenger.....	1	93-Up	94013B	83802
014J	Pump Pressure Screen (in Valve Body).....	1	93-Up	74014A	61711
015J	EPC Solenoid (in Valve Body)	1	93-Up	34018	34713B
018J	Shift Solenoid (in Valve Body between 2 Shift Solenoids).....	1	93-Up	94018A	83712B
BANDS					
Prefix Key: B = Borg Warner, A = OEM (Exc BW), N = All Other New, R = Relined					
020G	Overdrive (Front, Flex)	1	93-Up	94020A	83700
024D	Low/ Reverse (Double Wrap).....	1	93-Up	94024A	83701
BUSHINGS					
030E	Bushing Kit	1	93-Up	94030A	K83901
034	Bushing, Converter	1	93-Up	94034	83001

ILL.	DESCRIPTION	QTY.	YEAR	PART NO.	REFERENCE NO.
METAL CLAD SEALS					
070J	Front Converter Housing.....	1	93-Up	94070A	83200
071	Turbine Shaft in Channel Plate (Double Lip)	1	93-Up	94071	83206
072	Manual Shaft.....	1	93-Up	84072A	51202A
076J	Right Axle	1	93-Up	94076A	83201
077J	Left Axle	1	93-Up	94077A	83201A
080	Drive Sprocket (In Channel Plate) (Teflon Lip)	1	93-Up	94080	83205
081	Seal, Rear Sun Gear	1	93-Up	94081	83207
FRICITION PLATES					
104A	2nd Clutch (.081")	3-4	93-94	94104A	83100
104A	2nd Clutch (.071")	4	95-Up	94104B	83100A
106H	3rd Clutch.....	4	93-Up	94106A	83104
108D	Forward	5	93-Up	94108A	83106
110G	Reverse	3	93-Up	94110A	83103
112D	Coast (51 T)	2	93-94	94112A	83108
112D	Coast (53 T)	2	95-Up	94112B	83108A
STEEL PLATES					
124A	2nd Clutch (.091")	2-3	93-94	94124A	83101
124A	2nd Clutch (.081")	3	95-Up	94124B	83101A
126H	3rd Clutch.....	3	93-Up	94126A	83105
128D	Forward	4	93-Up	94128A	83107
130G	Reverse	3	93-Up	94130A	83102
131G	Reverse (Cushion - Waved).....	1	98-Up	94131	83714N
132D	Coast.....	1	93-Up	94132A	83109
PRESSURE PLATES					
Prefix Key: D = OEM, A = New Aftermarket, R = Remanufactured					
144A	2nd Clutch (Apply) Flat (.175")	1	1994	94144C	83714H
144A	2nd Clutch (Apply) Flat (.205")	1	1994	94144B	83714K
144A	2nd Clutch (Apply) Stepped (.185")	1	1993	94144A	83714
145A	2nd Clutch (Backing) Flat (.175").....	1	95-Up	94145A	83714A
145A	2nd Clutch (Backing) Flat (.235").....	1	1994	94145AA	83714L
145A	2nd Clutch (Backing) Stepped (.270")	1	95-Up	94145B	83714J
146B	3rd Clutch (Apply) Flat	1	93-Up	94146A	83714C
147H	3rd Clutch (Backing) Stepped.....	1	93-Up	94147A	83714D
148C	Forward Clutch (Apply)	1	93-Up	94148A	N/A
149D	Forward (Apply) (.435")	1	94-Up	94149A	83714G
149D	Forward (Backing) (7.2mm)	1	93-Up	94149B	83716
149D	Forward (Backing) (7.5mm)	1	93-Up	94149C	83716A
149D	Forward (Backing) (7.8mm)	1	93-Up	94149CA	83716B
149D	Forward (Backing) (8.0mm)	1	93-Up	94149D	83716C
149D	Forward (Backing) (8.3mm).....	1	93-Up	94149E	83716D
149D	Forward (Backing) (8.5mm)	1	93-Up	94149EA	83716E
149D	Forward (Backing) (9.0mm)	1	93-Up	94149F	83716G
149D	Forward (Backing) (9.3mm)	1	93-Up	94149H	83716H
150G	Reverse (Apply) (.200") (5.0mm).....	1	93-98	94150	83715B
150G	Reverse (Apply) (.230") (5.7mm).....	1	98-Up	94150A	83714B
150G	Reverse (Backing) (4.4mm)	1	93-98	94150B	83715
150G	Reverse (Backing) (4.9mm)	1	93-98	94150C	83715A
150G	Reverse (Backing) (5.0mm)	1	93-98	94150	83715B
150G	Reverse (Backing) (5.2mm)	1	98-Up	94150D	83715E
150G	Reverse (Backing) (6.0mm)	1	98-Up	94150E	83715F
153D	Coast Clutch (Apply) (.210").....	1	93-Up	94153	83714E
153D	Coast Clutch (Backing) (.435").....	1	93-Up	94149A	83714G

ILL.	DESCRIPTION	QTY.	YEAR	PART NO.	REFERENCE NO.
SEALING RINGS					
175E	Ring Kit.....	1	93-Up	94175A	K83903
THRUST WASHERS					
200E	Washer Kit	1	93-Up	94200	K83400
220A	2nd Clutch	1	93-Up	94220	83402
226B	3rd Clutch Hub.....	1	93-Up	94226	83405
227G	Reverse Drum to Sprag Race	1	93-Up	94227	83403
228B	Driven Sprocket Support to 3rd Drum (3.01mm)	1	93-Up	94228C	83404B
228B	Driven Sprocket Support to 3rd Drum (3.82mm)	1	93-Up	94228F	83404E
228B	Driven Sprocket Support to 3rd Drum (4.75mm)	1	93-Up	94228K	83404H
BEARINGS					
235C	Front Planet & Front Planet to Hub	2	93-Up	44211C	35400C
254E	Fwd Drum Support to Park Gear.....	1	93-Up	84238	66502
278A	Drive Sprocket	1	93-Up	44211C	35400C
292F	Differential Case.....	1	93-Up	44211C	35400C
GASKETS & O-RINGS					
300K	Gasket, Bottom Pan (Fiber).....	1	93-Up	94300AF	13929F
300K	Gasket, Bottom Pan (Bonded)	1	93-Up	94300AW	13929R
301I	Gasket, Side Cover (Bonded).....	1	93-Up	94301W	13932
310	Gasket, Pump to Spacer (Secondary).....	1	93-Up	94310A	N/A
320I	Gasket, Valve Body Plate to Case.....	1	93-Up	94320A	N/A
N.I.	Gasket Kit, Cover, Valve Body & Spacer	1	93-Up	94320CK	K13931
322I	Gasket, VB w/ Separator (1993 w/ FV3 & FV4)	1	1993	94322A	13512
320I	Gasket, VB w/ Separator (Stamp # 1193, Code FV4 Only).....	1	1994	94322B	13512A
320I	Gasket, VB w/ Separator (Stamp # 5347 or 3957 & 94 FV3).....	1	94-03	94322C	13512B
320I	Gasket, VB w/ Separator (Stamp # 5286)	1	03-Up	94322D	13512C
321I	Gasket, Valve Body to Valve Body Plate	1	93-Up	94321A	N/A
324	Gasket, Channel Plate (Outer)	1	93-Up	94324A	13933
325	Gasket, Channel Plate (Inner)	1	93-94	94325A	13937
325	Gasket, Channel Plate (Inner)	1	95-Up	94325B	13937A
348	Seal, Extension Housing to Case.....	1	93-Up	94348	13934
379I	Seal, Oil Filter	1	93-Up	94379	13949
379K	Seal, Scavenger Filters	2	93-Up	94379A	13950
TECHNICAL MANUALS					
400E	Tech Manual	1	93-Up	94400	83Y01
400E	Tech Manual, GM Transmission Guide	1	93-Up	94400A	N/A
ELECTRICAL COMPONENTS					
410K	Switch, Internal Mode (Manual Valve).....	1	00-Up	94410	15D-328
411J	Manifold Pressure Switch & Range Sensor (PRNDL Switch)	1	93-99	94411A	15D-136
411J	Manifold Pressure Switch (Internal Mode Design)	1	00-04	94411B	15D-136A
425	Solenoid, Lock-Up (TCC) PWM	1	93-Up	74418E	5B-187
421J	Solenoid Kit, Shift (1-2, 2-3) (w/ Both Solenoids & Bracket) (Will Retro) (2-3 to 99) ..	1	93-Up	94421AK	5D-171K
421J	Solenoid, 1-2 Shift	1	93-Up	94421A	5D-171A
421J	Solenoid, 2-3 Shift	1	93-99	94421A	5D-171A
421J	Solenoid, 2-3 Shift (Internal Mode Design)	1	00-Up	94421B	5D-171B
431	Solenoid, EPC (2 Prong Connector at the Bottom) (Spade Terminal).....	1	93-03	34435A	5D-152A
431	Solenoid, EPC (2 Prong Connector at the Side) (Molded Connector).....	1	04-Up	34435C	5D-152C
N.I.	Repair Kit, EPC Solenoid (Refill) w/o Tool Kits (Transgo) 4 Repairs.....	1	93-Up	T34435ARK	4L6-SOL-4
N.I.	Repair Kit, EPC Solenoid w/ Tool Kits (Transgo) 4 Repairs.....	1	93-Up	T34435RK	5A-152K
436J	Sensor, Vehicle Output Speed Sensor (VSS)	1	93-Up	94436A	20D-108
437	Sensor, Temperature.....	1	93-Up	94437A	20D-106

ILL.	DESCRIPTION	QTY.	YEAR	PART NO.	REFERENCE NO.
ELECTRICAL COMPONENTS (Cont.)					
438J	Sensor, Input Speed (TSS) (1st Design Flat Bracket)	1	93-E96	94438A	20D-107
438J	Sensor, Input Speed (TSS) (2nd Design Bracket w/ Dimple)	1	L96-Up	94438AA	20D-107A
446J	Wire Harness, Dual Plug (6 & 8 Pin Connectors) (1.550" OD)	1	1993	94446A	35D-101
446J	Wire Harness, Single Plug (14 Pin Connector) (1.550" OD)	1	94-E96	94446B	35D-101A
446J	Wire Harness, Single Plug (14 Pin Connector) (1.425" OD)	1	L96-01	94446C	35D-101B
446J	Wire Harness, Internal Mode Switch Design (10 Pin Plug)	1	00-03	94446D	35D-101C
446J	Wire Harness Extension, Internal Mode Switch Design (10 Pin Plug)	1	00-03	94446E	35D-101E
446J	Wire Harness, Internal Mode Switch Design (8 Pin Plug)	1	04-05	94446F	35D-101F
446J	Wire Harness Extension, Internal Mode Switch Design (8 Pin Plug)	1	04-05	94446G	35D-101G
446J	Wire Harness, Internal Mode Switch Design (9 Pin Plug)	1	06-08	94446H	35D-101H
446J	Wire Harness Extension, Internal Mode Switch Design (9 Pin Plug)	1	06-08	94446J	35D-101J
HARD PARTS					
Prefix Key: D = OEM, A = Aftermarket New, R = Remanufactured					
PUMPS					
500I	Pump	1	93-Up	94500A	K83990
529A	Stator Support	1	93-Up	94529A	83969
DRUMS & HUBS					
554D	Drum, Forward / Coast	1	93-Up	94554	83964
555B	Drum, 3rd Clutch	1	93-Up	94555	83999
556G	Drum, Reverse (3 Clutch) w/o Sprag	1	93-Up	94556A	83926
564D	Piston Kit, Forward Clutch	1	93-Up	94564	N/A
566G	Piston Kit, Reverse Clutch	1	93-Up	94566	N/A
575H	Hub, 3rd Clutch	1	93-Up	94575	83932
579C	Hub, Coast	1	93-Up	94579	N/A
PLANETS					
582C	Input	1	93-Up	94582	N/A
584H	Reaction	1	93-Up	94584	N/A
592C	Ring Gear, Input	1	93-Up	94592	N/A
594C	Ring Gear, Reaction	1	93-Up	94592	N/A
598E	Ring Gear, Final Drive	1	93-Up	94598	N/A
602C	Hub, Input w/ Inner Race	1	93-Up	94602	N/A
N.I.	Planet Kit, Sun Shell to Ring Gear (5 Piece)	1	93-Up	94583	K83950
SUN GEARS, SHELLS & SUPPORTS					
612H	Sun Gear, Input	1	93-Up	94612	N/A
618F	Sun Gear, Final Drive (42 T)	1	93-Up	94618	N/A
618F	Sun Gear, Final Drive (46 T)	1	93-Up	94618A	N/A
618F	Sun Gear, Final Drive (54 T)	1	93-Up	94618B	N/A
622H	Shell, Reaction	1	93-Up	94622	83978
624H	Shell, Sun Gear	1	93-Up	94624	N/A
634E	Support, Forward / Coast Drum	1	93-Up	94634	83965
SPRAGS					
652G	Sprag, Intermediate	1	93-Up	94652A	83940
654E	Sprag, Low Clutch Roller	1	93-Up	94654A	83960
658C	Sprag, Forward	1	93-Up	94658A	83945
669C	Outer Race, Forward	1	93-Up	94669	N/A
N.I.	Race Kit, Forward	1	93-Up	94663AK	N/A

ILL.	DESCRIPTION	QTY.	YEAR	PART NO.	REFERENCE NO.
SHAFTS					
671A	Shaft, Pump.....	1	93-Up	94671A	83981
673A	Shaft, Turbine.....	1	93-Up	94673A	N/A
674H	Shaft, Final Drive Sun.....	1	93-Up	94674	N/A
678B	Shaft, Oil, tput.....	1	93-Up	94678	83906
690E	Gear, Parking.....	1	93-Up	94690	N/A
CHAINS & SPROCKETS					
700A	Chain, 7/8" (Replaced by 94700B).....	1	93-94	94700A	N/A
700A	Chain, 1" (Replaces 94700A).....	1	93-Up	94700B	83973A
N.I.	Sprocket Kit (Drive & Driven Sprockets).....	1	93-Up	94705BK	K83973A
705A	Sprocket, Drive (.780", 39 T).....	1	93-Up	94705A	N/A
705A	Sprocket, Drive (.900", 39 T).....	1	93-Up	94705	N/A
706A	Sprocket, Driven (.780", 39 T).....	1	93-Up	94706A	N/A
706A	Sprocket, Driven (.900", 39 T).....	1	93-Up	94706	N/A
713A	Driven Sprocket Support (Cast # 8683160).....	1	93-94	94713	83949
713A	Driven Sprocket Support (Cast # 24206735).....	1	95-Up	94713A	83949A
DIFFERENTIALS					
715F	Differential Assembly (42 T Sun Gear, 36 T Pinion).....	1	93-Up	94715K	K83972
715F	Differential Assembly (54 T Sun Gear, 30 T Pinion).....	1	93-Up	94715AK	K83972A
VALVE BODIES					
740K	Valve Body - Lower (Premium) (Exc 1193 Stamp).....	1	93-99	94740-3L	P83991
740K	Valve Body - Lower (Premium) (1193 Stamp).....	1	1994	94740-4L	P83991A
740K	Valve Body - Lower (Premium) (5347 Stamp).....	1	00-03	94740-5L	P83991B
740K	Valve Body - Lower (Premium) (5286 Stamp).....	1	03-Up	94740-6L	P83991C
740K	Valve Body - Upper (Premium).....	1	93-03	94740-1U	P83991J
740K	Valve Body - Upper (Premium).....	1	04-Up	94740-2U	P83991K
744K	Accumulator Body (Cast 8685668).....	1	93-Up	94744	N/A
VALVE BODY COMPONENTS					
741E	Solenoid Clip, Variable Force Motor.....	1	93-Up	34843E	34152A
741E	Valve Assembly, Pressure Regulator Boost.....	1	93-Up	94741F	K83971
741EE	Valve w/ Sleeve, AFL (Requires T-72854-TL Reamer).....	1	93-Up	94741LK	K83882
741	Valve w/ Sleeve, TCC (Requires T-72854-TL2 Reamer).....	1	93-Up	94741QK	K83884
CASES & HOUSINGS					
755I	Case Cover (Uses One 2-3 Accum Spring).....	1	93-Up	94755	N/A
755I	Case Cover (Uses Two 2-3 Accum Spring) (Cast # 24200293).....	1	93-Up	94755A	83995
760J	Case (Cast # 8683748).....	1	93-96	94760	N/A
760J	Case (Cast # 8685109).....	1	93-96	94760A	N/A
760J	Case (Cast # 8685564).....	1	96-Up	94760B	N/A
765K	Pan, Bottom.....	1	93-Up	94765	N/A
766I	Pan, Side.....	1	93-Up	94766	N/A
770J	Extension Housing, 7 1/4" Long (Cast # 8683545).....	1	93-Up	94770A	83998
MISCELLANEOUS COMPONENTS					
852	Cushion, 2nd Clutch.....	1	93-Up	94852	N/A
854	Cushion, Reverse Clutch (.030").....	1	93-Up	94854	N/A
854	Cushion, Reverse Clutch (.070").....	1	93-Up	94854A	N/A
900K	Servo Assembly, 4th.....	1	93-Up	94900	N/A
906	Spring, 2-1 Servo Return.....	1	93-Up	94906	N/A
927	Piston, Forward Accumulator.....	1	93-Up	94927	83993
927	Piston, 1-2 Accumulator.....	1	93-Up	94927B	83993B
931	Spring, 2-3 Accumulator (White).....	1	93-Up	94931	N/A

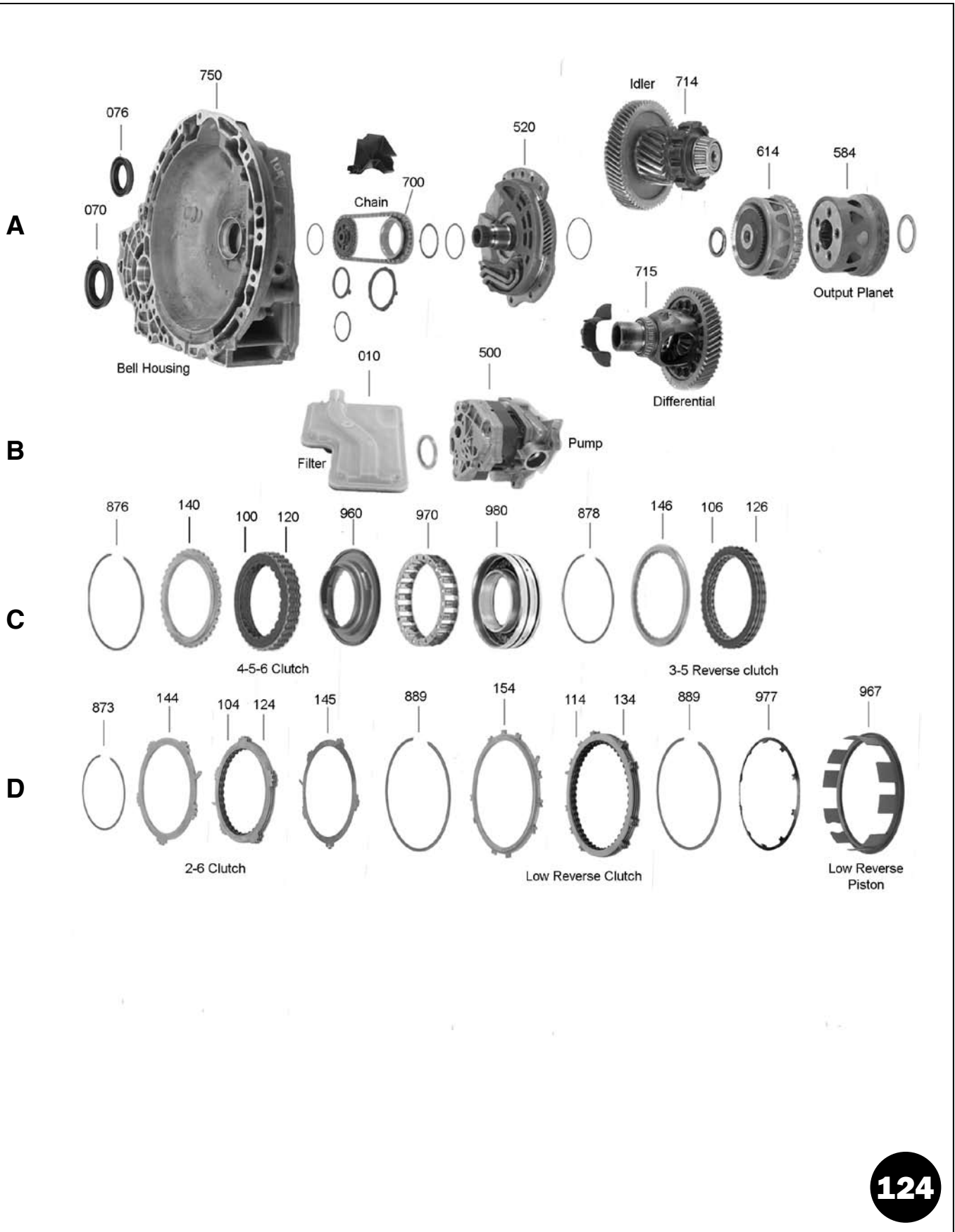

6 SPEED

GM 6T70, 6T75 Ford 6F50, 6F55

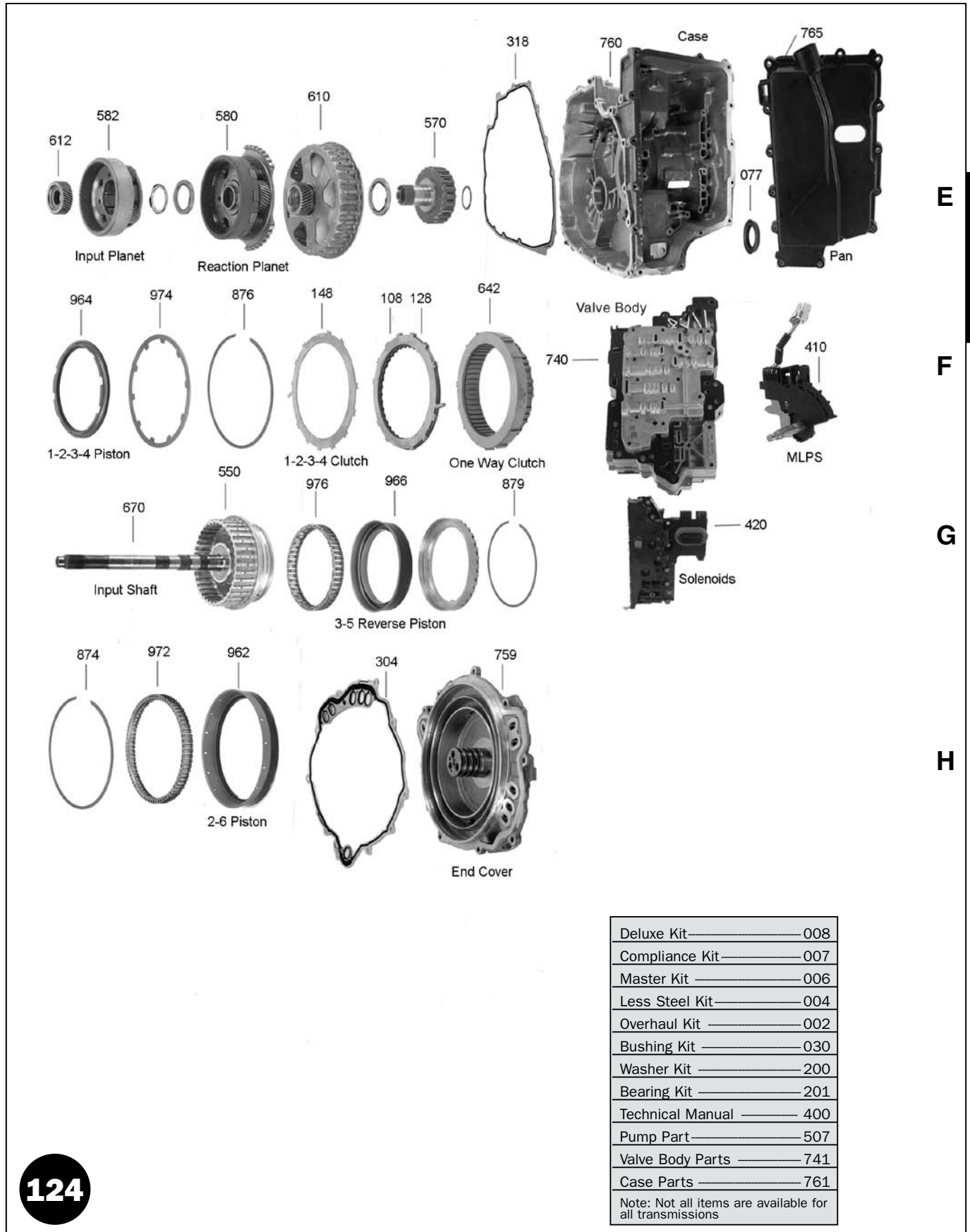

6T70, 6F50

E

F

G

H

Deluxe Kit	008
Compliance Kit	007
Master Kit	006
Less Steel Kit	004
Overhaul Kit	002
Bushing Kit	030
Washer Kit	200
Bearing Kit	201
Technical Manual	400
Pump Part	507
Valve Body Parts	741
Case Parts	761
Note: Not all items are available for all transmissions	

ILL.	DESCRIPTION	QTY.	YEAR	PART NO.	REFERENCE NO.
MASTER OVERHAUL KITS (WITH STEELS)					
006H	6T70, 6T75 (GM).....	1	07-Up	124006	N/A
006H	6F50, 6F55 (Ford).....	1	07-Up	124006A	N/A
LESS STEEL KITS					
004H	6T70, 6T75 (GM).....	1	07-Up	124004	N/A
004H	6F50, 6F55 (Ford).....	1	07-Up	124004A	N/A
OVERHAUL KITS (W/ RINGS & SEALS)					
002H	6T70, 6T75 (GM).....	1	07-Up	124002	N/A
002H	6F50, 6F55 (Ford).....	1	07-Up	124002A	N/A
FILTERS					
010B	6T70, 6T75 (GM).....	1	07-Up	124010	N/A
010B	6F50, 6F55 (Ford).....	1	07-Up	124010A	N/A
BUSHINGS					
030H	Bushing Kit, 6T70, 6T75 (GM).....	1	07-Up	124030	N/A
030H	Bushing Kit, 6F50, 6F55 (Ford).....	1	07-Up	124030A	N/A
METAL CLAD SEALS					
070A	Converter.....	1	07-Up	124070	N/A
076A	Axle, Bell Housing.....	1	07-Up	124076	N/A
077E	Axle Case.....	1	07-Up	124076	N/A
FRICTION PLATES					
100C	Overdrive (4-5-6).....	5-6	07-Up	124100	N/A
104D	Intermediate (2-6).....	4-5	07-Up	124104	N/A
106C	Direct (3-5/Reverse).....	3-4	07-Up	124106	N/A
108F	Forward (1-2-3-4).....	4-5	07-Up	124108	N/A
114D	Low/ Reverse.....	4-5	07-Up	124114	N/A
STEEL PLATES					
120C	Overdrive (4-5-6).....	5-6	07-Up	124120	N/A
121C	Overdrive (4-5-6) Waved.....	1	07-Up	124121	N/A
124D	Intermediate (2-6).....	4-7	07-Up	124124	N/A
125D	Intermediate (2-6) Waved.....	1	07-Up	124125	N/A
126C	Direct (3-5/Reverse).....	3-4	07-Up	124126	N/A
127C	Direct (3-5/Reverse) Waved.....	1	07-Up	124127	N/A
128F	Forward (1-2-3-4).....	4-5	07-Up	124128	N/A
129F	Forward (1-2-3-4) Waved.....	1	07-Up	124129	N/A
134D	Low/ Reverse.....	4-5	07-Up	124134	N/A
135D	Low/ Reverse Waved.....	1	07-Up	124135	N/A
PRESSURE PLATES					
Prefix Key: D = OEM, A = Aftermarket New, R = Remanufactured					
140C	Overdrive (4-5-6).....	1	07-Up	124140	N/A
144D	Intermediate (2-6).....	1	07-Up	124144	N/A
146C	Direct (3-5/Reverse).....	1	07-Up	124146	N/A
148F	Forward (1-2-3-4).....	1	07-Up	124148	N/A
154D	Low/ Reverse (Apply Plate) (.160") (GM).....	1	07-Up	124154	N/A
154D	Low/ Reverse (Apply Plate) (.115") (Ford).....	1	07-Up	124154A	N/A
155D	Low/ Reverse (Backing Plate) (.151") (GM).....	1	07-Up	124155	N/A
155D	Low/ Reverse (Backing Plate) (.191") (Ford).....	1	07-Up	124155A	N/A
SEALING RING KITS					
175H	All.....	1	07-Up	124175	N/A

6 SPEED

GM 6T70, 6T75 Ford 6F50, 6F55

ILL.	DESCRIPTION	QTY.	YEAR	PART NO.	REFERENCE NO.
THRUST WASHER KITS					
200H	All.....	1	07-Up	124200	N/A
BEARING KITS					
201H	All.....	1	07-Up	124201	N/A
GASKETS & O-RINGS					
300E	Gasket, Pan (All)	1	07-Up	124300	N/A
304	Gasket, End Cover (All)	1	07-Up	124304	N/A
318	Gasket, Bell Housing (GM Only).....	1	07-Up	124318	N/A
TECHNICAL MANUALS					
400H	GM	1	07-Up	124400	N/A
400H	Ford.....	1	07-Up	124400A	N/A
HARD PARTS					
Prefix Key: D = OEM, A = Aftermarket New, R = Remanufactured					
PUMPS					
750A	Pump Body (Bell Housing)	1	07-Up	124750	N/A
520A	Stator.....	1	07-Up	124520	N/A
532	Rotor (21.95mm).....	1	07-Up	124532	N/A
533	Vanes (21.95mm).....	7	07-Up	124533	N/A
534	Slide	1	07-Up	124534	N/A
538	Ring.....	2	07-Up	124538	N/A
DRUMS & CLUTCH HUBS					
550G	Overdrive w/ Shaft (4-5-6)	1	07-Up	124550	N/A
PLANETS					
580E	Reaction	1	07-Up	124580	N/A
582E	Input.....	1	07-Up	124582	N/A
584A	Output.....	1	07-Up	124584	N/A
SPRAGS					
642F	Sprag Assembly, Low	1	07-Up	124642	N/A
VALVE BODIES					
740F	Valve Body.....	1	07-Up	124740	N/A
MISCELLANEOUS COMPONENTS					
700A	Chain w/ Sprockets (Pump Drive).....	1	07-Up	124700K	N/A
962H	Bonded Piston, 2-6	1	07-Up	124962	N/A
964F	Bonded Piston, 1-2, 3-4.....	1	07-Up	124964	N/A
966G	Bonded Piston, 3-5/ Reverse	1	07-Up	124966	N/A
967D	Bonded Piston, Low/ Reverse.....	1	07-Up	124967	N/A
980C	Bonded Retainer, 4-5-6	1	07-Up	124980	N/A

6T70, 6F50

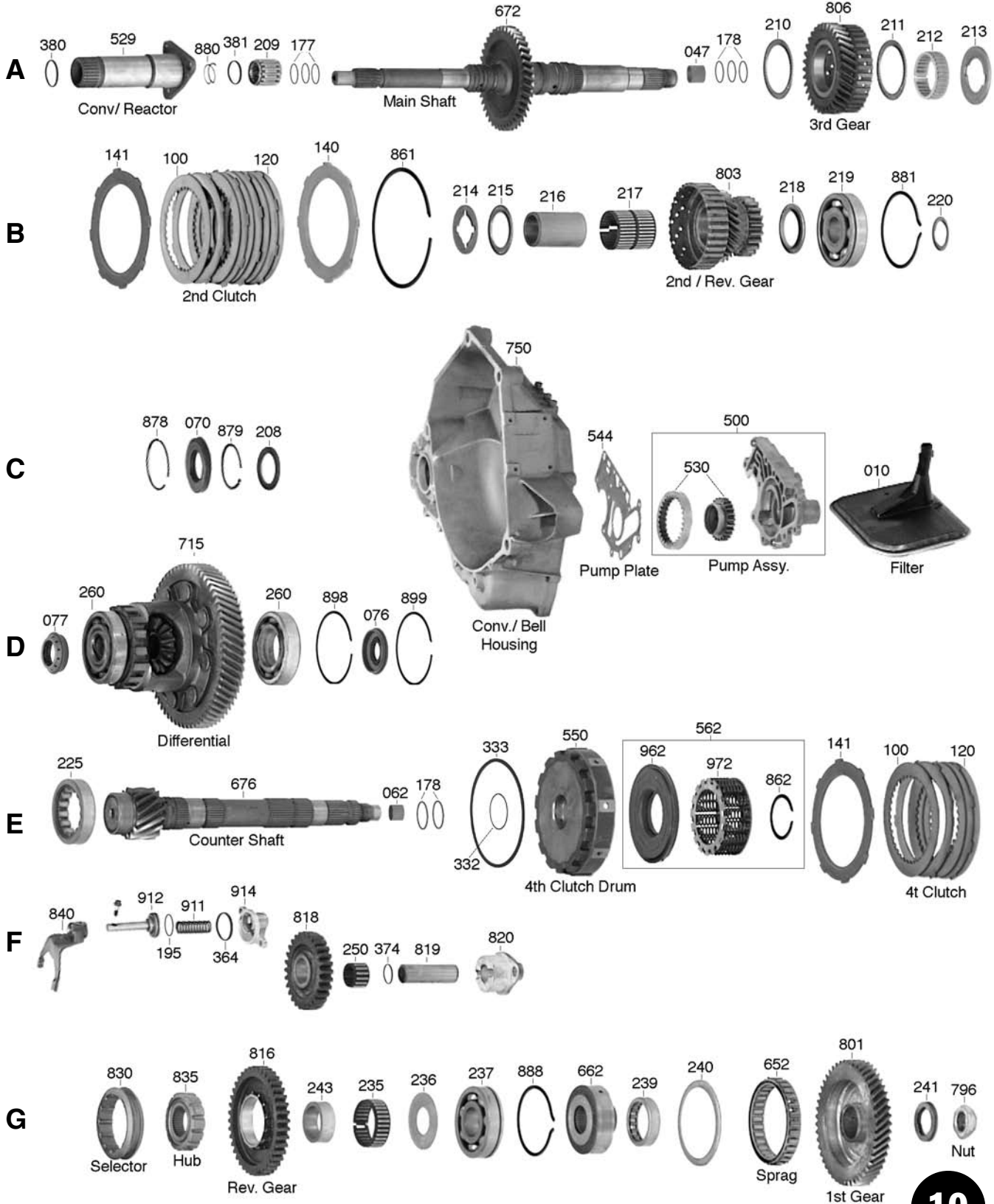

FWD - 4 SPEED TRANSAXLE TAAT

GM SATURN

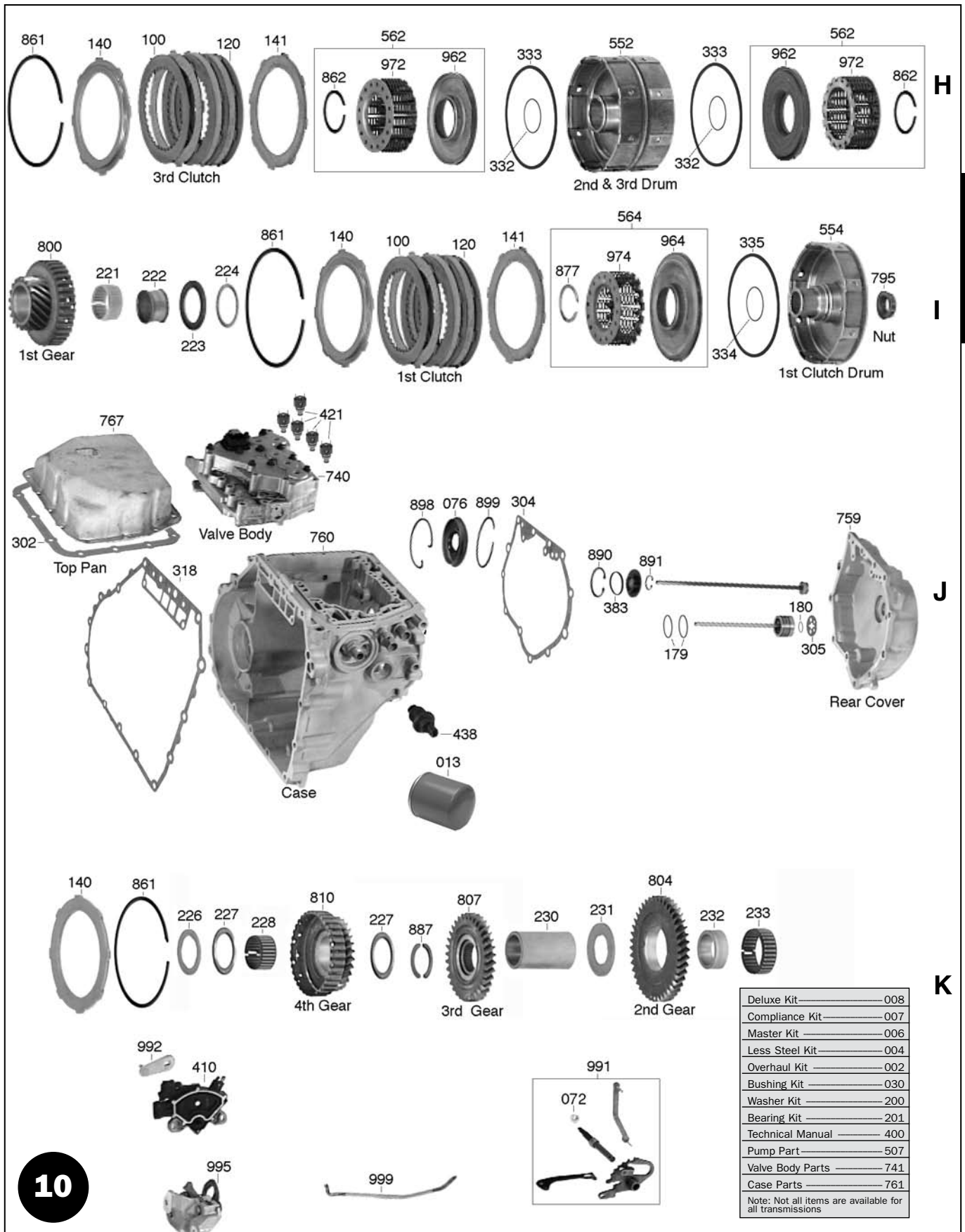

SATURN TAAT

H

I

J

K

10

Deluxe Kit	008
Compliance Kit	007
Master Kit	006
Less Steel Kit	004
Overhaul Kit	002
Bushing Kit	030
Washer Kit	200
Bearing Kit	201
Technical Manual	400
Pump Part	507
Valve Body Parts	741
Case Parts	761

Note: Not all items are available for all transmissions



10010A



10013A

Various Models Including SL, SL1, SL2, SC
MP6 - w/Converter; MP7 - w/Electric Converter

Saturn LS 00-Up Use 4T40E/4T45E

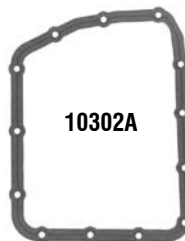

10302A

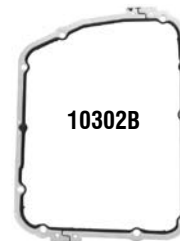

10302B

ILL.	DESCRIPTION	QTY.	YEAR	PART NO.	REFERENCE NO.
DELUXE KITS (SUPER KITS) (1)					
008	Saturn Taat (w/ Bonded Pistons)	1	91-02	10008APF	K8100-R
MASTER OVERHAUL KITS (WITH STEELS) (1)					
006	Saturn Taat (w/ Bonded Pistons)	1	91-02	10006APF	K8100
OVERHAUL KITS (W/ RINGS & SEALS) (1)					
002	Saturn Taat (w/ Bonded Pistons)	1	91-02	10002APF	K81900
002	Saturn Taat (w/o Bonded Pistons)	1	91-02	10002AF	N/A
<i>(1) - Does not incl 97-02 #10302B Molded Top Cover Gasket</i>					
FILTERS					
010C	Sump (Internal).....	1	91-02	10010A	81800
013J	Spin-On (External).....	1	91-02	10013A	81801
015	Screen, Large Thimble Flushing.....	1	91-02	10015	81711A
017	Screen, Small Thimble Solenoid (w/ Brass Rim)	1	91-02	10017	81711
METAL CLAD SEALS					
070C	Front.....	1	91-02	10070A	81201
074	Rear Cover to Pinion Shaft Pilot (Black Plastic).....	1	91-02	10074A	81204
076J	Right Axle (Bell Housing Side)	1	91-02	10076B	81202
077D	Left Axle (Case Side).....	1	91-02	10077B	81203
FRICITION PLATES					
100B	All (1 Sided, 36 Internal T).....	15	91-02	10100A	81103
120B	All (1 Sided, 8 External T).....	11	91-02	10120A	81100
141B	Apply Plate, Bottom Plates of All Drums (1 Sided Friction, External T)	4	91-02	10141A	81714
VALVE BODY RECALIBRATION KITS					
165	Sure Cure Kit (requires T-95200-TL) (Sonnax)	1	91-02	S10174	81S01
GASKETS & O-RINGS					
302J	Gasket, Top Pan (Fiber w/ Silicone Bead).....	1	91-96	10302A	13912
302J	Gasket, Top Pan (Metal & Bonded Rubber) (not included in kits)	1	97-02	10302B	13912R
304J	Gasket, Rear/ Side Cover.....	1	91-02	10304A	13913
318J	Gasket, Case to Converter Housing	1	91-02	10318A	13914
381A	O-Ring, Converter Reactor Shaft to Bell Housing	1	91-02	10381A	N/A
381A	O-Ring, Converter Hub to Reactor Shaft	1	91-02	10381AA	N/A
TECHNICAL MANUALS					
400	Tech Manual	1	91-02	10400A	81Y01
ELECTRICAL COMPONENTS					
410K	MLPS (w/ Grooves)	1	95-02	10410A	15A-196
410K	MLPS (w/ Flats)	1	95-02	10410B	15A-196B
414	Switch, Solenoid Connector Plate	1	91-02	10414	15A-195

FWD - 4 SPEED TRANSAXLE TAAT

GM SATURN

ILL.	DESCRIPTION	QTY.	YEAR	PART NO.	REFERENCE NO.
ELECTRICAL COMPONENTS (Cont.)					
421J	Solenoid, Black or Blue Top (5 Per Unit).....	5	91-92	10421A	5A-195
421J	Solenoid, White Top (5 Per Unit).....	5	93-02	10421AC	5A-195B
438J	Sensor, Input & Output (TSS / VSS).....	2	91-02	10436	20A-195
446	Wiring Harness, External Repair Solenoid	1	91-02	10446K	35A-195
HARD PARTS					
Prefix Key: D = OEM, A = Aftermarket New, R = Remanufactured					
SPRAGS					
652G	Input Sprag	1	91-02	10652A	81940
662G	Inner Race	1	91-02	10662A	N/A
SHAFTS					
672A	Mainshaft, 40 T 4th Gear.....	1	91-02	10672A	N/A
672A	Mainshaft, 42 T 4th Gear.....	1	91-02	10672B	N/A
676E	Countershaft, Output Shaft 15 Teeth	1	91-02	10676A	N/A
676E	Countershaft, Output Shaft 16 Teeth	1	91-02	10676B	N/A
676E	Countershaft, Output Shaft 17 Teeth	1	91-02	10676C	N/A
DIFFERENTIALS					
715D	Differential Assembly w/ 62 T Ring Gear.....	1	91-94	10715A	81993
715D	Differential Assembly w/ 65 T Ring Gear.....	1	95-02	10715B	81993B
VALVE BODIES					
740J	Valve Body, 1st Design (Premium) (Large Valve in Bottom).....	1	91-92	10740-2	P81990
740J	Valve Body, 2nd Design (Premium) (4 Holes in Bottom).....	1	93-02	10740-1	P81990B
741	Pressure Regulator Valve.....	1	91-02	10741P-1	81966V
741	Pressure Regulator Spring.....	1	91-02	10741P-3	81965S
741	Boost Valve, Pressure Regulator.....	1	91-02	10741F	K81967
741	Sleeve, Pressure Regulator Valve (Req T-95200-TL).....	1	91-02	10741P-2	81966S
MISCELLANEOUS COMPONENTS					
507	Valve Retainer, Lube Relief (Inc. Clip & Plug 3 Pack)	1	91-02	10507K	K81969
912F	Piston, Servo (1st Design) Up to VIN# NZ205624.....	1	91-92	10912A	N/A
912F	Piston, Servo (2nd Design) w/ VIN# NZ205625 & Up.....	1	92-96	10912AA	N/A
962E	Piston, For 2nd, 3rd & 4th Clutch Drums (Bonded)	3	91-02	10962A	81528A
964I	Piston, 1st Clutch Drum (Bonded)	1	91-02	10964A	81528
972E	Retainer w/ Spring, 2nd/3rd & 4th Clutch Drums	3	91-02	10972A	N/A
974I	Retainer w/ Spring, 1st Clutch Drum.....	1	91-02	10974A	N/A
991K	Linkage Assembly, Internal.....	1	91-02	10991A	N/A
Tool	Piston Installation Kit.....	1	91-02	T-3530	T-3530
Tool	Servo Ring Installer.....	1	91-02	T-3531	T-3531

SATURN TAAT

A

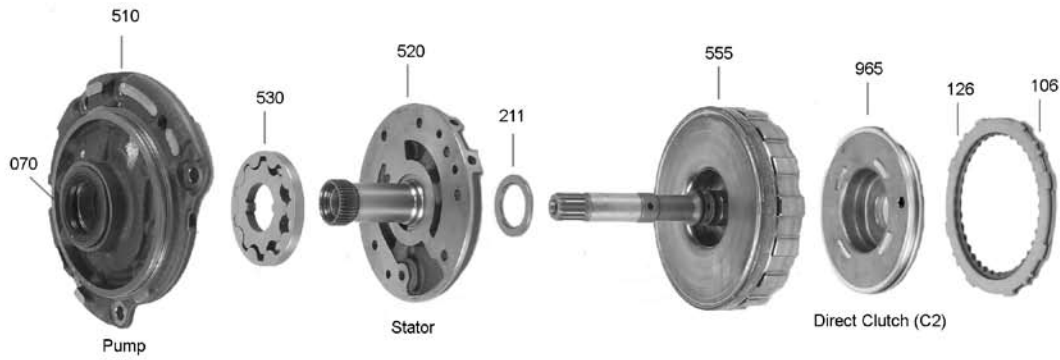

B

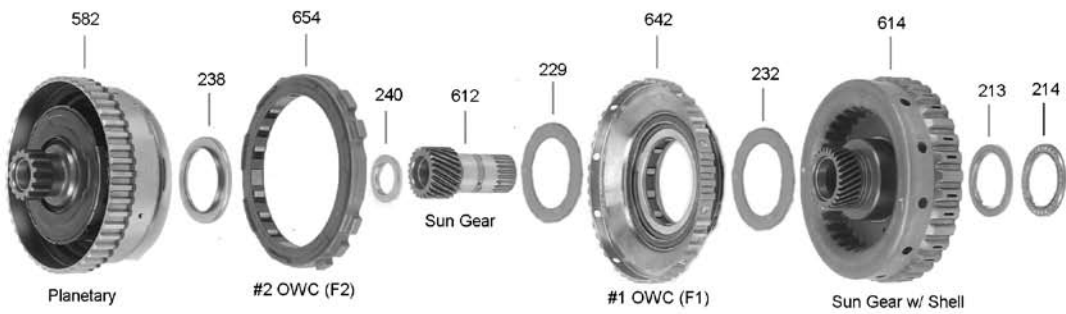

C

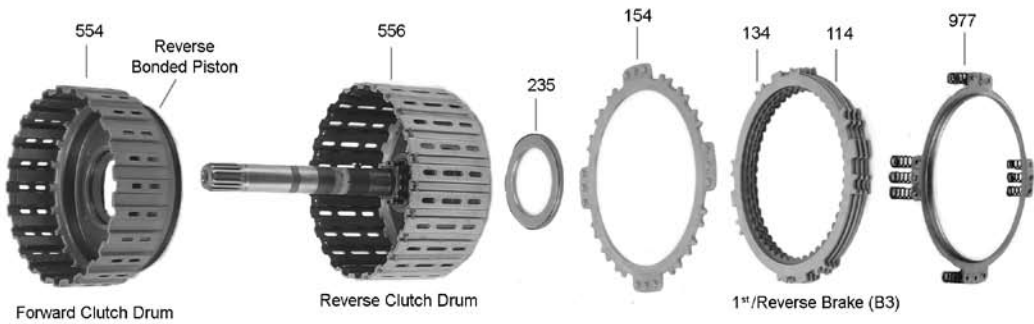

D

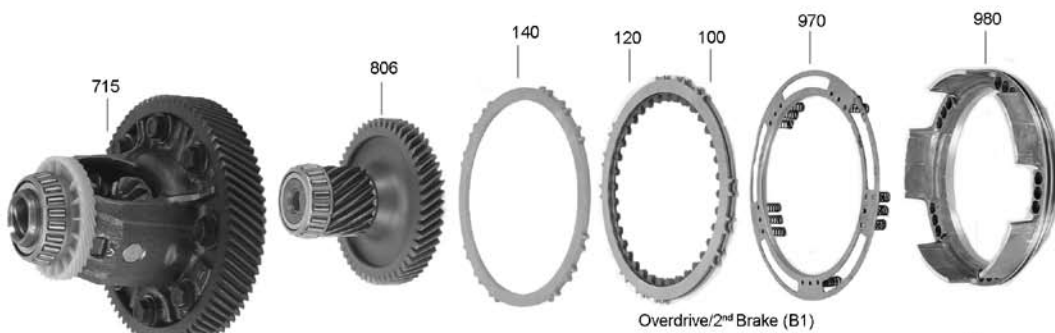

E

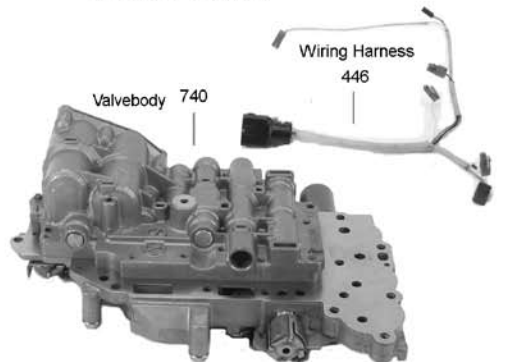

4 SPEED

AW80/81-40LE

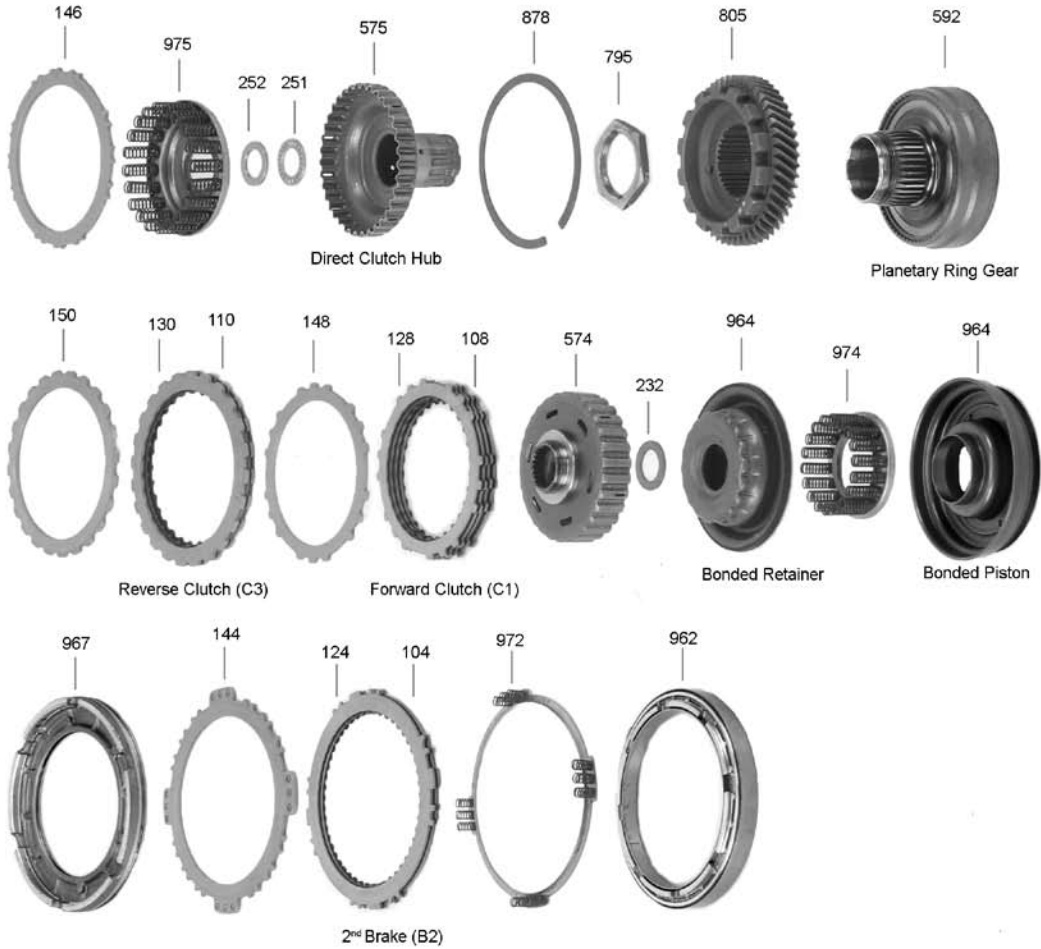

F

G

H

Deluxe Kit	008
Compliance Kit	007
Master Kit	006
Less Steel Kit	004
Overhaul Kit	002
Bushing Kit	030
Washer Kit	200
Bearing Kit	201
Technical Manual	400
Pump Part	507
Valve Body Parts	741
Case Parts	761

Note: Not all items are available for all transmissions

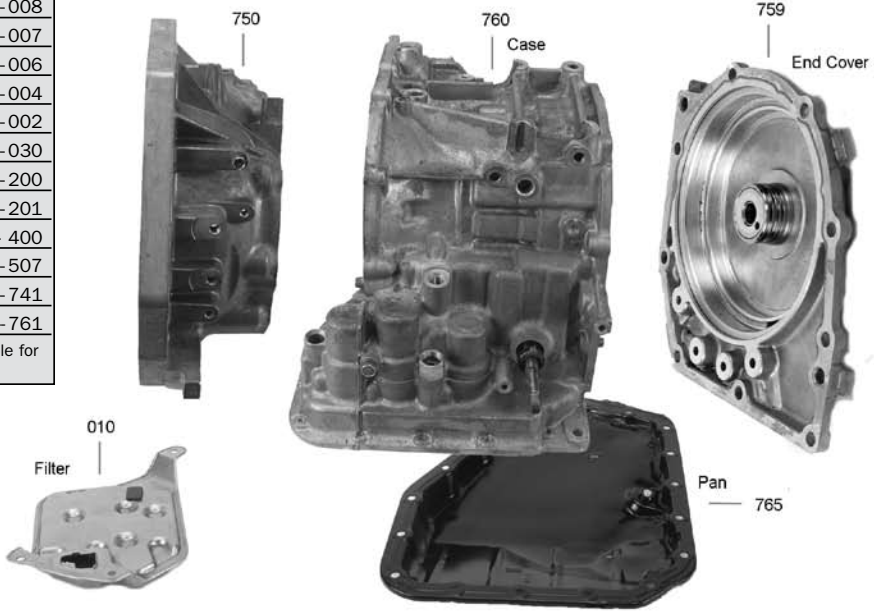

I

ILL.	DESCRIPTION	QTY.	YEAR	PART NO.	REFERENCE NO.
MASTER OVERHAUL KITS (WITH STEELS)					
006I	AW80/81-40LE, U440E.....	1	04-Up	199006	N/A
LESS STEEL KITS					
004I	AW80/81-40LE, U440E.....	1	04-Up	199004	N/A
OVERHAUL KITS (W/ RINGS & SEALS)					
002I	AW80/81-40LE, U440E.....	1	04-Up	199002	N/A
FILTERS					
010I	AW80/81-40LE, U440E.....	1	04-Up	199010	N/A
BUSHINGS					
030I	Bushing Kit	1	04-Up	199030	N/A
METAL CLAD SEALS					
070	Front Pump	1	04-Up	57070A	N/A
076	Axle, Bell Housing	1	04-Up	199076	N/A
077	Axle, Case.....	1	04-Up	199074	N/A
FRICITION PLATES					
100D	Overdrive (B1).....	5-6	04-Up	199100	N/A
104H	Intermediate (B2)	4-5	04-Up	199104	N/A
106A	Direct (C2)	3-4	04-Up	199106	N/A
108G	Forward (C1)	4-5	04-Up	199108	N/A
110G	Reverse (C3).....	4-5	04-Up	199110	N/A
114C	Low/ Reverse (B3)	4-5	04-Up	199114	N/A
STEEL PLATES					
120D	Overdrive (B1).....	5-6	04-Up	199120	N/A
124H	Intermediate (B2)	4-7	04-Up	199124	N/A
126A	Direct (C2)	3-4	04-Up	199126	N/A
128G	Forward (C1)	4-5	04-Up	199128	N/A
130G	Reverse (C3).....	4-5	04-Up	199130	N/A
134C	Low/ Reverse (B3)	4-5	04-Up	199134	N/A
PRESSURE PLATES					
Prefix Key: D = OEM, A = Aftermarket New, R = Remanufactured					
140D	Overdrive (B1).....	1	04-Up	199140	N/A
144H	Intermediate (B2)	1	04-Up	199144	N/A
146F	Direct (C2)	1	04-Up	199146	N/A
148G	Forward (C1)	1	04-Up	199148	N/A
150G	Reverse (C3).....	1	04-Up	199150	N/A
154C	Low/ Reverse (B3)	1	04-Up	199154	N/A
SEALING RING KITS					
175I	Sealing Ring Kit.....	1	04-Up	199175	N/A
THRUST WASHER KITS					
200I	Thrust Washer Kit	1	04-Up	199200	N/A
BEARING KITS					
201I	Bearing Kit	1	04-Up	199201	N/A
GASKETS & O-RINGS					
300I	Pan Gasket.....	1	04-Up	199300	N/A

4 SPEED

AW80/81-40LE

ILL.	DESCRIPTION	QTY.	YEAR	PART NO.	REFERENCE NO.
TECHNICAL MANUALS					
400I	AW80/81-40LE (Aveo).....	1	04-Up	199400	N/A
400I	U440E, U441E (Yaris, Echo) (OE Manual).....	1	04-Up	199400A	N/A
ELECTRICAL COMPONENTS					
421	Shift # 1 & Shift # 2.....	2	04-Up	199421	N/A
425	Lock-up (TCC).....	1	04-Up	199425	N/A
425	Lock-up Control.....	1	04-Up	199425A	N/A
431	EPC.....	1	04-Up	199431	N/A
HARD PARTS					
Prefix Key: D = OEM, A = Aftermarket New, R = Remanufactured					
PUMPS					
510A	Pump Body.....	1	04-Up	199510	N/A
520A	Pump Cover (Stator).....	1	04-Up	199520	N/A
530A	Pump Gears.....	1	06-Up	199530	N/A
DRUMS & CLUTCH HUBS					
554A	Forward (C1).....	1	04-Up	199554	N/A
555A	Direct (C2).....	1	04-Up	199555	N/A
556C	Reverse (C3).....	1	04-Up	199556	N/A
574G	Hub, Forward.....	1	04-Up	199574	N/A
575F	Hub, Direct.....	1	04-Up	199575	N/A
578B	Hub, Reverse.....	1	04-Up	199578	N/A
PLANETS					
582B	Planet.....	1	04-Up	199582	N/A
592F	Ring Gear.....	1	04-Up	199592	N/A
SUN GEARS					
612B	Sun Gear, Forward.....	1	04-Up	199612	N/A
612B	Sun Gear, Reaction w/ Shell.....	1	04-Up	199614	N/A
SPRAGS					
642B	One Way Clutch Hub & Sprag (F1).....	1	04-Up	199642	N/A
654B	One Way Clutch, Low (F2).....	1	04-Up	199654	N/A
DIFFERENTIALS					
715D	Assembly (75 T Ring, 20 T Small Idler, 45 T Large Idler) (Aveo).....	1	04-Up	199715K	N/A
715D	Assembly (77 T Ring, 19 T Small Idler, 52 T Large Idler) (Daewoo).....	1	04-Up	199715AK	N/A
VALVE BODIES					
740E	Valve Body.....	1	04-Up	199740	N/A
CASES & HOUSINGS					
760I	Case.....	1	04-Up	199760	N/A
759I	End Cover.....	1	04-Up	199759	N/A
765I	Pan.....	1	04-Up	199765	N/A
MISCELLANEOUS COMPONENTS					
962H	Piston, Intermediate.....	1	04-Up	199962	N/A
964G	Piston, Forward.....	1	04-Up	199964	N/A
964G	Piston Retainer, Forward.....	1	04-Up	199964A	N/A
967H	Piston, Low/ Reverse.....	1	04-Up	199967	N/A

POWERGLIDE ALUMINUM CASE



Chevrolet 62-73
Pontiac 70-73
Tempest T6 64

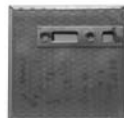

ILL.	DESCRIPTION	QTY.	YEAR	PART NO.	REFERENCE NO.
DELUXE KITS (SUPER KITS) (1)					
008	Aluminum Powerglide	1	62-73	114008	K2800B-R
COMPLIANCE KITS (CALIFORNIA KITS) (1)					
007	Aluminum Powerglide	1	62-73	114007	CK2800B-R
MASTER OVERHAUL KITS (WITH STEELS) (1)					
006	Aluminum Powerglide	1	62-73	114006	K2800B
LESS STEEL KITS (1)					
004	Aluminum Powerglide	1	62-73	114004	K2800B-LS
OVERHAUL KITS (W/ RINGS & SEALS) (1)					
002	Aluminum Powerglide	1	62-73	114002	K28900
GASKET & SEAL KITS (W/O RINGS & SEALS) (1)					
000	Aluminum Powerglide	1	62-73	114000	K28900-1
FILTER KITS (1)					
011	Aluminum Powerglide	1	62-73	114011	FK28739A
FILTERS					
010	Aluminum Powerglide	1	62-73	114010	28739A
BANDS					
Prefix Key: B = Borg Warner, A = OEM (Exc BW), N = All Other New, R = Relined					
022	Low	1	62-73	114022	8314A
022	Low (High Performance)	1	62-73	114022HP	8314HR
BUSHINGS					
030	Bushing Kit	1	62-73	114030	K28901
034	Pump Body	1	62-73	44034	8005
034	Clutch Drum	1	62-73	54034A	32005
046	Rear Pump Body & Governor	2	62-73	114034B	28001
052	Sun Gear	1	62-73	114052	N/A
062	Output Shaft Pilot	1	62-73	44062	8004
064	Case	1	62-73	114064	28002
066	Extension Housing	1	62-73	44066	8008A
METAL CLAD SEALS					
070	Front	1	62-73	44070	38151V
072	Linkage	1	62-73	114072	3768L
074	Rear	1	62-73	44074	8850B
FRICTION PLATES					
106	High (.098")	4	62-73	114106	18305B
106	High (.098") (Hi-Performance) (Blue)	4	62-73	R114106HP	N/A
106	High (.098") (Hi-Performance) (Red)	4	62-73	A114106HP	18305BR
106	High (.062") (Hi-Performance) (Blue)	4	62-73	R114106AHP	18305X
106	High (.062") (Hi-Performance) (Red)	4	62-73	A114106AHP	18305BRX
114	Reverse	5	62-73	44114	18506
114	Reverse (Hi-Performance) (Red)	5	62-73	A44114HP	18506R

POWERGLIDE ALUMINUM CASE

ILL.	DESCRIPTION	QTY.	YEAR	PART NO.	REFERENCE NO.
STEEL PLATES					
126	High (.070")	3-5	62-73	114126	18306B
126	High (.070") (Kolene)	3-5	62-73	114126C	18306BK
126	High (.060") (Kolene)	3-5	62-73	114126A	18306BXX
126	High w/ Holes (Kolene).....	3-5	62-73	114126D	18306HK
130	Reverse (.070").....	4-6	62-73	114130	18507A
FRICTION & STEEL KITS					
106	Friction Kit, High (.060") (Hi-Perf "Red Eagle") (8 Per Kit).....	1	62-73	A114106AHPK	N/A
106	Friction & Steel Kit, High "Power Pack" (.060" Hi-Perf "Red Eagle" & Kolene).....	1	62-73	A114106APPK	N/A
114	Friction & Steel Kit, Reverse, Anti Drag "Power Pack"	1	62-73	A114114PPK	N/A
N.I.	Steel Module	1	62-73	114139	N/A
MODULATORS					
160	Adjustable.....	1	62-73	114160	28738X
VALVE BODY RECALIBRATION KITS					
165	Reprogramming Kit™ , Automatic or Stick; Full Race/Street 1963-73 (Transgo®)	1	62-73	T114171	PG-2S
SEALING RINGS					
175	Ring Kit.....	1	62-73	114175	K28902
177	Input Shaft	2	62-73	114177	5301A
179	High Clutch Drum & Governor	4	62-73	114179	8200
195	Low Servo	1	62-73	114195	18608B
THRUST WASHERS					
322	Washer, Direct Drum .078".....	1	62-73	114229B	N/A
247	Washer, Rear Sun Gear.....	1	62-73	114247	N/A
GASKETS & O-RINGS					
300	Gasket, Bottom Pan (Cork).....	1	62-73	114300	3758LX
300	Gasket, Bottom Pan (Fiber).....	1	62-73	114300F	3758F
306	Gasket, Governor Cover (w/o Rear Pump)	1	62-73	114306	N/A
307	Gasket, Low Servo Cover	1	62-73	114307	3763L
310	Gasket, Front Pump	1	62-73	114310	3762L
311	O-Ring, Front Pump	1	62-73	114311	3808L
320	Gasket, Throttle Valve Cover	1	62-73	114320	N/A
320	Gasket, Upper Valve Body (w/ Rear Pump)	1	62-66	114320A	N/A
320	Gasket, Upper Valve Body (No Rear Pump).....	1	67-73	114320B	13252
321	Gasket, Lower Valve Body (w/ Rear Pump).....	1	62-66	114321B	N/A
321	Gasket, Lower Valve Body (No Rear Pump)	1	67-73	114320B	13252
326	Gasket, Filter	1	62-73	114326	3759L
327	Gasket, Modulator	1	62-73	114327	3543
348	Lathe Cut Seal, Extension Housing to Case	1	62-73	114348	3760L
359	O-Ring, Low Servo.....	1	62-73	114359	3764L
HARD PARTS					
Prefix Key: D = OEM, A = Aftermarket New, R = Remanufactured					
500	Pump.....	1	62-73	114500	28200-R-SW
529	Shaft, Stator Support (Stator Tube).....	1	62-73	114529	N/A
530	Pump Gears	1	62-73	114530	K28201
575	Clutch Hub, Direct.....	1	62-73	114575	N/A

ALUM P-GLIDE

ALLISON (M74) LCT 1000/2000/2400

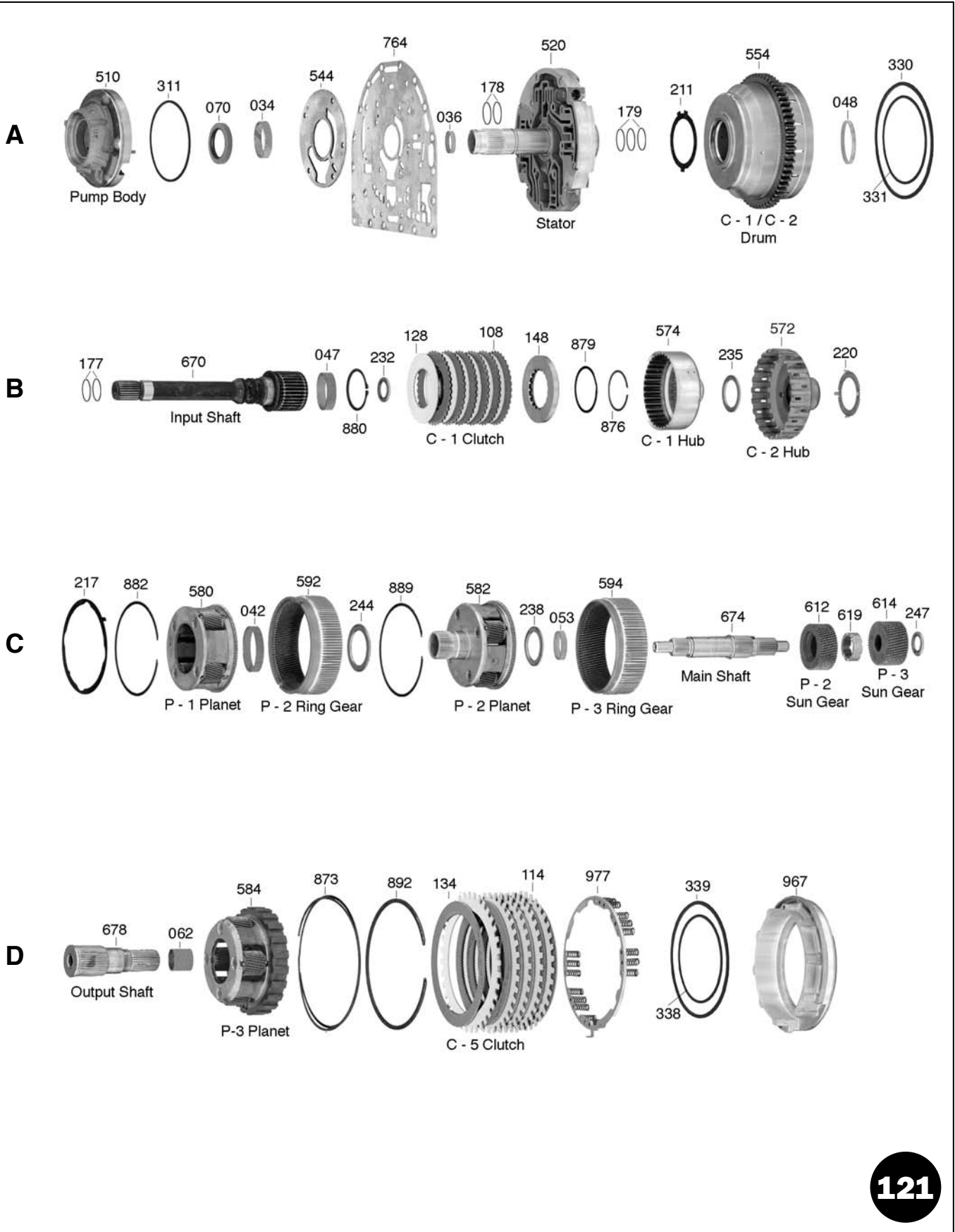

ALLISON (M74) LCT 1000/2000/2400

LCT 1000



E



F

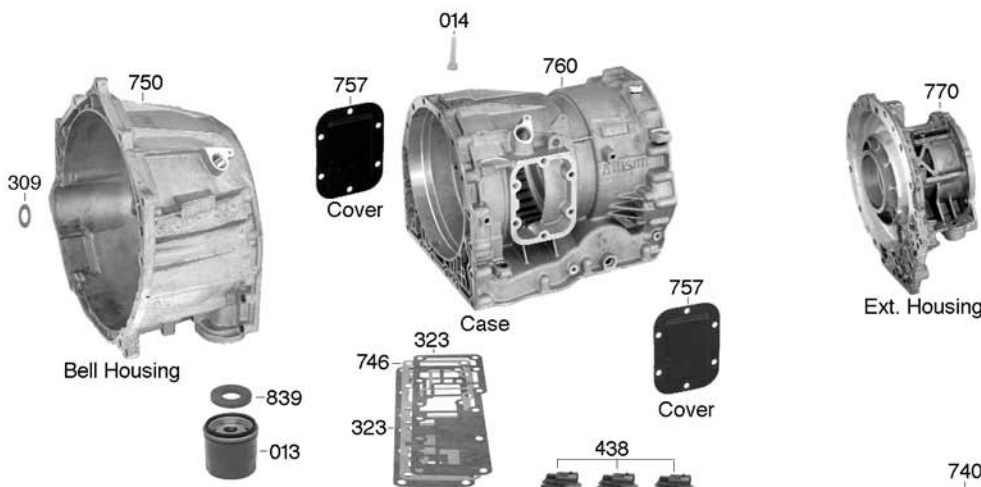

G

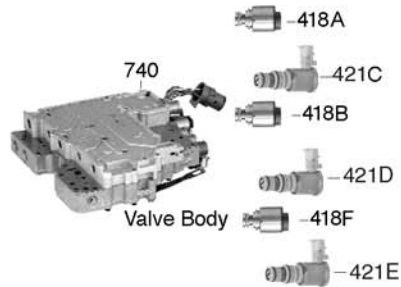

H



I

Deluxe Kit	008
Compliance Kit	007
Master Kit	006
Less Steel Kit	004
Overhaul Kit	002
Bushing Kit	030
Washer Kit	200
Bearing Kit	201
Technical Manual	400
Pump Part	507
Valve Body Parts	741
Case Parts	761

Note: Not all items are available for all transmissions



ALLISON (M74) LCT 1000/2000/2400

To Get The Correct Parts, You Must Provide The Assembly Number Found On The Transmission Name Plate.

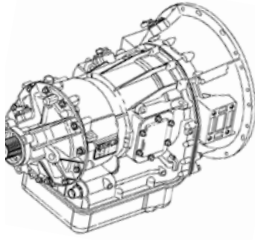

Allison Transmissions
LCT 1000, 2000, 2400



121010



121010A

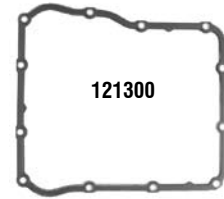

121300

ILL.	DESCRIPTION	QTY.	YEAR	PART NO.	REFERENCE NO.
MASTER OVERHAUL KITS (WITH STEELS)					
006H	Allison 1000, 2000, 2400 (w/ Bonded Pistons)	1	00-05	121006A	K1500
006H	Allison 1000, 2000, 2400 (w/ Bonded Pistons)	1	06-Up	121006B	N/A
LESS STEEL KITS					
004H	Allison 1000, 2000, 2400 (w/ Bonded Pistons)	1	00-05	121004A	K1500-LS
004H	Allison 1000, 2000, 2400 (w/ Bonded Pistons)	1	06-Up	121004B	N/A
OVERHAUL KITS (W/ RINGS & SEALS)					
002H	Allison 1000, 2000, 2400 (w/o Bonded Pistons)	1	00-05	121002	N/A
002H	Allison 1000, 2000, 2400 (w/ Bonded Pistons)	1	00-05	121002A	K15900
002H	Allison 1000, 2000, 2400 (w/ Bonded Pistons)	1	06-Up	121002B	N/A
FILTER KITS					
011I	Filter Kit, Shallow Pan (Black)	1	00-Up	121011	FK15800
011I	Filter Kit, Deep Pan (White)	1	00-Up	121011A	FK15800A
FILTERS					
010I	Shallow Pan (Black)	1	00-Up	121010	15800
010I	Deep Pan (White)	1	00-Up	121010A	15800A
013H	Spin-on External	1	00-Up	121013	14802
BUSHINGS					
030H	Bushing Kit	1	00-Up	121030	K15905
034A	Front Pump Body	1	00-Up	121034	15005
METAL CLAD SEALS					
070A	Front	1	00-Up	121070	15200
074G	Rear	1	00-Up	121074	15850
FRICTION PLATES					
108B	C1 Clutch - External Teeth	6	00-Up	121108	15100
100E	C2 Clutch	6	00-Up	121100	15101
100E	C2 Clutch Z Pack	6	00-Up	121100K	K15101Z
104F	C3 Clutch	4	00-Up	121104	15102
104F	C4 Clutch	5	00-Up	121104	15102
114D	C5 Clutch	6	00-Up	121114	15103
STEEL PLATES					
128B	C1 Clutch - Internal Teeth	6	00-Up	121128	15105
120E	C2 Clutch	7	00-Up	121120	15106
124F	C3 Clutch .098"	3	00-Up	121124	15107
124F	C4 Clutch .098"	4	00-Up	121124	15107
124F	C3 & C4 Apply Plate .125"	1	00-Up	121124A	N/A
134D	C5 Clutch .078"	AR	00-Up	121134A	N/A
134D	C5 Clutch .098"	6	00-Up	121134	15108
134D	C5 Clutch .118"	AR	00-Up	121134B	N/A

ALLISON (M74) LCT 1000/2000/2400

To Get The Correct Parts, You Must Provide The Assembly Number Found On The Transmission Name Plate.

ILL.	DESCRIPTION	QTY.	YEAR	PART NO.	REFERENCE NO.
VALVE BODY RECALIBRATION KITS					
165H	Shift Kit®, Standard, HD and Racing (5 Speeds) (Transgo®).....	1	01-05	T121165	K15908
165H	Junior Shift Kit® (6 Speeds) (Transgo®).....	1	05-Up	T121167	K15908B
GASKETS & O-RINGS					
300I	Gasket, Pan (Bonded Rubber).....	1	00-Up	121300	13200R
309	Seal, Bell Bolt.....	1	00-Up	121309	N/A
311	O-Ring, Pump.....	1	00-Up	121311	N/A
318	Gasket, Bell Housing Plate (Front) (can use 121318B).....	1	00-Up	121318	N/A
318	Gasket, Bell Housing Plate (Front) (2nd Design, Retros 00-Up).....	1	00-Up	121318B	N/A
318	Gasket, Bell Housing Plate (Rear).....	1	00-Up	121318A	N/A
TECHNICAL MANUALS					
400H	Tech Manual.....	1	00-Up	121400	15Y01
400H	Service Manual - OEM.....	1	00-Up	121400M	TM-1000M
400H	Parts Manual - OEM.....	1	00-Up	121400P	TM-1000P
400H	Trouble Shooting Manual - OEM.....	1	00-Up	121400T	TM-1000T
ELECTRICAL COMPONENTS					
410H	Neutral Start/ Backup Switch (MLPS) 2 Connector.....	1	01-E03	121410	15A-199
410H	Neutral Start/ Backup Switch (MLPS) 1 Connector.....	1	L03-Up	121410A	15A-199A
418H	Solenoid, "A" Trim (Normally Closed).....	1	00-Up	121418	5A-198
418H	Solenoid, "B" Trim (Normally Open).....	1	00-Up	121418A	5A-199
418H	Solenoid, "F" Trim (PWM).....	1	00-Up	74418E	5A-187
421H	Solenoid, Shift ("C", "D" & "E").....	3	00-Up	74418EA	5A-192
421H	Solenoid, Modulated Pressure Control ("G").....	1	04-Up	74418EA	5A-192
438H	Sensor, Input, Output & Turbine.....	3	00-Up	121438	20A-199
442H	Switch Assembly, Pressure Manifold.....	1	00-Up	14411A	15D-176
446H	Wiring Harness Assembly (Internal) 6 Solenoids.....	1	01-E03	121446	35A-199
446H	Wiring Harness Assembly (Internal) 7 Solenoids.....	1	L03-Up	121446A	35A-199A
446H	Repair Kit, Park / Neutral Switch Harness.....	1	00-Up	74446K	35A-114K
HARD PARTS					
Prefix Key: D = OEM, A = Aftermarket New, R = Remanufactured					
PUMPS					
510A	Pump Body w/ Gears.....	1	00-Up	121510	N/A
510A	Pump Body Kit (incl Body, Gears, Plate, Bushing & Seal).....	1	00-Up	121510K	15920
PUMP COMPONENTS					
544A	Pump Plate.....	1	00-Up	121544	15922
507H	Pump Kit, Lock-up Boost Kit (00-03).....	1	00-03	121507K	K15888
507H	Pump Kit, Lock-up Boost Kit (04-07).....	1	04-07	121507AK	K15888A
507H	Springs, Lube Reg. / Converter Relief.....	1	00-03	121507A-3	K15882
DRUMS & CLUTCH HUBS					
554A	C1/C2 Drum w/ PTO Gear.....	1	00-Up	121554	15950
570B	C2 Hub.....	1	00-Up	121572	15955
PLANETS					
580C	Planet, Front (P1).....	1	00-Up	121580	15962
582C	Planet, Center (P2).....	1	00-Up	121582	15964
584D	Planet, Rear (P3).....	1	00-Up	121584	15966
590	Ring Gear (P12).....	1	00-Up	121590	N/A
592C	Ring Gear (P2).....	1	00-Up	121592	N/A
594C	Ring Gear (P3).....	1	00-Up	121594	N/A

LCT 1000



NOTES

ALLISON AT540, 543, 545

To Get The Correct Parts, You Must Provide The Assembly Number Found On The Transmission Name Plate.

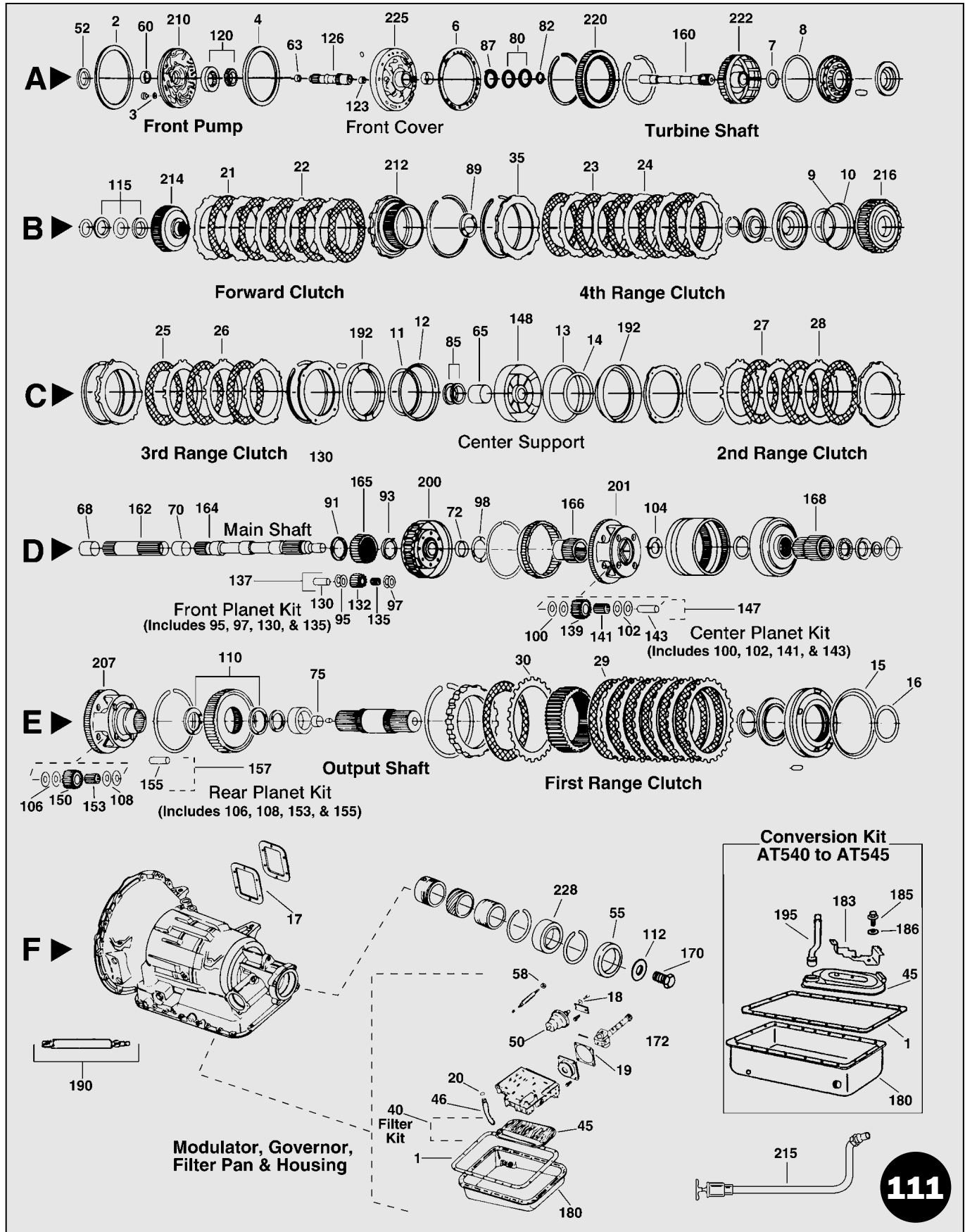

ALLISON AT540, 543, 545

NOTE: Early AT540/545 parts up to serial number 3210775436.
Late AT545 parts from serial number 3210775437.

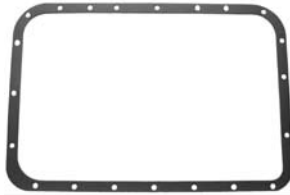

111300

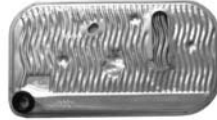

111010B

Allison Transmissions
AT540, 543, 545

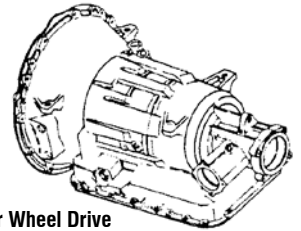

Rear Wheel Drive

ILL.	DESCRIPTION	QTY.	YEAR	PART NO.	REFERENCE NO.
MASTER OVERHAUL KITS (WITH STEELS)					
N.I.	Exc AT543 European (w/ Armstrong® Gasket)	1	70-Up	111006A	K1100
N.I.	AT543 European	1	70-Up	111006B	K1100A
LESS STEEL KITS					
N.I.	Exc AT543 European (w/ Armstrong® Gasket)	1	70-Up	111004A	K1100-LS
N.I.	AT543 European	1	70-Up	111004B	K1100A-LS
OVERHAUL KITS (W/ RINGS & SEALS)					
N.I.	Exc AT543 European (w/ Cork Gasket)	1	70-Up	111002	K11900
N.I.	Exc AT543 European (w/ Armstrong® Gasket)	1	70-Up	111002A	K11900W
N.I.	AT543 European	1	70-Up	111002B	K11900A
FILTER KITS					
40F	Filter Kit (Metal Screen) Cork	1	70-Up	111011B	FK11800
40F	Filter Kit (Treated Paper) Cork	1	70-Up	111011D	FK11800A
40F	Filter Kit (Treated Paper) Armstrong®	1	70-Up	111011E	FK11800AW
40F	Filter Kit (Metal Screen) Armstrong®	1	70-Up	111011C	FK11800W
40F	Filter Kit (Brass Screen) Late AT Deep Pan	1	70-Up	111011	FK34661SW
FILTERS					
45F	Filter (Metal Screen)	1	70-Up	111010B	11800
45F	Filter (Treated Paper)	1	70-Up	111010D	11800A
45F	Filter (545 Update) (Use with 111495B Tube)	1	70-Up	101010	21800
45F	Filter (Brass Screen)	1	70-Up	34010B	34661S
N.I.	External Spin on Cartridge (One Quart)	1	70-Up	111013	PF-897
N.I.	Governor Tube Screen	1	70-Up	111014	11712
BUSHINGS					
N.I.	Bushing Kit (7 Bushings) AT540/Early 545	1	70-Up	111030	K11902
N.I.	Bushing Kit (7 Bushings) Late 545	1	70-Up	111030A	K11902A
60A	Pump Body (Bronze)	1	70-Up	111034B	11005
60A	Pump Body - Babbitt - Updated Version	1	70-Up	44034	8005
63A	Stator (Front) 1.120" OD	1	70-Up	34037	34002
68D	Sun Gear (Front & Rear) 1.120" OD (up to S# 3210775437)	2	70-Up	34037	34002
68D	Sun Gear (Front & Rear) 1.190" OD (S# 3210775438 & Up)	2	70-Up	111037	11007
65C	Center Support (1.540" OD)	1	70-Up	111044	11000
65C	Center Support (1.600 O.D)	1	70-Up	111044A	11000A
72D	Front Planet	1	70-Up	111053	11001
75E	Output Shaft .775" OD (up to S# 3210775437)	1	70-Up	111062	11002
75E	Output Shaft .815" OD (S# 3210775438 & Up)	1	70-Up	111062A	11002A
METAL CLAD SEALS					
52A	Front Pump (Silicone)	1	70-Up	44070B	38151A
52A	Front Pump (Vamac Material)	1	70-Up	44070	38151V
58F	Selector Shaft	1	70-Up	44072	38511
N.I.	Extension Housing	1	70-Up	121074	11850

AT540

ALLISON

AT540, 543, 545

To Get The Correct Parts, You Must Provide The Assembly Number Found On The Transmission Name Plate.

ILL.	DESCRIPTION	QTY.	YEAR	PART NO.	REFERENCE NO.
FRICITION PLATES					
23B	4th Range	5	70-Up	111104	11103
21B	Forward	5	70-Up	111104	11103
27C	2nd Range	3	70-Up	111106	11104
25C	3rd Range	3	70-Up	111106	11104
29E	1st Range	7	70-Up	111108	11106
STEEL PLATES					
28C	2nd Range	3	70-Up	111126	11105
26C	3rd Range	3	70-Up	111126	11105
24B	4th Range	10	70-Up	34126A	34305C
142	4th Range (Backing Plate)	1	70-Up	111142	11763
22B	Forward	10	70-Up	34126A	34305C
N.I.	Forward (Waved)	1	70-Up	111129	11875
30E	1st Range	7	70-Up	111128	11107
MODULATORS					
50F	Modulator (Large Can)	1	70-Up	111160A	11820
50F	Modulator (Small Can)	1	70-Up	111160	11820A
SEALING RINGS					
N.I.	Ring Kit.....	1	70-Up	111175	K11901
82A	Turbine Shaft.....	1	70-Up	111178	11301
80A	Pump.....	2	70-Up	111179	11302
85C	Center Support.....	2	70-Up	111179	11302
THRUST WASHERS & BEARINGS					
N.I.	Washer, Drain Plug (Metal)	1	70-Up	111202	11423
N.I.	Washer, Drain Plug (Coated).....	1	70-Up	111202A	11423B
N.I.	Bearing / Race Kit	1	70-Up	101203K	11500BK
87A	Roller Bearing, Ground Sleeve	1	70-Up	101211	11221
87A	Washer, Front Pump (.056"-.060") # 0.....	AR	70-Up	111211A	11407
87A	Washer, Front Cover (.089"-.093") # 2.....	AR	70-Up	111211C	11407B
87A	Washer, Front Cover (.105"-.109") # 3.....	AR	70-Up	111211D	11407C
87A	Washer, Front Cover (.121"-.125") # 4.....	AR	70-Up	111211E	11407D
87A	Washer, Front Cover (.138"-.142") # 5.....	AR	70-Up	111211F	11407E
N.I.	Spacer, Turbine, .015" Gold (AT543).....	AR	70-Up	111212	11403
N.I.	Spacer, Turbine, .030" Silver (AT543)	AR	70-Up	111212A	11403A
N.I.	Spacer, Turbine, .042" Plain (AT543)	AR	70-Up	111212B	11403B
N.I.	Spacer, Turbine, .060" Black (AT543)	AR	70-Up	111212C	11403C
N.I.	Spacer, Turbine, .075" Copper (AT543).....	AR	70-Up	111212D	11403D
115B	Bearing Package, Forward Hub, Front (3 Piece)	1	70-Up	111231K	11503BK
89B	Washer, Fourth Clutch Driving Hub	1	70-Up	34235	34301
N.I.	Washer, Front Planetary, Rear Carrier	1	70-Up	111238	11415
91D	Washer, Front Sun Gear, Front (up to S# 3210775436)	1	70-Up	111241	11411
91D	Washer, Front Sun Gear, Front (S# 3210775437 & Up)	1	70-Up	111241A	11411A
93D	Washer, Front Sun Gear, Rear, .064-.068", Color Code Red	AR	70-Up	111242	11412
104D	Washer, Center Planetary, Rear Carrier (up to S# 3210775436)	1	70-Up	111250C	11418
104D	Washer, Center Planetary, Rear Carrier (S# 3210775437 & Up)	1	70-Up	111244	11418A
100D	Washer, Center Planetary, Bronze Pinion	8	70-Up	111250A	11416
102D	Washer, Center Planetary, Steel Pinion	8	70-Up	111250B	11417
100D	Washer, Rear Planetary, Bronze Pinion.....	8	70-Up	111250A	11416
102D	Washer, Rear Planetary, Steel Pinion.....	8	70-Up	111250B	11417
N.I.	Bearing, Rear Output to Case.....	1	70-Up	111263	N/A
N.I.	Bearing, Output (up to S# 3210775436).....	1	70-Up	111268	11925
N.I.	Bearing, Output (S# 3210775437 & Up).....	1	70-Up	111268A	11925A
N.I.	Roller Bearing, Converter Stator, 543.....	1	70-Up	111299A	11404

To Get The Correct Parts, You Must Provide The Assembly Number Found On The Transmission Name Plate.

ILL.	DESCRIPTION	QTY.	YEAR	PART NO.	REFERENCE NO.
GASKETS & O-RINGS					
1F	Gasket, Bottom Pan (Armstrong®).....	1	70-Up	111300A	13540W
1F	Gasket, Bottom Pan (Cork).....	1	70-Up	111300	13540X
19F	Gasket, Governor Cover.....	1	70-Up	34306	3914D
19F	Gasket, Governor Cover (Armstrong®).....	1	70-Up	111306	3914LW
3A	Seal / Washer, Front Pump Body Bolt.....	9	70-Up	44309	13268A
6A	Gasket, Pump to Case.....	1	70-Up	111310	13153
2A	Lathe Cut O-Ring, Pump Body.....	1	70-Up	111311	13151
2A	Lathe Cut O-Ring, Pump Body (GM 350 Style).....	1	70-Up	44311	3877L
4A	Lathe Cut Seal, Front Pump Support.....	1	70-Up	111311	13152
17F	Gasket, Power Take Off Cover (Update) Armstrong®.....	1	70-Up	111319	13158W
17F	Gasket, Power Take Off Cover.....	1	70-Up	111319	13158W
N.I.	Gasket, Converter Pump Hub (AT543 w/ Bolt On Hub).....	1	70-Up	111323	13150W
20F	O-Ring, Oil Filter.....	1	70-Up	12368A	3547L
N.I.	Front Pump Re-Seal Kit (pump gasket, lathe-cut seal, O-ring and bolt washers).....	1	70-Up	111390	K11900-2
TECHNICAL MANUALS					
N.I.	Service Manual.....	1	70-Up	111400M	N/A
N.I.	Parts Catalog.....	1	70-Up	111400P	N/A
ELECTRICAL COMPONENTS					
N.I.	Switch, Reverse Signal / Backup Light (AS36-033).....	1	70-Up	111414	11610
N.I.	Tube & Dip Stick Assembly (Universal).....	1	70-Up	111494U	11999U
195F	Tube, Oil Filter (AT545 Update, use w/ 101010 Filter).....	1	70-Up	111495B	21225A
HARD PARTS					
Prefix Key: D = OEM, A = Aftermarket New, R = Remanufactured					
PUMPS					
210A	Pump Body & Gears (Universal).....	1	70-Up	A34510	34200CN
210A	Pump Body & Gears (AT540) Body Cast #895.....	1	70-Up	111510	34200C
210A	Pump Body & Gears (AT545) Body Cast #919.....	1	70-Up	111510A	34200D
225A	Support, Front Pump (6 Bolt) (AT540) Body Cast #895.....	1	70-Up	111520	11921
225A	Support, Front Pump (7 Bolt) (AT545) Body Cast #919.....	1	70-Up	111520A	11921B
120A	Gear Kit, Front Pump .727" Thick.....	1	70-Up	111530	K11201
120A	Gear Kit, Front Pump (Oversized).....	1	70-Up	111530-OS	K11201B
DRUMS & CLUTCH HUBS					
216B	Housing, 4th Clutch (up to serial # 3210775436).....	1	70-Up	111553	11769
216B	Housing, 4th Clutch (from serial # 3210775437).....	1	70-Up	111553A	11769A
222A	Housing, Forward Clutch (w/o Turbine Shaft) (up to serial # 3210775436).....	1	70-Up	111554	11298
222A	Housing, Forward Clutch (w/ Turbine Shaft) (serial # 3210775437 & Up).....	1	70-Up	111554A	11298B
214B	Hub, Forward Clutch (up to serial # 3210775436).....	1	70-Up	111574	11634
214B	Hub, Forward Clutch (from serial # 3210775437).....	1	70-Up	111574A	11634A
212B	Hub, 4th Clutch (up to serial # 3210775436).....	1	70-Up	111578	11732
212B	Hub, 4th Clutch (from serial # 3210775437).....	1	70-Up	111578A	11732A
PLANETS					
201D	Center Planet.....	1	70-Up	111580	11676
200D	Front Planet.....	1	70-Up	111582	11768
207E	Rear Planet.....	1	70-Up	111584	11719
147D	Kit - Center Planetary Repair.....	4	70-Up	111584-7K	K11216
137D	Kit - Front Planetary Repair.....	1	70-Up	111582-7	K11215
157E	Kit - Rear Planetary Repair.....	1	70-Up	111584-7K	K11216
135D	Needle Roller - Center Planetary.....	76	70-Up	111584-4	11920
141D	Needle Roller - Front Planetary.....	80	70-Up	111582-4	11919

AT540

ALLISON

AT540, 543, 545

To Get The Correct Parts, You Must Provide The Assembly Number Found On The Transmission Name Plate.

ILL.	DESCRIPTION	QTY.	YEAR	PART NO.	REFERENCE NO.
PLANETS (Cont.)					
153E	Needle Roller - Rear Planetary	76	70-Up	111584-4	11920
143D	Pin - Center Planetary	4	70-Up	111584-3	11216
130D	Pin - Front Planetary.....	4	70-Up	111582-3	11215
155E	Pin - Rear Planetary	4	70-Up	111584-3	11216
95D	Washer - Front Planetary - Bronze - Pinion Gear	8	70-Up	111582-1A	11413
97D	Washer - Front Planetary - Steel - Pinion.....	8	70-Up	111582-1B	11414
SUN GEARS, SHELLS & SUPPORTS					
166D	Sun Gear, Center (up to S# 3210775436).....	1	70-Up	111610	11227
166D	Sun Gear, Center (S# 3210775437 & Up).....	1	70-Up	111610B	11227B
165D	Sun Gear, Front (Up to S# 3210775436).....	1	70-Up	111612	11232
165D	Sun Gear, Front (S# 3210775437 & Up).....	1	70-Up	111612A	11232A
168D	Sun Gear, Rear (Up to S# 3210775436).....	1	70-Up	111614	11228
168D	Sun Gear, Rear (S# 3210775437 & Up).....	1	70-Up	111614A	11228A
148C	Center Support (up to S# 3210775436).....	1	70-Up	111630	11229
148C	Center Support (S# 3210775437 & Up).....	1	70-Up	111630A	11229A
SHAFTS					
164D	Shaft, Main 1.000" Journal (up to S# 3210775436).....	1	70-Up	111672	11226
164D	Shaft, Main 1.060" Journal (up to S# 3210775437.).....	1	70-Up	111672C	11226A
164D	Shaft, Main - Reinforced - 1.060 Journal - Late (S# 3210775437 & Up).....	1	70-Up	111672A	11226B
160A	Turbine Shaft (Up to S# 3210775436).....	1	70-Up	111673	11939
160A	Turbine Shaft (From S# 3210775437).....	1	70-Up	111673B	11939B
162D	Shaft, Sun Gear (Up to S# 3210775436).....	1	70-Up	111674	11225
162D	Shaft, Sun Gear (From S# 3210775437).....	1	70-Up	111674A	11225A
GOVERNORS					
172F	Governor (Code # 460) 3600-3800 RPM Range.....	1	70-Up	111680	11410
172F	Governor (Code # 461) Up to 2800 RPM Range.....	1	70-Up	111680A	11410A
172F	Governor (Code # 462) 3000-3400 RPM Range.....	1	70-Up	111680B	11410B
N.I.	Gear, Governor Gear Kit.....	1	70-Up	34684B	K34411A
MISCELLANEOUS COMPONENTS					
170F	Bolt, Output Flange (23014159)	1	70-Up	111790	11222
N.I.	Bolt, Pan	21	70-Up	111779	96-175A
N.I.	Bolt, Torque Converter (1261968).....	3-6	70-Up	M464GE	96-178
N.I.	Bolt, Use w/ Update Bracket (For Conversion Kit 540 to 545).....	1	70-Up	111794	11548
N.I.	Bracket, Updated (For Conversion Kit 540 To 545).....	1	70-Up	111794B	11546
N.I.	Check Ball (1/4").....	1	70-Up	A76741A-5	13924
N.I.	Check Ball (5/16").....	1	70-Up	76741-5	13924A
N.I.	Drain Plug (Oil Pan).....	1	70-Up	111483	DP-789
N.I.	Gear, P.T.O.	1	70-Up	111825	11145
190F	Kit, Manual Selector Shaft	1	70-Up	101991	K11235
N.I.	Lock Nut, Second Clutch Spring Retainer (Push On)	4	70-Up	111799	11213
N.I.	Lock Nut, Third Clutch Spring Retainer (Push On)	4	70-Up	111799	11213
N.I.	Nut, Flex Disc (AT543)	6	70-Up	101795C	21214
N.I.	Strip Lock - Converter Pump Hub - 543.....	4	70-Up	101088A	11212
180F	Oil Pan, Deep (Even Threaded Inlets)	1	70-Up	111765	11545A
180F	Oil Pan, Deep (Offset Threaded Inlets).....	1	70-Up	111765A	11545
192C	Piston, Center Support.....	2	70-Up	111962	11817
N.I.	Plug, Cooling Line Ports (Pkg of 100).....	1	70-Up	M479-1	PL1
N.I.	Plug, Speedo Bore (Pkg of 100).....	1	70-Up	M479-2	PL2
N.I.	Plug, Modulator Bore (Pkg of 100).....	1	70-Up	M479-5	PL5
N.I.	Sleeve, Center Support Repair (Early).....	1	70-Up	191695A	DF636B

ALLISON AT540, 543, 545

To Get The Correct Parts, You Must Provide The Assembly Number Found On The Transmission Name Plate.

ILL.	DESCRIPTION	QTY.	YEAR	PART NO.	REFERENCE NO.
MISCELLANEOUS COMPONENTS (Cont.)					
126A	Sleeve, Ground (Finished I.D. Bearing Inst.)	1	70-Up	111695AK	11202
N.I.	Washer, Center Support Bolt.....	1	70-Up	111783W	11422
112F	Washer, Output Flange Bolt.....	1	70-Up	111790W	11421
N.I.	Washer, Use w/ Update Bracket (For Conversion Kit 540 to 545).....	1	70-Up	111794W	11547
Tool	Governor Sleeve Only - Aluminum (Aluminum Case).....	1	70-Up	T-119A	T-119A
Tool	Governor Sleeve Only - Bronze (Cast Iron Case)	1	70-Up	T-119B	T-119B
Tool	Governor Bore Tool (w/ 2 Sleeves)	1	70-Up	T-9119	T-9119
Tool	Conversion Kit (Deep Pan) AT540 to AT545	1	70-Up	UDK-545	UDK-545

GOVERNOR APPLICATION CHART

TRANSMISSION	CODE ON GOVERNOR	USE GOVERNOR NO.
AT 500 SERIES		
Up to and including - 2800 RPM Range	461	111680A
3000 - 3400 RPM Range	462	111680B
Gas Engine - 3600 - 3800 RPM Range	460	111680
AT643		
2200 - 2600 RPM Range	461	111680A
3000 - 3400 RPM Range	463	101680
MT653		
2400 - 2600 RPM Range	462	111680B
2800 RPM Range.....	463	101680
3000 RPM Range.....	465	101680A
3200 - 3800 RPM Range - Bronze Gear	738	101680B
3600 - 3800 RPM Range - Bronze Gear	739	101680C
Caterpillar Engine w/Blower - 2600 RPM Range.....	-	101680B
Caterpillar Engine w/o Blower - 2800 RPM Range.....	-	101680C

NOTES

AT540

ALLISON MT/B 640, 643, 644, 647, 650, 653, 654

To Get The Correct Parts, You Must Provide The Assembly Number Found On The Transmission Name Plate.

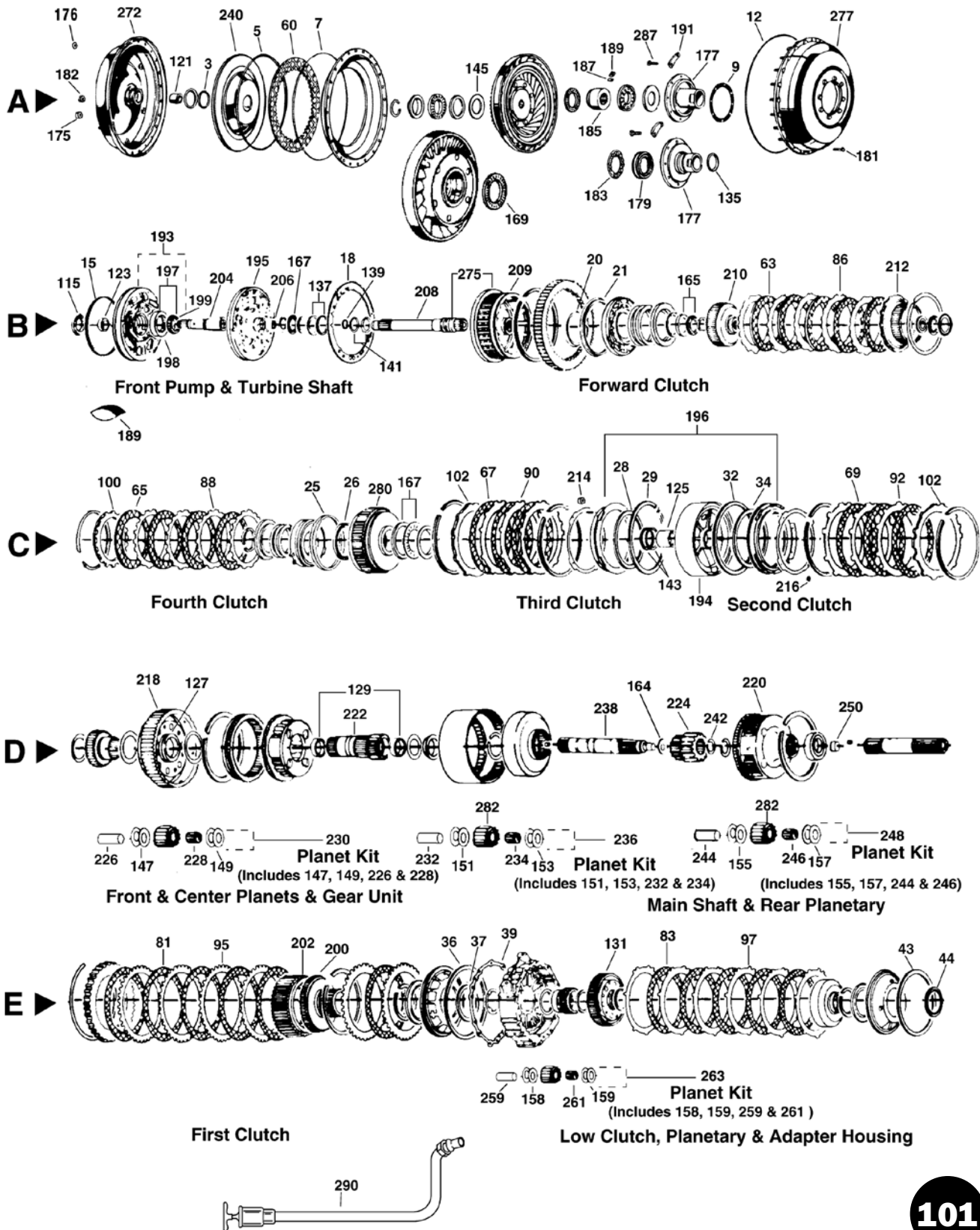

ALLISON

MT/B 640, 643, 644, 647, 650, 653, 654

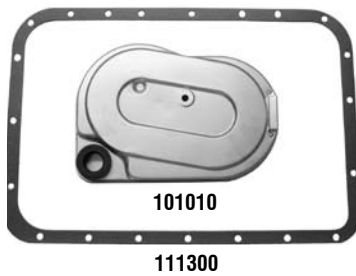
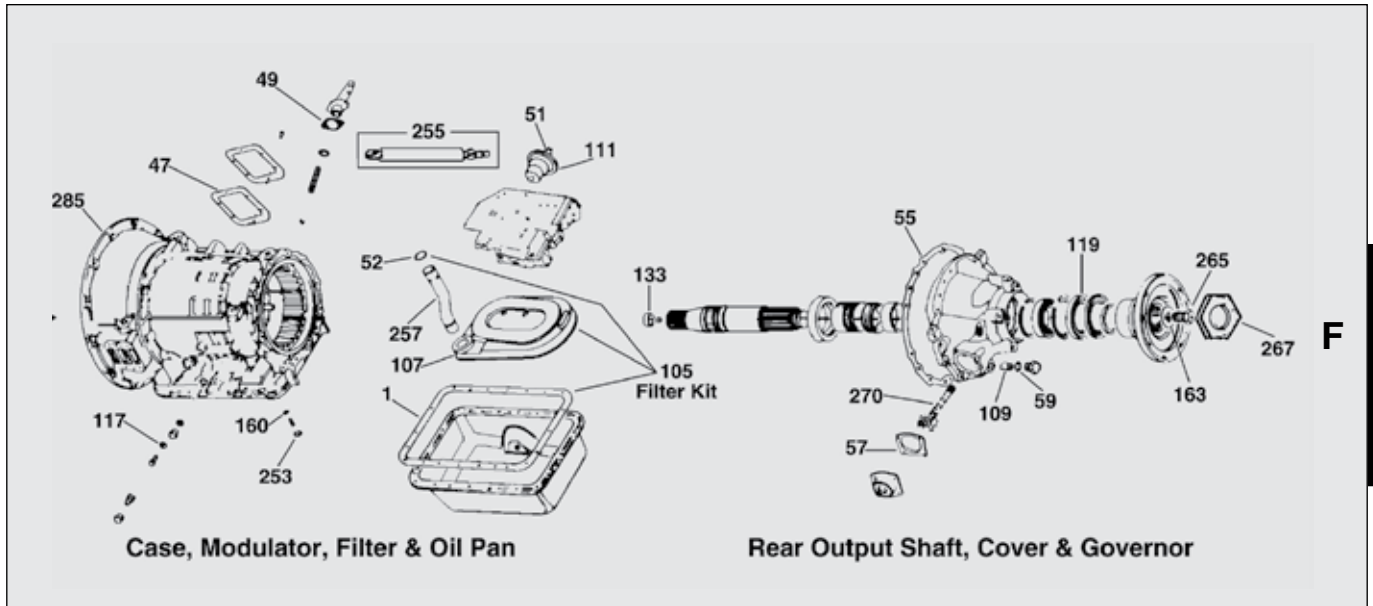

Allison Transmissions
MT/B 640, 643, 644, 647, 650, 653, 654

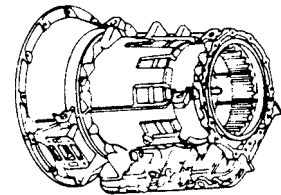

To Get The Correct Parts, You Must Provide The Assembly Number Found On The Transmission Name Plate.

ILL.	DESCRIPTION	QTY.	YEAR	PART NO.	REFERENCE NO.
MASTER OVERHAUL KITS (WITH STEELS)					
N.I.	MT640, 643 (Armstrong® & Vespel Rings).....	1	72-Up	101006	K2100
N.I.	MT650, 653 (Armstrong® & Vespel Rings).....	1	72-Up	101006A	K2100A
N.I.	MT644 PH1, PH2.....	1	72-Up	101006D	K2100B
N.I.	MT654 PH1, PH2.....	1	72-Up	101006E	K2100D
LESS STEEL KITS					
N.I.	MT640, 643 (Armstrong® & Vespel Rings).....	1	72-Up	101004	K2100-LS
N.I.	MT650, 653 (Armstrong® & Vespel Rings).....	1	72-Up	101004A	K2100A-LS
N.I.	MT644 PH1, PH2.....	1	72-Up	101004D	K2100B-LS
N.I.	MT654 PH1, PH2.....	1	72-Up	101004E	K2100D-LS
OVERHAUL KITS (W/ RINGS & SEALS)					
N.I.	MT640, 643, 650, 653 (Armstrong® & Vespel Rings).....	1	72-Up	101002A	K21900FW
N.I.	MT644, 654 (Cork & Standard Rings)	1	72-Up	101002D	K21900B
N.I.	MT644, 654 (Armstrong® & Vespel Rings).....	1	72-Up	101002H	K21900HW
FILTER KITS					
105F	Filter Kit, Cork & Neoprene	1	72-Up	101011	FK21800
105F	Filter Kit, Armstrong® (Large Hole Grommet).....	1	72-Up	101011A	FK21800W
105F	Filter Kit, Armstrong® (Small Hole Grommet).....	1	72-Up	101011B	FK21800AW
105F	Filter Kit, Stainless Steel Wire Mesh (5" Pan)..... (Use w/ Auxiliary Filter Only)	1	72-Up	101011C	FK21800L

MT640

ALLISON

MT/B 640, 643, 644, 647, 650, 653, 654

To Get The Correct Parts, You Must Provide The Assembly Number Found On The Transmission Name Plate.

ILL.	DESCRIPTION	QTY.	YEAR	PART NO.	REFERENCE NO.
FILTERS					
107F	Paper (Large Hole Grommet).....	1	72-Up	101010	21800
107F	Paper (Small Hole Grommet).....	1	72-Up	101010B	21800A
107F	Stainless Steel Wire Mesh (5" Pan)..... (Use w/ Auxiliary Filter Only)	1	72-Up	101010C	21800L
N.I.	External Spin on Cartridge.....	1	72-Up	101013	HD-223
109F	Screen, Governor (Early up to S# 58071).....	1	72-Up	101014	21712
109F	Screen, Governor (Late S# 58071 & up).....	1	72-Up	111014	11712
N.I.	Screen, Center Support.....	1	72-Up	101017	21713
BUSHINGS					
N.I.	Bushing Kit	1	72-Up	101030	K21902
123B	Pump (2.443" OD).....	1	72-Up	101034	21005
123B	Pump (2.530" OD).....	1	72-Up	101034A	21007
123B	Pump (2.580" OD).....	1	72-Up	101034B	21008
125C	Center Support.....	1	72-Up	101044	21003
129D	Center Sun Gear (Finish In Place)	2	72-Up	101052	21002
129D	Center Sun Gear (Unfinished In Place)	2	72-Up	101052A	21002X
127D	Front Planet Carrier (Finish In Place).....	1	72-Up	101053	21001
131E	Low Planetary Carrier (ID Must Be Finished In Place).....	1	72-Up	101059	21004
133F	Rear Output Shaft (Replaces Bearing In Rear Output Shaft).....	1	72-Up	101062	21006
METAL CLAD SEALS					
115B	Front Pump (3.335" OD)	1	72-Up	101070	21200
115B	Front Pump (3.380" OD) (Viton Shielded)	1	72-Up	101070A	21200B
115B	Front Pump (3.881" OD) (Update, Brown)	1	72-Up	101070B	21200A
117F	Selector Shaft	1	72-Up	44072	38511
119F	Extension Housing (3.628" OD).....	1	72-Up	121074	11850
119F	Extension Housing (4.751" OD).....	1	72-Up	101080	21850
FRICTION PLATES					
81E	1st.....	6	72-Up	111106	11104
69C	2nd.....	3-4	72-Up	101106	21104
67C	3rd	3	72-Up	101106	21104
65C	4th.....	4-5	72-Up	101108	21103
63B	Forward	5-6	72-Up	101108	21103
83E	Low (50 T) (Exc 654 Phase 1 & 2).....	6	72-Up	101106	21104
83E	Low (71 T) (654 Phase 1 & 2)	7	72-Up	101106A	21101
STEEL PLATES					
95E	1st.....	6	72-Up	101124	21107
92C	2nd.....	3-4	72-Up	101126	21105
90C	3rd	3	72-Up	101126	21105
88C	4th.....	4-5	72-Up	101128	21100
86B	Forward	5-6	72-Up	101128	21100
97E	Low (8.825" ID) (Exc 654 Phase 1 & 2)	6-7	72-Up	101126	21105
97E	Low (9.198" ID) (654 Phase 1 & 2).....	8	72-Up	101126B	21102
BACKING PLATES					
100C	4th Clutch	1	72-Up	101142	21108
102C	2-3 Clutch (.450"-.460")	AR	72-Up	101148C	21746
102C	2-3 Clutch (.463"-.473")	AR	72-Up	101148A	21718
102C	2-3 Clutch (.476"-.486")	AR	72-Up	101148B	21745

ALLISON

MT/B 640, 643, 644, 647, 650, 653, 654

To Get The Correct Parts, You Must Provide The Assembly Number Found On The Transmission Name Plate.

ILL.	DESCRIPTION	QTY.	YEAR	PART NO.	REFERENCE NO.
MODULATORS					
111F	Modulator w/ O-Ring (Small Can)	1	72-Up	111160	11820A
111F	Modulator w/ O-Ring (Large Can)	1	72-Up	111160A	11820
SEALING RINGS					
N.I.	Ring Kit (Complete 8 Rings)	1	72-Up	101175	K21901
N.I.	Ring Kit (Complete 8 Rings) (Vespel)	1	72-Up	101175A	K21901V
N.I.	Ring Kit (Pump Support, Front Vespel)	1	72-Up	101175D	K21301V
137B	Pump Support (Front)	2	72-Up	101176	21301T
143C	Center Support	2	72-Up	101176	21301T
141B	Turbine Shaft (Front)	2	72-Up	101178	21303
139B	Turbine / Converter	1	72-Up	101181	21302
139B	Turbine / Converter (Vespel)	1	72-Up	101181V	21302V
THRUST WASHERS & SPACERS					
N.I.	Washer, Drain Plug (Coated)	1	72-Up	111202A	11423B
147D	Washer, Front Planet (Bronze)	12	72-Up	111582-1A	11413
149D	Washer, Front Planet (Steel)	12	72-Up	111582-1B	11414
151D	Washer, Center Planet (Bronze)	8	72-Up	101250A	21415
153D	Washer, Center Planet (Steel)	8	72-Up	101250B	21416
155D	Washer, Rear Planet (Bronze)	8	72-Up	101250A	21415
157D	Washer, Rear Planet (Steel)	8	72-Up	101250B	21416
158E	Washer, Low Planet (Bronze) (Exc 644, 654)	12	72-Up	111250A	11416
159E	Washer, Low Planet (Steel) (644, 654)	8	72-Up	101250D	21424
160F	Washer, Center Support Bolt	1	72-Up	111783W	11422
163F	Washer, Output Flange	1	72-Up	111790W	11421
164D	Washer, Rear Sun Gear (Plastic)	1	72-Up	101247	21418
BEARINGS & RACES					
N.I.	Bearing Kit (101299 not included)	1	72-Up	101201	K21950
N.I.	Bearing Kit, Complete 643	1	72-Up	101201C	K21950C
N.I.	Bearing Kit, Complete 653	1	72-Up	101201D	K21950D
206B	Roller Bearing, Front Pump (Ina Brand)	1	72-Up	111211N	21223A
206B	Roller Bearing, Front Pump (Torrington)	1	72-Up	111211M	21223
167B	Front & Center Support	2	72-Up	12214	21782
165B	Forward Clutch	2	72-Up	101235	21799
250D	Roller Bearing, Output Shaft 640, 643	1	72-Up	101268	21219
GASKETS & O-RINGS					
1F	Gasket, Pan Gasket (Cork)	1	72-Up	111300	13540X
1F	Gasket, Pan Gasket (Armstrong®)	1	72-Up	111300A	13540W
39E	Gasket - Adapter Housing	1	72-Up	101303	13171
55F	Gasket - Rear Cover	1	72-Up	101303	13171
57F	Gasket, Governor Cover	1	72-Up	34306	3914D
57F	Gasket, Governor Cover (Updated)	1	72-Up	111306	3914LW
47F	Gasket, PTO Cover (Update - Armstrong®)	1	72-Up	111319	13158W
52F	O-Ring, Oil Filter Tube (Polyacrylate)	1	72-Up	101363	3435PL
51F	O-Ring, Modulator	1	72-Up	44369B	3410L
59F	O-Ring, Governor Filter & Cooler Fitting	1-2	72-Up	34370	13173
N.I.	O-Ring, Center Support (Starting With Serial No. 100432)	1	72-Up	101372	13172
N.I.	External Reseal Kit, Front Pump	1	72-Up	101390	K21900-2
49F	Gasket, Lube Valve Adapter	1	72-Up	101398	13166
N.I.	Washer, Drain Plug (Coated)	1	72-Up	111202A	11423B
N.I.	Washer, Cover (Coated)	1	72-Up	101249A	21154

MT640

ALLISON MT/B 640, 643, 644, 647, 650, 653, 654

To Get The Correct Parts, You Must Provide The Assembly Number Found On The Transmission Name Plate.

ILL.	DESCRIPTION	QTY.	YEAR	PART NO.	REFERENCE NO.
TECHNICAL MANUALS					
N.I.	Service Manual (643, 653).....	1	72-Up	101400AM	TM-600M
N.I.	Service Manual (644, 654).....	1	72-Up	101400BM	TM-644M
N.I.	Parts Catalog (643, 653).....	1	72-Up	101400AP	TM-600P
N.I.	Parts Catalog (644, 654).....	1	72-Up	101400BP	TM-644P
HARD PARTS					
Prefix Key: D = OEM, A = Aftermarket New, R = Remanufactured					
PUMPS					
193B	Pump Body w/ .683" Gears Early 640, 650 (29527499 or 23046636)	1	72-Up	101510	K21636
193B	Pump Body w/ .683" Gears Late 640, 650 (29527490 or 23016889)	1	72-Up	101510A	K21636A
193B	Pump Body w/ .818" Gears Early 654 (29527509 or 23046638)	1	72-Up	101510B	K21637
193B	Pump Body w/ 1.000" Gears Late 644, 647, 654 (29527481 or 23017114)	1	72-Up	101510C	K21637A
195B	Pump Support Early 643, 653 (29515355 or 23015871).....	1	72-Up	101520	21871
195B	Pump Support Late 643, 653 (29514491 or 23016751).....	1	72-Up	101520A	21751
195B	Pump Support Early 644, 654 (23015872).....	1	72-Up	101520B	21872
195B	Pump Support Late 644, 654 (23016763).....	1	72-Up	101520D	21763
PUMP GEARS					
197B	Pump Gears (.683") Exc 644, 654	1	72-Up	101530	K21201
197B	Pump Gears (.818") 644, 654	1	72-Up	101530A	K21201C
197B	Pump Gears (1.000") 647	1	72-Up	101530D	K21201D
199B	Inner Gear (.683") Exc 644, 654	1	72-Up	101532A	21201-1
199B	Inner Gear (.683" w/ .060" Oversize OD) Exc 644, 654	1	72-Up	101532AH	21201-3
199B	Inner Gear (.818") 644, 654	1	72-Up	101532B	21201-6
199B	Inner Gear (.818" w/ .060" Oversize OD) 644, 654.....	1	72-Up	101532BH	21201-8
199B	Inner Gear (1.000") 647	1	72-Up	101532C	21201-10
199B	Inner Gear (1.000" w/ .060" Oversize OD) 647	1	72-Up	101532CH	21201-12
198B	Outer Gear (.683") Exc 644, 654	1	72-Up	101534A	21201-2
198B	Outer Gear (.683" w/ .060" Oversize OD) Exc 644, 654	1	72-Up	101534AH	21201-4
198B	Outer Gear (.818") 644, 654.....	1	72-Up	101534B	21201-7
198B	Outer Gear (.818" w/ .060" Oversize OD) 644, 654	1	72-Up	101534BH	21201-9
198B	Outer Gear (1.000") 647.....	1	72-Up	101534C	21201-11
198B	Outer Gear (1.000" w/ .060" Oversize OD) 647	1	72-Up	101534CH	21201-13
DRUMS & CLUTCH HUBS					
209B	Housing, Forward (w/o Shaft) 643, 653	1	72-Up	101551-1	21172
280C	Housing, 4th Clutch 643, 653.....	1	72-Up	101558	21825
280C	Housing, 4th Clutch 644, 654.....	1	72-Up	101558A	21257
210B	Hub, Forward Clutch Exc 644, 654	1	72-Up	101574	21222
212B	Hub, Fourth Clutch Driving Exc 644, 654	1	72-Up	101578	21221
212B	Hub, Fourth Clutch Driving 644, 654	1	72-Up	101578A	21221B
PLANETS					
218D	Front Carrier Replacement Housing w/6 Pins	1	72-Up	101582	RH21565
220D	Rear Carrier 653	1	72-Up	101584A	21642
282D	Gears, Pinion Center / Rear 643, 653 (4 Per Set)	1	72-Up	101584-2	21804
236D	Kit, Center Planet Repair	1	72-Up	101584-7K	K21216
230D	Kit, Front Planet Repair	1	72-Up	101584-7	K21215
263E	Kit, Low Planet Repair Exc 644, 654.....	1	72-Up	101584-7A	K21217
263E	Kit, Low Planet Repair 644, 654	1	72-Up	101584-7B	K21211A
248D	Kit, Rear Planet Repair.....	1	72-Up	101584-7K	K21216
234D	Needle Roller, Center Planet.....	72	72-Up	181585-4A	21920
228D	Needle Roller, Front Planet.....	120	72-Up	111582-4	11919
261E	Needle Roller, Low Planet Exc 644, 654.....	114	72-Up	111584-4	11920
261E	Needle Roller, Low Planet 644, 654	124	72-Up	181585-4A	21920

ALLISON

MT/B 640, 643, 644, 647, 650, 653, 654

To Get The Correct Parts, You Must Provide The Assembly Number Found On The Transmission Name Plate.

ILL.	DESCRIPTION	QTY.	YEAR	PART NO.	REFERENCE NO.
PLANETS (Cont.)					
246D	Needle Roller, Rear Planet.....	72	72-Up	181585-4A	21920
N.I.	Pins, Front Carrier Replacement	6	72-Up	101582-3	565P
226D	Pins, Front Planet	6	72-Up	111582-3	11215
232D	Pins, Center Planet.....	4	72-Up	101585-3	21216
259E	Pins, Low Planet Exc 644, 654.....	6	72-Up	111584-3	11216
259E	Pins, Low Planet 644, 654	4	72-Up	101589-3	21211A
244D	Pins, Rear Planet.....	4	72-Up	101585-3	21216
202E	Ring Gear, 1st Clutch 653.....	1	72-Up	101594	21568
200E	Ring Gear Hub (Hardened) 653	1	72-Up	101604	21325
SUN GEARS, SHELLS & SUPPORTS					
222D	Sun Gear, Center w/ Bushings Installed.....	1	72-Up	101610	21606
224D	Sun Gear, Rear	1	72-Up	101614	21901
194C	Support, Center (w/ Bushing).....	1	72-Up	101630	21940
N.I.	Spring & Roller Kit, Converter Stator (10 Springs & Rollers).....	1	72-Up	111659	K11250
SHAFTS					
238D	Main Shaft 643, 653	1	72-Up	101672	21456
238D	Main Shaft 644, 654	1	72-Up	101672A	21456B
208B	Turbine Shaft Exc 654	1	72-Up	101673	21785
208B	Turbine Shaft 654.....	1	72-Up	101673A	21785B
GOVERNORS					
270F	Governor (Code # 461) 2200-2600 RPM Range 643.....	1	72-Up	111680A	11410A
270F	Governor (Code # 463) 3000-3400 RPM Range 643	1	72-Up	101680	21410
270F	Governor (Code # 462) 2400-2600 RPM Range 653.....	1	72-Up	111680B	11410B
270F	Governor (Code # 463) 2800 RPM Range 653	1	72-Up	101680	21410
270F	Governor (Code # 465) 3000 RPM Range 653	1	72-Up	101680A	21410A
270F	Governor (Code # 738) 3200-3800 RPM Range 653 (Bronze Gear).....	1	72-Up	101680B	21410B
270F	Governor (Code # 739) 3600-3800 RPM Range 653 (Bronze Gear).....	1	72-Up	101680C	21410C
270F	Governor (Caterpillar Engine w/ Blower) 2600 RPM Range	1	72-Up	101680B	21410B
270F	Governor (Caterpillar Engine w/o Blower) 2800 RPM Range.....	1	72-Up	101680C	21410C
N.I.	Kit, Governor Gear (Exc Bronze)	1	72-Up	34684B	K34411A
CASES & HOUSINGS					
285F	Main Case.....	1	72-Up	101760	650M-CASE
MISCELLANEOUS COMPONENTS					
N.I.	Reverse Signal Switch, Backup Light.....	1	72-Up	111414	11610
204B	Ground Sleeve 640, 650 Silver Single Spline w/o Step	1	72-Up	101449	21202
204B	Ground Sleeve 640, 650 Silver Single Spline w/ Step	1	72-Up	101449A	21202A
204B	Ground Sleeve 644, 654 Silver Dual Spline w/o Step.....	1	72-Up	101449B	21203
204B	Ground Sleeve 644, 654 Black Dual Spline w/ Step.....	1	72-Up	101449C	21203A
N.I.	Drain Plug, Oil Pan	1	72-Up	111483	DP-789
290E	Tube & Dip Stick Assembly, Universal.....	1	72-Up	111494U	11999U
257F	Tube, Oil Filter (Updates Prior To S# 58071)	1	72-Up	101495	21225
N.I.	Sleeve, Front Pump Support 640.....	1	72-Up	101695E	21870
N.I.	Support Repair Sleeve, Center 643	1	72-Up	101695A	DF593B
253F	Bolt, Case To Center Support (Anchor 2-1/4").....	1	72-Up	101783	21220
253F	Bolt, Case To Center Support (Anchor 3")	1	72-Up	181783	31220
265F	Bolt, Output Flange.....	1	72-Up	111790	11222
267F	Nut, Self-lock Hex - Rear Output Shaft	1	72-Up	101798	21956
214C	Lock Nut, Third Clutch Spring Retainer (Push On)	4	72-Up	111799	11213

MT640











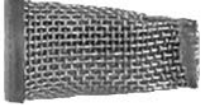



ALLISON

MT/B 640, 643, 644, 647, 650, 653, 654

To Get The Correct Parts, You Must Provide The Assembly Number Found On The Transmission Name Plate.

ILL.	DESCRIPTION	QTY.	YEAR	PART NO.	REFERENCE NO.
MISCELLANEOUS COMPONENTS (Cont.)					
216C	Lock Nut, Second Clutch Spring Retainer (Push On)	4	72-Up	111799	11213
242D	Spiral Ring - Rear Sun Gear To Planetary	1	72-Up	101888	21224
196C	Piston, 2-3 640, 650	1	72-Up	101965	21942
255F	Manual Selector Shaft Kit	1	72-Up	101991	K11235
N.I.	Plug, Cooling Line Ports MT600	2	72-Up	M479-3	PL3
N.I.	Plug, Oil Pan Fill Tube MT600 (Pkg of 100)	1	72-Up	M479-4	PL4
CONVERTER COMPONENTS					
121A	Bushing, Converter Cover	1	72-Up	101032	21000
191A	Strip Lock, Converter Hub 644, 654	6	72-Up	101088B	21212
191A	Strip Lock, Converter Hub Exc 644, 654	4	72-Up	101088A	11212
60A	Friction, Lockup (Can use 181104)	1	72-Up	101115	21106
135A	Sealing Ring, Converter Pump Hub	1	72-Up	101186	21300
183A	Race, Converter Stator 643	1	72-Up	101210A	21226
183A	Race, Converter Hub Bearing 640, 650 (Bearing Style Hub)	1	72-Up	101210	21907
183A	Race, Converter Hub Bearing 640, 650 (Bushing Style Hub)	1	72-Up	101210B	21907A
145A	Spacer, Turbine (.015" Gold) Exc 644, 654	1	72-Up	111212	11403
145A	Spacer, Turbine (.015" Gold) 644, 654	1	72-Up	101212	21403
145A	Spacer, Turbine (.030" Silver) Exc 644, 654	1	72-Up	111212A	11403A
145A	Spacer, Turbine (.030" Silver) 644, 654	1	72-Up	101212A	21403A
145A	Spacer, Turbine (.042" Plain) Exc 644, 654	1	72-Up	111212B	11403B
145A	Spacer, Turbine (.042" Plain) 644, 654	1	72-Up	101212B	21403B
145A	Spacer, Turbine (.060" Black) Exc 644, 654	1	72-Up	111212C	11403C
145A	Spacer, Turbine (.060" Black) 644, 654	1	72-Up	101212C	21403C
145A	Spacer, Turbine (.075" Copper) Exc 644, 654	1	72-Up	111212D	11403D
145A	Spacer, Turbine (.075" Copper) 644, 654	1	72-Up	101212D	21403D
N.I.	Washer, Cover (Coated)	6	72-Up	101249A	21154
N.I.	Washer, Flex Plate	6	72-Up	101249A	21154
169A	Bearing, Converter Stator	1	72-Up	111299A	11404
179A	Bearing, Converter Hub, 640, 650	1	72-Up	101299	21883
N.I.	Seal, Washer-Front Pump Bolt	12	72-Up	101309	13161
18B	Gasket, Front Pump to Case	1	72-Up	101310	13162
15B	Seal, Lathe Cut (Front Pump) (Green Stripe)	1	72-Up	101311	13160
12A	Seal, Lathe Cut (Front Pump Cover) 644, 654 (Green Stripe)	1	72-Up	101311A	13175
12A	Seal, Lathe Cut (Front Pump Cover) Exc 644, 654 (Yellow Stripe)	1	72-Up	101311B	13151
9A	Gasket, Converter Pump Hub 640, 650	1	72-Up	111323	13150W
9A	Gasket, Converter Pump Hub 644, 654	1	72-Up	101323	13174
3A	O-Ring, Lockup Clutch (Inner) Exc 644, 654	1	72-Up	101363A	3366PL
3A	Seal, Lockup Clutch (Inner) 644, 654	1	72-Up	101330A	13176
5A	Seal, Lathe Cut Lockup Clutch (Outer) Exc 644, 654	1	72-Up	101331B	13159
5A	Seal, Lathe Cut Lockup Clutch (Outer) 644, 654	1	72-Up	101331A	13177
7A	Seal, Lathe Cut Lockup Clutch (Backing Plate Yellow Stripe)	1	72-Up	101311B	13151
N.I.	O-Ring, Converter Plug / Cooler Fitting (Brown)	1	72-Up	181397	13180
272A	Converter Cover	1	72-Up	101526	21294
277A	Converter / Pump Assembly (Impeller) 643, 653 Ratio TC350	1	72-Up	101525A	21596
277A	Converter / Pump Assembly (Impeller) 643, 653 Ratio TC360	1	72-Up	101525B	21594
277A	Converter / Pump Assembly (Impeller) 643, 653 Ratio TC370	1	72-Up	101525C	21598
177A	Converter Hub, 1st Design (8 Bolt) 640, 650 Bushing Style	1	72-Up	101607B	21206
177A	Converter Hub, 2nd Design (8 Bolt) 640, 650 Bearing Style (w/ bearing)	1	72-Up	101607A	21204A
177A	Converter Hub, 2nd Design (8 Bolt) 640, 650 Bearing Style (w/o bearing)	1	72-Up	101607	21204
177A	Converter Hub, 3rd Design (8 Bolt) .683" Gear Bushing Style	1	72-Up	101607C	21204C
177A	Converter Hub, 4th Design (12 Bolt) 644, 647, 654 Bearing Style	1	72-Up	101607E	21204E
177A	Converter Hub, 4th Design (12 Bolt) 644, 647, 654 Bushing Style	1	72-Up	101607D	21204D
190B	Locking Key, Converter Cover (Football Key)	1	72-Up	101755-6	21209
287A	Bolt, Torque Converter Hub	1	72-Up	M464GE	96-178

THIMBLE TYPE SCREENS/FILTERS GENERAL MOTORS

TH125/C 87-Up  Part # 84014A ref # 51711 Valve Body	TH125/C 87-Up  Part # 64015 ref # 51712 Valve Body	TH180/C 76-Up  Part # 26014 ref # 26712 Governor
4L30E 90-Up  Part # 24015 ref # 41712 Low Solenoid	4L30E 90-Up  Part # 24018 ref # 41712A TCC Solenoid	TH200/C 79-87  Part # 54016B ref # 34713 Pump
TH200-4R 81-90  Part # 54016B ref # 34713 Pump	TH325-4L 82-85  Part # 54014D ref # 32713 Main Regulator	TH350/C 69-86  Part # 44012 ref # 35711 Case
TH350/C 69-86  Part # 44014 ref # 35712 Governor	TH400 TH440-T4 (64-Up) (84-Up)  Part # 54016B ref # 34713 Governor	4T40E 95-UP  Part # 14016 ref # 86712
TH440-T4 85-UP  Part # 84014A ref # 51711 Governor Shaft	TH440-T4 4T60E 84-Up 91-Up  Part # 84012 (66712 w/Tab) 84012A (66712A no Tab)	TH440-T4 84-90  Part # 84015 ref # 66711 3rd Clutch Exhaust
TH440-T4 84-E85  Part # 84016P ref # 66714A TCC Separator Plate(1st Design)	TH440-T4 L85-90  Part # 84016PA ref # 66714 (2nd Design) TCC Separator Plate	AT540 SERIES Allison  Part # 111014 ref # 11712 Governor Tube

THIMBLE TYPE SCREENS/FILTERS GENERAL MOTORS

MT600 Series	Allison	MT600 Series	Allison	MT600 Series	Allison
	Governor Tube (Early)		Governor Tube (Late S/N 58071)		Center Support
Part # 111014 ref # 11712		Part # 101014 ref # 21712		Part # 101017 ref # 21713	
TH700-R4	82-Up	TH700-R4	82-Up	4T60E	91-Up
	Converter/ Governor		Pump		2-1 Manual Servo
Part # 74014A ref # 61711		Part # 74014 ref # 61712		Part # 84017A ref # 66714E	
4T60E	91-Up	4L60E	93-Up	4L60E	93-Up
	Shift Solenoid		Force Motor		Shift Solenoid
Part # 84016E ref # 66714F		Part # 74016P ref # 61713		Part # 74016A ref # 61713A	
4L80E	91-Up	4L80E	91-Up	4L80E	91-Up
	Shift Solenoid		Force Motor		Case/TCC Solenoid
Part # 34018A ref # 34713A		Part # 34018 ref # 34713B		Part # 34016 ref # 34713C	
TAAT SATURN	91-Up	TAAT SATURN	91-Up	4T80E	93-Up
	Solenoid (Small)		Solenoid (Large)		Solenoid
Part # 10017 ref # 81711		Part # 10015 ref # 81711A		Part # 34018 ref # 34713B	
4T80E	93-Up	TH700-R4 4L60E	82-Up 93-Up	4T80E	93-Up
	Pump		TCC Solenoid		Solenoid
Part # 74014A ref # 61711		Part # 74016B ref # 61711A		Part # 94018A ref # 83712B	

SPEEDOMETER DRIVE AND DRIVEN GEARS FOR GM CARS

NOTE: Numbering System — All Drive Gears are prefixed 7G and Driven Gears are prefixed 8G, and the amount of teeth and style are part of the part number.

Ex. $\left\{ \begin{array}{l} \text{Drive Gear Series} \\ \text{Style} \end{array} \right.$ 7G-10B $\left\{ \begin{array}{l} \text{Amount of Teeth} \end{array} \right.$

DRIVE GEARS

ILLUSTRATION	STYLE	SHAFT	CLIP	ILLUSTRATION	STYLE	SHAFT	CLIP	ILLUSTRATION	STYLE	SHAFT	CLIP
	'A'	1.190	5/16"		'D'	1.180	1/2"		'F'		Spline Type
	'B'	1.180	5/16"				TH200/C				
	'C'	1.190	1/2"		'E'	1.190	1/2"		'G'		Steel
		Recessed					TH200/C				TH400

TEETH	STYLE	PART NO.	REFERENCE	REF NO.	TEETH	STYLE	PART NO.	REFERENCE	REF NO.
7	B	44847	6271537	7G-7B	19	B	44847DZ	8640519	7G-19B
8	B	44847AD	2338033	7G-8B	19	C	44847DY	8640188	7G-19C
8	F	44847AB	6261794	7G-8F	19	D	54847DD	8628891	7G-19D
9	A	44847B	6261782	7G-9A					
9	F	44847BA	6261796	7G-9F					
10	B	44847BC	6261785	7G-10B					
15	B	74847A	8642620	7G-15B					
15	G	34847A	8629547	7G-15G					
17	B	44847CA	8640517	7G-17B					
17	D	54847AC	8628793	7G-17D					
17	G	34847C	8629548	7G-17G					
18	A	44847DW	1242873	7G-18A					
18	B	44847DD	8640518	7G-18B					
18	C	44847D	6260037	7G-18C					
18	G	34847D	8629549	7G-18G					

ILLUSTRATION	STYLE	ILLUSTRATION	STYLE	ILLUSTRATION	STYLE
	'A'		'C'		'E'
Teeth Slant Down Right to Left		.305 - 36T-39T 2-1/4"		Use w/Speed Sensor (Steel Shaft)	
		.325 - 40T-45T			TH700-R4
		TH200, 350, 400, 700-R4			
	'B'		'D'		
Teeth Slant Down Left to Right		2-1/4"			
		TH125, 200-4R, 400-T4			

TEETH	STYLE	PART NO.	REFERENCE #'s	TEETH	STYLE	PART NO.	REFERENCE #'s	TEETH	STYLE	PART NO.	REFERENCE #'s
18	A	54848A	8G-18A / 3987918	29	D	64848F	8G-29D / 403999	39	E	74848F	8G-39E / 25513046
19	A	44848	8G-19A / 3987919	30	D	54848BD	8G-30D / 561035	40	C	34848G	8G-40C / 1362048
20	A	44848A	8G-20A / 3987920	31	D	54848BE	8G-31D / 403417	40	E	74848G	8G-40E / 25513047
21	A	44848B	8G-21A / 3987921	34	C	34848A	8G-34C / 9774413	41	C	34848H	8G-41C / 1362195
21	B	44848C	8G-21B / 361629	35	C	34848B	8G-35C / 9780387	41	E	74848H	8G-41E / 25513048
22	A	44848C	8G-22A / 3987922	35	E	74848B	8G-35E / 25513042	42	C	34848HA	8G-42C / 1362049
23	A	44848D	8G-23A / 3860346	36	C	34848C	8G-36C / 1359270	42	E	74848HA	8G-42E / 25513049
24	A	44848E	8G-24A / 3860347	36	E	74848C	8G-36E / 25513043	43	C	34848J	8G-43C / 1362196
25	A	44848F	8G-25A / 3860348	37	C	34848D	8G-37C / 1359271	43	E	74848J	8G-43E / 25513050
27	D	54848BA	8G-27D / 410731	37	E	74848D	8G-37E / 25513044	44	C	34848K	8G-44C / 978-470
28	D	64848E	8G-28D / 416765	38	C	34848E	8G-38C / 1359272	44	E	74848K	8G-44E / 25513051
				38	E	74848E	8G-38E / 25513045	45	C	34848L	8G-45C / 9775187
				39	C	34848F	8G-39C / 1359273	45	E	74848L	8G-45E / 25513052

HOUSINGS

Part # 54848CK ref # 32227 25524924, 25513247	Part # 44774 ref # 35227 345215	Part # 44774BA ref # 35227A (For 34T-39T Gears) 1247266	34774 ref #34227 (For 36T-39T Gears)	34774A ref 34227A (For 40T-45T Gears)
TH125/C, 200-4R, 325 & 4L, TH440-T4	TH200, 350 Chevrolet	TH200, 350; B.O.P.	TH400	

DRIVEN TO BE THE BEST IN...



TORQUE CONVERTERS

TRANSTAR
TRANSTAR INDUSTRIES, INC.®

TRANSTAR INDUSTRIES, INC. • 7350 YOUNG DRIVE • CLEVELAND, OHIO 44146 • WWW.TRANSTAR1.COM

WHEN IT COMES TO TORQUE CONVERTERS, NO ONE IS MORE COMMITTED TO EXCELLENCE THAN TRANSTAR. WE REMANUFACTURE MORE TORQUE CONVERTERS THAN ANYONE ELSE IN THE INDUSTRY, WITH THE HIGHEST QUALITY MANAGEMENT SYSTEMS, PROPRIETARY PROCESSES AND STATE-OF-THE-ART EQUIPMENT. WITH TRANSTAR'S ENHANCED DELIVERY SYSTEM, YOU CAN DEPEND ON "JUST IN TIME" DELIVERY FOR YOUR TORQUE CONVERTERS AS WELL AS ALL YOUR TRANSMISSION REPAIR NEEDS. DRIVEN TO BE THE BEST FOR YOU.

800.359.3339 | www.transtar1.com



TABLE OF CONTENTS - ORANGE PAGES

MISCELLANEOUS TABLE OF CONTENTS

Allison Governor Application Chart.....	159
Conversion Charts (Metric).....	595
Coolers & Related Items	618
Detent Cables	598
Electronic Modules	601
Filters, Chrysler Thimble & Screens	352
Filters, Ford Thimble & Screens.....	291
Filters, GM 4L60E, 4L65E.....	76
Filters, GM Thimble & Screens.....	168
Filters, Honda	389
Filters, Mitsubishi	443
Filters, Toyota A340, A350.....	529
Filters, Toyota A40 Series	510
Floor Shift Cables	599
Hi-Performance Kits	596
Honda 3 Shaft Quick Ref Guide.....	376
Honda Solenoids (Photos).....	390
Honda Solenoids (Text).....	392
Honda Switches	388
Honda Vehicle Model Chart.....	390
Honda Wire Harness Repair Kits	621
Inline Filters	614
Interchange, Misc Section.....	622
Loctite.....	607
Lubricants, Lubegard.....	605
Lubricants, Miscellaneous	619
Lubricants, Smart Blend	603
Marine Transmission	325
Mercedes Band ID	423
Pressure Risers	601
Save the Planet System	565
Schaffer Shifter & Adapters.....	351
Service Items	608-613
Servo Bore Repair Tool Kits.....	620
SonnaFlow	600
Speedo Gears (GM).....	170
The Transporter.....	600
Toyota A40 Vehicle Model Chart	510
Transfer Case Gaskets	616
TranX 2000 & Adapters.....	350
Vehicle ID by Body Series	5
Wheel Bearings & Repair Kits.....	615
ZF-5HP Transmission Fluid.....	581

ADVERTISERS

AC Delco.....	277
Borg Warner.....	363
Hayden Coolers.....	621
Lubegard.....	604
LuK.....	15
Morse Chain.....	225
Recon Converters.....	172
Rostra.....	201
Smart Blend.....	602
Sonnax.....	624
SPX (Inside Back Cover).....	625
Superior	192
Teckpak Fitzall	339
TransGo®.....	299
Trans Tec (Inside Front Cover).....	0
Transtar Overview.....	23
VBX Valve Bodies	101
ZF	571

CONVERSION CHARTS

ENGINE CONVERSION CHART — C.I.D. TO LITRE

ENGINE C.I.D.	LITRE	CYL.	ENGINE C.I.D.	LITRE	CYL.	ENGINE C.I.D.	LITRE	CYL.	ENGINE C.I.D.	LITRE	CYL.
85.0	1.4L	4	198	3.2L	6	283	4.6L	V8	389	6.4L	V8
97.0	1.6L	4	200	3.3L	V6	289	4.7L	V8	390	6.4L	V8
98	1.6L	4	204	3.3L	V6	292	4.8L	6	391	6.4L	V8
104.7	1.7L	4	207	3.4L	V6	300	4.9L	6	392	6.4L	V8
105	1.7L	4	215	3.5L	6	301	4.9L	V8	394	6.5L	V8
107.6	1.8L	4	221	3.6L	V8	302	5.0L	V8	396	6.5L	V8
109.9	1.8L	4	223	3.7L	6	304	5.0L	V8	400	6.6L	V8
110	1.8L	4	225	3.7L	6	305	5.0L	V8	401	6.6L	V8
112	1.8L	4	229	3.8L	V6	307	5.0L	V8	402	6.6L	V8
121	2.0L	4	230	3.8L	V8	312	5.1L	V8	403	6.6L	V8
121.3	2.0L	4	231	3.8L	V6	318	5.2L	V8	406	6.7L	V8
121.5	2.0L	4	232	3.8L	V6	326	5.3L	V8	409	6.7L	V8
122	2.0L	4	235	3.9L	6	327	5.4L	V8	410	6.7L	V8
135	2.2L	4	239	3.9L	V8	330	5.4L	V8	413	6.8L	V8
140	2.3L	4	240	3.9L	L6	331	5.4L	V8	420	6.9L	V8
144	2.4L	6	241	4.0L	V8	332	5.4L	V8	421	6.9L	V8
150	2.5L	4	242	4.0L	6	340	5.6L	V8	425	7.0L	V8
151	2.5L	4	243	4.0L	L6	341	5.6L	V8	426	7.0L	V8
153	2.5L	4	245	4.0L	V6	348	5.7L	V8	427	7.0L	V8
156	2.6L	4	250	4.1L	V6	350	5.7L	V8	428	7.0L	V8
170	2.8L	6	252	4.1L	V6	351	5.8L	V8	429	7.0L	V8
171	2.8L	V6	255	4.2L	V8	352	5.8L	V8	430	7.0L	V8
173	2.8L	V6	256	4.2L	V8	354	5.8L	V8	432	7.1L	V6
177	2.9L	V6	258	4.2L	6	359	5.9L	V8	440	7.2L	V6/V8
179	2.9L	V6	260	4.3L	V6/V8	360	5.9L	V8	446	7.3L	V8
181	3.0L	V6	262	4.3L	6/V8	361	5.9L	V8	454	7.4L	V8
183	3.0L	V6	265	4.3L	V8	368	6.0L	V8	455	7.5L	V8
189	3.1L	V6	267	4.4L	V8	368	6.0L	V8	460	7.5L	V8
194	3.2L	6	270	4.4L	V6	370	6.1L	V8	472	7.7L	V8
195	3.2L	V8	272	4.5L	V8	379	6.2L	V8	475	7.8L	V8
196	3.2L	V6	280	4.6L	V8	381	6.2L	V8	477	7.8L	V8
						383	6.3L	V8	500	8.2L	V8

NOTE: For any engine not listed above, use the following multipliers for proper conversion:
 C.I.D to Liters - Multiply by .016395 Liters to C.I.D - Multiply by 61.025

MEASUREMENT CONVERSION CHART

Fractions Inch	Decimal Inch	Metric (Millimeter)	Fractions Inch	Decimal Inch	Metric (Millimeter)
1/64	.015625	.39688	33/64	.515625	13.09687
1/32	.03125	.79375	17/32	.53125	13.49375
3/64	.046875	1.19062	35/64	.546875	13.89062
1/16	.0625	1.58750	9/16	.5625	14.28750
5/64	.078125	1.98437	37/64	.578125	14.68437
3/32	.09375	2.38125	19/32	.59375	15.08125
7/64	.109375	2.77812	39/64	.609375	15.47812
1/8	.125	3.17500	5/8	.625	15.87500
9/64	.140625	3.57187	41/64	.640625	16.27187
5/32	.15625	3.96875	21/32	.65625	16.66875
11/64	.171875	4.36562	43/64	.671875	17.06562
3/16	.1875	4.76250	11/16	.6875	17.46250
13/64	.203125	5.15937	45/64	.703125	17.85937
7/32	.21875	5.55625	23/32	.71875	18.25625
15/64	.234375	5.95312	47/64	.734375	18.65312
1/4	.250	6.35000	3/4	.750	19.05000
17/64	.265625	6.74687	49/64	.765625	19.44687
9/32	.28125	7.14375	25/32	.78125	19.84375
19/64	.296875	7.54062	51/64	.796875	20.24062
5/16	.3125	7.93750	13/16	.8125	20.63750
21/64	.328125	8.33437	53/64	.828125	21.03437
11/32	.34375	8.73125	27/32	.84375	21.43125
23/64	.359375	9.12812	55/64	.859375	21.82812
3/8	.375	9.52500	7/8	.875	22.22500
25/64	.390625	9.92187	57/64	.890625	22.62187
13/32	.40625	10.31875	29/32	.90625	23.01875
27/64	.421875	10.71562	59/64	.921875	23.41562
7/16	.4375	11.11250	15/16	.9375	23.81250
29/64	.453125	11.50937	61/64	.953125	24.20937
15/32	.46875	11.90625	31/32	.96875	24.60625
31/64	.484375	12.30312	63/64	.984375	25.00312
1/2	.500	12.70000	1	1.00	25.40000

CONVERSION CHARTS

AUTOMATIC TRANSMISSION HI PERFORMANCE RACING KITS & COMPONENTS

APPLICATION DESCRIPTION	COMPLETE HI PERFORMANCE MASTER KIT	RAYBESTOS HI PERFORMANCE FRICTION PLATES	KOLENE COATED HI PERFORMANCE STEEL PLATES	HI PERFORMANCE LINING BRAKE BANDS
CHRYSLER TF6-904 (998/999)	12008CFHP	R12106HP - Hi/Reverse R12108HP - Rear	12126K - Hi/Rev/Rear	N12022D
CHRYSLER TF8-727	22008CFHP	R22108HP - Hi/Rev/Rear	22126K - Hi/Rev/Rear	N22022C
CHRYSLER A670	32008AFHP	R32106HP - Front R32108AHP - Rear	32126AK - Front 32128K - Rear	N32022AHP
CHRYSLER A604	92008AFHP	R92100BHP - Reverse/UD/OD R92104HP - 2nd R92114HP - Low/Rev	92120K - Reverse/UD/OD 92124K - 2nd 92134K - Low/Rev	_____
FORD C4	26008CFHP	R26108HP - Hi/Rev/Fwd	26126K - Hi/Rev/Fwd	R26022K - Kevlar Lining
FORD C6	36008BFHP	R36106HP - Direct R36108BHP - Forward R36110HP - Reverse	36126K - Forward/Direct 36130K - Reverse	N36022C - Intermediate
FORD AOD 80-Up	76008AFHP For Cast Iron Drums	R76104HP - Intermediate R76106HP - Direct R76108AHP - Forward/Rev.	76124K - Intermediate 76126K - Direct 76128K - Forward/Reverse	R76020K - Overdrive R76024K - Reverse
FORD AOD 90-Up	76008BFHP For Steel Drums	R76104HP - Intermediate R76106HP - Direct R76108AHP - Forward/Rev.	76124K - Intermediate 76126AK - Direct 76128AK - Forward 76128BK - Reverse	N76020G - Overdrive R76024K - Reverse
FORD 4R70W	76008EAHP - (93-95) 76008GFHP - (96-UP)	R76104AHP - Intermediate R76106HP - Direct R76108AHP - Forward/Reverse	76124K - Intermediate 76126AK - Direct 76128AK - Forward 76128BK - Reverse	N76020G - Overdrive R76024K - Reverse
FORD E40D/4R100	36008EFHP - E40D 36008EDHP - 4R100	R36100HP - O.D. (E40D) R36100EAHP - O.D. (4R100) R36112HP - Coast R36104EHP - Intermediate R36106HP - Direct R36108BHP - Forward R36110HP - Rev (E40D) R36110EAHP - Rev (4R100)	36120K - Overdrive 36132K - Coast (E40D) 36132EK - Coast (4R100) 36124K - Inter (E40D) 36145K - Inter (4R100) 36126K - Fwd/Direct 36130X - Reverse	_____

NOTE: All Hi Performance Master Kits contain a Gasket Kit, Sealing Rings, Metal Clad Seals, Special Hi Performance Racing Raybestos Friction Plates, Kolene Coated Steel Plates (where available), Screen Type Filters, & Specially Lined Brake Bands. Also included are Bushings, all needed Washers, all critical Parts such as Sprag Clutches, Roller Clutches, Clutch Diaphragm Springs, and Vacuum Modulators where used.

AUTOMATIC TRANSMISSION HI PERFORMANCE RACING KITS & COMPONENTS

APPLICATION DESCRIPTION	COMPLETE HI PERFORMANCE MASTER KIT	RAYBESTOS HI PERFORMANCE FRICTION PLATES	KOLENE COATED HI PERFORMANCE STEEL PLATES	HI PERFORMANCE LINING BRAKE BANDS
GENERAL MOTORS TH200-4R	54008BFHP	R54100BHP - 4th R54114AHP - Low/Reverse R54106AHP - Forward/Direct R54116BHP - Over Run	54134AK - Low/Reverse 54126AAK - Forward 54126AK - Direct 54120BK - 4th	N54022AK
GENERAL MOTORS TH350/C	44008DFHP	R44106HP - Forward/Direct R44104HP - Intermediate R44114HP - Low & Reverse	44126K - Forward/Direct 44124K - Intermediate 44134K - Low & Reverse	R44022HD
GENERAL MOTORS TH400	34008AFHP	R34106HP - Forward/Direct R34104HP - Intermediate	34128B - Forward - .077 34126D - Forward - .090 34124K - Intermediate	R34022HD - Rigid/Front
GENERAL MOTORS 4L80E	34008EFHP - (91-95)	R34100HP - 4th R34116HP - Overrun R34106HP - Forward/Direct R34104AHP - Intermediate	34128B - Forward 34126D - Direct 34124H - Intermediate	R34022HD - Front
GENERAL MOTORS 4T40E	14008AHP	R14104AHP - 2nd R14110AHP - Reverse R14112AHP - Coast R14106AHP - Direct R14108AHP - Forward	14124AK - 2nd 14130AK - Reverse 14132AK - Coast 14126AK - Direct 14128AK - Forward	N14022AHD
GENERAL MOTORS 4T65E	84008GHP - (97-02)	R84100GHP - 4th R84104GHP - 2nd R84106BHP - 3rd I.D. R84126ABHP - 3rd O.D. R84108AHP - Input	84120GK - 4th 84124GK - 2nd 64128K - Input	
GENERAL MOTORS TH700-R4 4L60E	74008BFHP (TH700-R4) 74008EFHP (4L60E)	R74116HP - Overrun R74110AHP - Reverse Input R74108AHP - Forward R74100CHP - 3/4 R74114HP - Low/Reverse	74136K - Overrun 74130K - Reverse Input 74128AK - Forward 74120AK - 3/4 44134K - Low/Reverse	N74020AK N74020C - Wide
GENERAL MOTORS Aluminum Powerglide	114008FHP	R114106AHP - Hi R44114HP - Reverse	114126C - Hi 114130K - Reverse	R114022HP

NOTE: All Hi Performance Master Kits contain a Gasket Kit, Sealing Rings, Metal Clad Seals, Special Hi Performance Racing Raybestos Friction Plates, Kolene Coated Steel Plates (where available), Screen Type Filters, & Specially Lined Brake Bands. Also included are Bushings, all needed Washers, all critical Parts such as Sprag Clutches, Roller Clutches, Clutch Diaphragm Springs, and Vacuum Modulators where used.

DETENT CABLE REPAIR KITS

SHIFT CONTROL CABLES (FLOOR MOUNT)

TYPE 1
(Plastic Eyelet)

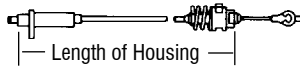

TYPE 2
(Slotted Clevis)



TYPE 3
(Needle)

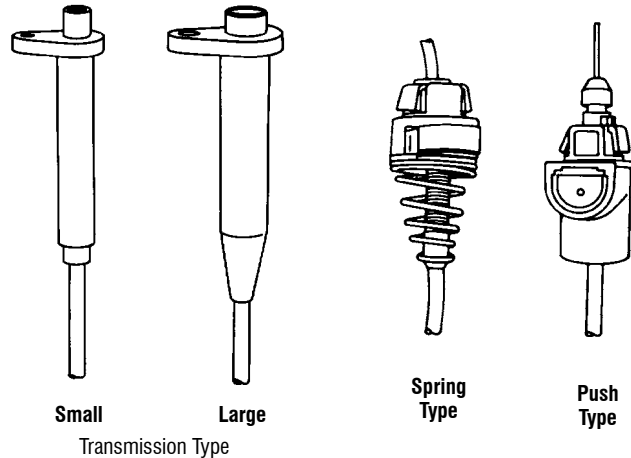
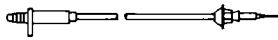

Small Large
Transmission Type

LENGTH OF HOUSING (TO CLOSEST 1/2")	CABLE TYPE (ENGINE END)	SNAP LOCK (PUSH OR SPRING)	TRANS. TYPE (LARGE OR SMALL END)	SEAL (O-RING OR BOOT)	PART NO.
26-1/2"	GM 1	Push	Large	Boot	Use 81-1002
33-1/2"	GM 1	Push	Large	Boot	Use 81-1002
33-1/2"	GM 1	Push	Small	Boot	81-971A
34"	GM 2	Spring	Small	O-Ring	Use 81-1003
34-1/2"	GM 1	Spring	Small	Boot	Use 81-1003
35"	GM 1	Push	Large	Boot	Use 81-1002
36-1/2"	GM 2	Spring	Small	O-Ring	81-951
40"	GM 1	Push	Small	Boot	Use 81-1003
42"	GM 1	Push	Large	Boot	Use 81-1004
45"	GM 1	Push	Large	Boot	Use 81-1004
51-1/2"	GM 1	Push	Large	Boot	81-881
18"	Ford 1	Spring	Large	Boot	81-982
46"	Ford 1	Spring	Large	Boot	81-983
48-1/4"	ZF4HP14/18	—	—	—	81-2000
52"	ZF4HP14/18	—	—	—	81-2003
36-1/2"	ZF4HP22/24	—	—	—	81-2005

NOTE: Small End (transmission) fits TH250/C, TH350/C. Large End (transmission) fits TH125/C, 200C, 200-4R, 325, 325-4L, 440T4, 700-R4.
81-982 fits: 86 Taurus & Sable w/3.0 & 3.8L; 87 Taurus & Sable w/3.0L; 90-91 Taurus & Sable w/3.0L.
81-983 fits: 88-89 Taurus & Sable w/3.0L; 88-91 Taurus, Sable & Lincoln w/3.8L.

UNIVERSAL STYLE CABLES — GM







28" - 45"	GM 1 & 2	—	Small	Boot	81-1000
28" - 48"	GM 1 & 2	—	Large	Boot	81-1001

NOTE: 81-1000 & 81-1001 are with telescope type housing and include Type 1 End (Plastic Eyelet) and Type 2 End (Slotted Clevis).

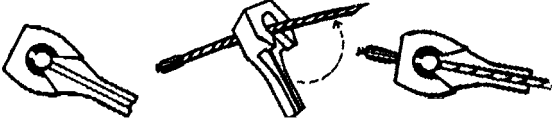
34"	GM 1	Spring	Large	Boot	81-1002
38-1/2"	GM 1	Spring	Small	Boot	81-1003
46"	GM 1	Spring	Large	Boot	81-1004

NOTE: 81-1002, 81-1003, 81-1004 are with fixed housing (Cable end is adjustable). Includes Type 1 End (Plastic Eyelet). For Type 2 End (Slotted Clevis) order Part No. 81-909D separately.

DETENT CABLE ASSEMBLIES GM & FORD

<p>Part No. T44451DC</p> <p>T.V. Detent Cable Repair Kit w/Small O.D. (.500) Cable TH350/C Repair TH200/C Conversion & Repair</p> 	<p>Part No. 44451B Plastic Replacement Clip</p>  <p>Insert crimped end & rotate 90°</p> <p>Snap cable end into place</p>
<p>Part No. 74451</p> <p>T.V. Cable Conversion Kit Converts Most 700-R4 & Large O.D. Cable (.700) TH200 T.V. Cables to a TH350 Cable. Instructions Included</p> 	<p>Part No. S74451G</p> <p>TV Cable Extender for use w/Edlebrock Carburetors (GM Applications w/TV Cable).</p> 
<p>Part No. T74451C</p> <p>T.V. Cable Repair Kit w/Large O.D. (.700) Cable 200 Thru 700-R4</p> 	<p>Part No. S74451E</p> <p>T.V. Cable Kit - Spring/ Return -Carb End</p> 
<p>Part No. S74451H</p> <p>Throttle Cable Extender for use w/Holley Carburetors</p> 	<p>Part No. T57451</p> <p>Cable Repair Kit For Asian Warner, Borg Warner, Toyota, Volvo, Jag, ZF</p>  <p>Instructions Included</p>

UNIVERSAL TRANSMISSION SHIFT CONTROL CABLES (for Cars with Floor Mounted Shift)

DESCRIPTION	QTY.	YEAR	PART NO.	REFERENCE NO.
TH200, 200C, 350, 350C, 375B				
All Buick, Chevrolet, Oldsmobile & Pontiac Models (Exc. below, Exc. Hurst Dual Gate-Cutlass)	1	78-80	44452C	22500584
78-80 Skyhawk, 76-80 Monza, Vega, Starfire, Astre & Sunbird.....	1	76-80	44452B	470771
75-80 Camaro, 78-80 Firebird, 75-77 Grand Prix, 75-77 LeMans, 76-79 Phoenix, 76-79 Ventura.....	1	75-80	44452A	9791611

DETENT CABLES

SPECIALTY TOOL NUMERICAL LISTINGS & ILLUSTRATIONS



The TransPorter

*No other tool does
so much, so fast,
AND with NO MESS!*

Reduce Labor Costs & Increase Profits

In seconds, with this simple-to-use tool, drain and fill any viscosity fluid - even heavy gear grease. Patented design fits into hard to reach openings and eliminates messy drips and spills. Requires pressurized air and/or vacuum source.

T-0012-TP

TransPorter Fluid Evacuator/Injector

T-0012-TPHCA

TransPorter Hydraulic Adapter

SonnaFlow™ Flow Meter Diagnostic Tool

A diagnostic tool for measuring ATF flow rates

Stop Comebacks!

**Never deliver a vehicle with
low cooler/lube flow again!**

Compact unit, quick installation, no bulky hoses or fluid containers.

Measures flow of automatic transmission fluid in gallons-per-minute digital readout.

Accurate diagnosis by replacing unreliable 1-quart-in-20-seconds method.

Detects blocked cooler flow and verifies lockup.

Lab-scope graphing ability detects problems with clutch/pump volume, aerated fluid, filter blockage, hydraulic/electronic failsafe, and hanging valves.

Allows you to visually observe flow changes during road tests.



Kit contains meter with large display numbers and low-flow warning light, all the necessary brass fittings, detachable power cord, 2-foot insulated signal cable, durable electrical connectors, and a manual with complete instructions and troubleshooting guide.

T-FM-01K

Flow Meter Kit

T-FM-01K-1

Output Signal Adapter

Also Available by Special Order:

5/16" and 3/8" splice kits and replacement parts that include: sensor assembly, signal cable, display box, power cord, and hanging bracket assembly.

ELECTRONIC MODULES

Electronic Modules or Components listed do a variety of functions: (ie.- boost pressure,delay/modify lock-up/shifts, etc...). A module may connect directly to the transmission or computer. Modules may also be listed in transmission electrical sections.

ELECTRONIC MODULES				
Various	Provide adjustable delay (35-55 mph) for lockup.	-		LU1
Gm FWD	Provide VSS signal for 30A-100 when computer doesn't have VSS.	-		LU1-4226
Ford Bronco/Ranger	Provide VSS signal for 30A-100 when computer doesn't have VSS.	-		LU1-4227
Chrysler RWD	Provide VSS signal for 30A-100 when computer doesn't have VSS.	-		LU1-4228
Chrysler FWD	Provide VSS signal for 30A-100 when computer doesn't have VSS.	-		LU1-4229
Ford T-Bird/Mustang	Provide VSS signal for 30A-100 when computer doesn't have VSS.	-		LU1-4230
GM w/o extension cable	Provide VSS signal for 30A-100 when computer doesn't have VSS.	-		LU1-4231
Ford w/E40D	Enable 30A-100 to be used on some E40D models.	-		LU1-4233
Ford E40D	Interceptor - Provides adjustable line pressure rise & modifies lockup signal.	89-94		36447E
Ford E40D	Interceptor - Provides adjustable line pressure rise & modifies lockup signal.	95-Up		36447IA
GM 4L60E	Interceptor - Provides adjustable line pressure rise & modifies lockup signal.	93-Up		74447E
GM 4L80E	Interceptor - Provides adjustable line pressure rise & modifies lockup signal.	94-Up		34447E
GM 4T40E	Interceptor - Provides adjustable line pressure rise & modifies lockup signal.	95-Up		14447C
GM 4T65E	Interceptor - Provides adjustable line pressure rise & modifies lockup signal.	97-Up		84447GC
Ford E40D	Applies coast clutch in 1 st , 2 nd , and 3 rd , w/o using overdrive cancel button.	89-94		36447C
Ford E40D	Applies coast clutch in 1 st , 2 nd , and 3 rd , w/o using overdrive cancel button.	95-98		36447CA
Ford AODE	Modifies TCC Signal to eliminate converter shudder.	-		76416A
GM/Chrysler	Speedometer Recalibration	-		A34447
Ford Various	Delays 4 th gear w/o using overdrive cancel button and is adjustable.	-		36447B
GM Various	Ignition Bypass Relay	-		GM-RELAY
GM Various	Provide improved computer ground (1 wire)	-		74448AK
GM Various	Provide improved computer ground (3 wire) Rostra	-		74448K
PRESSURE RISER - ADJUSTABLE				
Ford E40D	Provides adjustable line pressure rise (3 levels).	89-93		PR231
Ford E40D	Provides adjustable line pressure rise (3 levels).	94-00		PR235
GM 4L60E/4L80E	Provides adjustable line pressure rise (3 levels).	-		PR230
Ford AXODE	Provides adjustable line pressure rise (3 levels).	-		PR233
Ford AODE	Provides adjustable line pressure rise (3 levels).	-		PR232
Mits/Nissan - KM/RE4	Provides adjustable line pressure rise (3 levels).	-		PR234
PRESSURE RISER - FIXED				
TRANSMISSIONS	DESCRIPTION	STANDARD PART#	HEAVY DUTY PART#	HEAVY DUTY PLUS PART#
Ford E40D (89-E93)	Provides fixed line pressure rise.	PR204	PR205	PR206
Ford E40D (L93-98)	Provides fixed line pressure rise.	PR209	PR210	PR211
GM 4L60E/4L80E	Provides fixed line pressure rise.	PR201	PR202	PR204
Ford AXODE/AX4N	Provides fixed line pressure rise.	PR204	PR206	PR207
Ford AODE/4R70W	Provides fixed line pressure rise.	PR204	PR207	PR208
Mits/Nissan - KM/RE4	Provides fixed line pressure rise.	PR201	PR202	PR204

EM/TPS

SMART BLEND

SYNTHETICS

LIFE AUTOMOTIVE PRODUCTS INC.
Multiple OEM Approved Supplier



M465F18
96-306
Transmission Cooler Flush



M465JB
96-312
Valve Body/Governor Protectant



M465J
96-314
2-in-1 Electronic Cleaner/Protectant



M465TP
96-304
Transmission Assembly Lube



M465AA
96-304A
SYNTHETIC Transmission Assembly Lubricant



M465SBE
96-332
SYNTHETIC Instant Shudder Eliminator



M465SBV
96-313B
SYNTHETIC ATF M-V Supplement



M465SBD6
96-313E
SYNTHETIC D-VI ATF Supplement



M465SBA
96-313A
SYNTHETIC HFM ATF Supplement



M465SBG
96-333
SYNTHETIC Gear Fluid Supplement



M465SB
96-313
SYNTHETIC ATF Protectant



M465SBT
96-313C
SYNTHETIC Multi-Vehicle ATF Protectant







M468
96-307
LIFE STRIPS TRANSMISSION TEMPERATURE RECORDERS





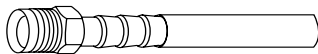

TRUSTED & PROVEN Transmission Products!

Call toll free 1-800-359-3339 for a location near you.

www.transtar1.com

Visit www.smartblend.com to See Our Full-Line of Professional Transmission Products

LIFE	
	<p>Transmission Prep Assembly (16 oz. Tub)</p> <p>Lube - M465TP</p> <p>Synthetic Lube - M465AA</p>
	<p>Trans Flush</p> <p>(18 oz. Can) - M465F18 (14 oz. Can) - M465F14</p> <p>To Flush Transmission Coolers & Lines</p>
	<p>M465FB M465FK (Kit)</p> <p>3/8" Fitting w/Hose (For M465F18)</p>
	<p>M468</p> <p>Life Strips (Packaged in 10's) Transmission Temperature Recorders</p>
	<p>M465SBF</p> <p>Synthetic Trans Flush (White Bottle - 10 oz) Cleans & Prepares transmission for new ATF</p>
	<p>M465JB</p> <p>Trans Prep III (Spray Cans Sold Individually ONLY)</p>

LIFE	
	<p>Smart Blend</p> <p>M465SB Synthetic ATF Protectant (Red bottle - 10 oz)</p> <hr/> <p>M465SBA Synthetic HFM Supplement (Black Bottle - 10 oz)</p> <hr/> <p>M465SBV M-V Supplement (Blue Bottle - 10 oz)</p> <hr/> <p>M465SBT Titanium Supplement (Silver Bottle - 10 oz)</p> <hr/> <p>M465SBS (Suv Formula 16 OZ)</p> <hr/> <p>M465SBD6 Synthetic Dexron VI Supplement (10 oz)</p>
	<p>M465SBFK</p> <p>Smart Blend Flush Package Red/White (2-10 oz. Bottles)</p>
	<p>M465J</p> <p>Tru-Volt Electronic Cleaner (10 oz. Can)</p>
	<p>M473S</p> <p>Sure Grip Clear (12 oz. Can)</p>
	<p>M465SBE</p> <p>Shudder Eliminator (2 oz. Tube)</p>
	<p>M465SBG</p> <p>Gear Fluid Supplement (10 oz. Bottle)</p>

STILL HAVING TROUBLE WITH THESE?



SEAL-E-ZEE™ is a MUST for the following difficult applications;

Thanks to Seal-E-Zee, trouble seating difficult applications are now a thing of the past!

The professional technicians speedy way to safely fit any seal with confidence!

SEAL-E-ZEE with the application cones fit virtually any size seal-application to help technicians overcome difficulties fitting molded pistons and lip-seals.

Chrysler	A604	Low/reverse piston	GM	4L80E	Direct clutch piston
Chrysler	A500/A518	OD brake piston	GM	5L40E	All molded pistons
Chrysler	TF8	3rd/reverse lip seals	Nissan	RE4R01A	Low/reverse piston
Ford	A4LD	Center support rings	Nissan	JR403E	Center support umbrella seals
Ford	CD4E	All molded pistons	Nissan	JF506E	Low clutch lip seal/balance piston
Ford	AX4S	Reverse drum piston/outer seal	Saturn	TAAT	Piston seals
Ford	4R70W	Reverse input drum piston seals	VW	Various	All molded pistons
Ford	5R55N	Forward/intermediate pistons	Various	KM Series	OD clutch lip seal
Ford	5R55W	Forward clutch piston seals	Various	CVT	Reverse piston
GM	4L30E	3rd clutch piston	Various	Various	VB bore plug O-rings
GM	4L30E	Solid Teflon® rings	Euro	AL4 / DPO	E2 balance piston

SEAL-E-ZEE STARTER SET

Starter Set Includes;

- (1) Set of Seal-E-Zee cones, in 6 sizes
- (1) Box containing Seal-E-Zee Original & Seal-E-Zee XTREME in 5 oz. bottles
- (1) CDROM with product demonstrations
- (1) Set of instructions
- (1) Product sheet with application information



T-M465LS

How it works with the GM5L40E Piston...

See more product demos at www.Lubegard.com



Select the cones that fit the 2 piston seals.



Firmly press the piston into the cone.



Spray with Seal-E-Zee Original. Follow with Seal-E-Zee Xtreme.



Repeat the process with the inner seal.



Install with EASE!

www.Lubegard.com



LUBEGARD	
	<p>Assemblee Goo (16 oz. Tub)</p> <p>M465TG - (Green) M465TB - (Blue)</p>
	<p>M465KD Kooler Kleen (13 oz. Can)</p>
	<p>M465LF Free-eze (15 oz. Bottle)</p>
	<p>M465HA Dr. Tranny Instant Shudder Fixx (10 oz. Tube)</p>
	<p>M465LA All Purpose Lube (4 oz. Each - Sold Individually Only)</p>
	<p>M465EA Bio-Tech Engine Protectant (15 oz. Bottle)</p>
	<p>M465EF Bio-Tech Engine Flush (15 oz. Bottle)</p>
	<p>M465EAP Bio-Tech - Twin Pack (2 - 15 oz. Bottles)</p>
	<p>M465D Limited Slip Fluid Supplement (4 oz. Bottle)</p> <p>For Use With All Limited Slip Differentials</p>

LUBEGARD	
	<p>Lubegard Power Steering</p> <p>M465P - Fluid (10 oz. Bottle) M465PS - Supplement (4 oz. Bottle) M465PSP - Twin Pack (2 - Bottles)</p>
	<p>M465G Lubegard Gear Fluid Supplement w/LXE (8 oz. Bottle)</p>
	<p>Transmission Fluid Supplements</p> <p>ATF Protectant M465L (10 oz. Red Bottle) All Exc. Chrysler, Honda, Toyota</p> <p>M465LG-5 (5 Gallon Pail) All Exc. Chrysler, Honda, Toyota</p>
	<p>HFM-ATF Protectant M465B (10 oz. Black Bottle) Chrysler, Honda, Toyota</p>
	<p>M-V M465LMV (10 oz. Black & Green Bottle) Mercon V for Ford</p>
	<p>Lubegard Platinum M465LP (10 oz. Bottle) Universal ATF Protectant</p>
	<p>Automatic Transmission Flush M465LTF (10 oz. Bottle)</p>
	<p>Flush & Protect Performance Packs (2 - 10oz. Bottles)</p> <p>M465LPK ATF Protectant M465BP HFM-ATF Protectant M465LMVP MERCON-V M465LPP Platinum</p>

SPECIAL SERVICE ITEMS

LUBEGARD



M465VS (16 oz. Bottle)
M465VSG (1 Gallon)

Lubegard Valve & Assembly Lube



M465LSR
Lubegard Brake Squeak Relief
 (11 oz. Bottle)

M465LSRG
Squeak Relief Uni Brake Grease

KOOL-IT



M465KT (16 oz. Bottle)
Supreme Coolant Treatment

M465KRF (16 oz. Bottle)
Cooler Flush

M465KTP (2 - 16 oz. Bottles)
Flush & Protect Performance Pack

M465KE
Evap/Heat Form Cleaner



M465TAT
Lubegard Assembly Treatment
 (8 oz. Bottle)

M465FS
3 Step Air & Fuel System Tune Up

M465LS use w/ T-9405
SEAL-E-ZEE Piston Installer Regular

M465LSX use w/ T-9405
SEAL-E-ZEE Piston Installer Extra Strength

MUSCLE



M465MT8
MT-10 Muscle Metal Treatment - 8 oz.
 (Sold Individually)



M465MLS
STAR LUBE™ Transmission Assembly Spray Lube
 (16 fl. oz. In A Trigger Sprayer)

Cleans, Conditions, Lubricates and Protects.

SPX



M465TJG
 (1 lb. Tubs)
Gold Transmission Assembly Lube
 (Sealed Power Brand)

SONNAX



M465SLS
Slippery Stick
 Sonnax Lube Stick

TRANSTAR



M469B
Silicone RTV Sealant
 3.0 fl. oz. Tube
 (Sold 12 per case ONLY)



M469BLA
Silicone RTV Sealant
 10.1 fl. oz. Cartridge
 (Sold individually ONLY)



M465C
Carb & Choke Cleaner
 (12 oz. Can)
 Sold Individually and 12/Case)



M465BKSC
 (California Compliant)
M465BKN
 (Not for sale in California)
Non-Chlorinated Brake Cleaner & Degreaser
 (12 oz. Can - Sold Individually and 12/Case)

LOCTITE



For over fifty years, Loctite products have been reliably solving automotive maintenance and repair needs. When you buy Loctite products you're getting the same product that vehicle manufacturers use in production. Why use anything else?

SEALANTS

M469BB	High Performance RTV Black	(In Pressurized Can)	9 oz. can
M469R	High Temperature RTV Red		80 ml. tube
M469-518	Case to Case Gasket Maker 518	(Use w/o Gasket)	50 ml. tube
M469LGS	High-Tac Gasket Coating	(Use w/Gasket)	16 oz. can

THREAD/BEARING LOCKER

M478-609	Bearing Mount (Locker) 609	(Retains bushings/sleeves/etc.)	36 ml. bottle
M478-242	Threadlocker Blue 242 Medium Strength		36 ml. bottle
M478-242S	Threadlocker Blue 242 Medium Strength	(Lipstick Applicator)	19 g. stick
M478-271A	Threadlocker Red 271 High Strength		36 ml. bottle
M478-271S	Threadlocker Red 271 High Strength	(Lipstick Applicator)	19 g. stick

THREAD DRESSING

M478	Thread Sealant 565 White		50 ml. tube
M478-S	Thread Sealant 565 White	(Lipstick Applicator)	19 g. stick
M478-T	Form-A-Thread	(For Thread Repair)	4.8 ml. syringe









ANTI-SEIZE



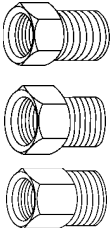
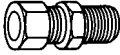



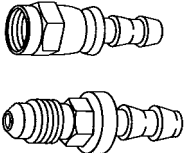

M478-CPR	Anti-Seize/Lubricant Copper	(Loosen/Prevents Rusted Threads)	1 lb. can
M478-CPRS	Anti-Seize/Lubricant Copper	(Lipstick applicator)	20 g. stick

ADHESIVE

M478-G	Quick Gel Adhesive (thick, not runny)	(Bonds various materials)	2 g. tube
---------------	---------------------------------------	---------------------------	-----------

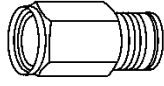
SPECIAL SERVICE ITEMS

COOLER LINE COMPONENTS	
	Compression Fittings M462F (5/16") M462FA (3/8") M462FB (1/2 Line)
	Inverted Flare Nut M462JB (5/16" Line) M462JC (3/8" Line)
	Flared Line Case Fittings M462C (5/16" Line x 1/4" Pipe) M462GB (5/16" Line x 1/8" Pipe) M462DC (3/8" Line x 1/4" Pipe) M462DD (3/8" Line x 3/8" Pipe)
	Compression Fitting M462FF (5/16" Line x 1/4" Pipe)
Steel Lines w/Flare Fitting 	M461AB (5/16" x 30") M461A (5/16" x 60") M461AA (5/16" x 72") M461BC (3/8" x 30") M461B (3/8" x 60") M461BA (3/8" x 72")
	Copper Tubing M461AC-25 (5/16" - 25 FT) M461BC-25 (3/8" - 25 FT) M461AC-50 (5/16" - 50 FT)
Compression Fitting w/Anti Drainback 	A36761C (5/16") A36761D (3/8") To Eliminate Torque Converter Drainback Thru Cooler Lines. Use On Any 5/16" (96-200C) or 3/8" (96-200D) Cooler Lines.
Transmission Cooler Line Fitting Kit 	OC-K252 Contains: 1/4" Male Pipe x 3/8" Hose Barb 1/4" Female Pipe x 3/8" Hose Barb 3/8" Male Pipe x 3/8" Hose Barb 12" Teflon Pipe Thread Ford - Mercury - Lincoln Instructions Included
Transmission Cooler Line Fitting Kit 	OC-390 Contains: 5/8" -18 Inverted Male Fitting 5/8" -18 Inverted Female Fitting 91-Up GM FWD, 87 & Earlier Jeeps w/5/8" Inverted Male Flare Fittings Instructions Included

COOLER LINE COMPONENTS (Cont.)	
Transmission Cooler Line Fitting Kit 	OC-391 Contains: 5/8" -18 SAE Male Fitting 5/8" -18 SAE Female Fitting 88-Up Jeeps w/ 5/8"-45° Female Flare SAE Fitting Instructions Included
Transmission Cooler Line Fitting Kit 	OC-392 Contains: (2) 3/8" Hose Menders (2) 3/8" Hose Clamps 87-Up Jeeps Using Rubber Hose, w/Quick Disconnect At Radiator. Instructions Included
	Compression Fittings w/ Hose Barb M462FE (3/8" Line) M462FD (5/16" Line)
Cooler Flushing Fitting 	M465FA Quick, easy hook-up. Can be used with large flusher or aerosol cans with adapter. Fits most sizes of cooler line Banjo fittings.
ALLISON	
121996 LT1000 00-Up Fitting Case (Push-in)	
GENERAL MOTORS	
	Case Fitting w/Ball 84996 4T60 83-Up(24207294) 84996AA 4T60E 91-98 (24202550) 74996A 4T60E/65E (push-in) 8-Up (24213958)
Push-In Case Fitting w/o Ball 	74996B (5/16" Line x 1/4" Pipe) 4L60E, 93-Up 4L80E, 97-Up (front) 4T60E/65E, 98-Up
Rear Case Fitting 	34996EA Push In (5/16" Line x 1/4" Pipe) 4L80E, 97-Up 34996K Adapter Cooler Line Late Case to Early Model
	FORD 90° Elbow M462GC (5/16" Line, 1/8" Pipe)

SPECIAL SERVICE ITEMS

COOLER LINE COMPONENTS (Cont.)

FORD (Cont.)

Cooler Line Fittings



T76996
Push In (5/16" Line x 1/4" Pipe)



T86996
Push In (5/16" Line x 1/4" Pipe)
Clip Design
F5DZ-7D273AA



T56996
Push In (5/16" Line x 3/8" Pipe)
F7ZZ-7D273A

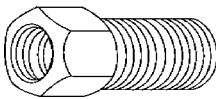

**Flared Line Case Fitting
w/Anti Drain Back Ball**
36996A (5/16" Line x 3/8" Pipe)

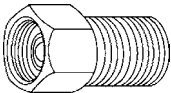

36999C (3/8" Line x 3/8" Pipe)

To Eliminate Torque Converter Drainback
Thru Cooler Lines. Use On Any 5/16"
(96-396) or 3/8" (96-396A) Cooler Lines.

Case Fitting

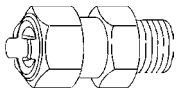

86996H Push In (3/8" Line x 1/4"
Pipe)
Clip Design

CHRYSLER

Male Connector



M462AB (5/16" Line x 1/8" Pipe)
M462AC (3/8" Line X 1/4" Pipe)



Flared Line Nut
M462NB (5/16" x 5/16")
M462NC (3/8" X 3/8")



Case Cooler Fittings

T22996A Push In
(3/8" Line x 1/4" Pipe)



T22996B Push In
(1/2" Line x 1/4" Pipe)



22996C Flared
(1/2" Line x 1/4" Pipe)

MISCELLANEOUS



M462PA
Converter Plug (1/8")
Allen Head



M463TA (1/4")
M463TB (3/16")
Plastic Vacuum Tees



M463EB (1/4" Shaft)
M463EA (3/16" Shaft)
E Clips



M463GB
GM Linkage Grommet (White)



M463GA
Chrysler Linkage Grommet



M463GE
Upper & Lower Rod Grommet
TF6 & TF8



M463GF
Grommet - All Large
Ford C4 & C6



M463GG
Plastic Bushing
All Small Ford



M463CL (1-13/16" - GM)
M463CK (1-1/16" Chrysler)
M463CJ (3/4" - Chrysler)
Hitch Pins



M462PB (1/8" Hex Brass)
M462P (1/8" Hex)
M462PC (7/16" Hex C-4, C-5)
Converter Plugs



M460HC (5/16" x 1/2")
M460HCA (7/32" x 7/8")
ID Range
Clamps



M462JD (3/16" x 1/8")
Modulator Hose Barb

ORMK

O'Ring Kit Masker Kit

Valve Body Components

SSPP

Small Parts Start Up Kit

Valve Body Components

SPECIAL SERVICE ITEMS

MISCELLANEOUS (Cont.)



M460BA (5/16" ID - 25')
M460DA (3/8" ID - 25')
M460C (11/32" ID - 5')
M460CA (11/32" ID - 25")
M460CB (11/32" ID - 50")
M460EA (1/2" ID - 25')

Hydraulic Line Hose

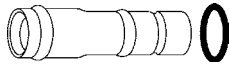

44494D
Quick Fix Filler Tube



T44494R
**Dip Stick Repair Tube -
 Boot Type**

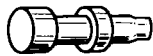

44490
Case Vent Tube
 TH350



D34490
Case Vent Tube
 TH400, TH700-R4



26164K
Select A Pin Package
 (Contains 10 Pins And 1 Gauge)



M474GC (3/8" - 24T - Fine - Self Locking - C4)
M474FA (3/8" - 24T - Fine - w/Flange - C4)
M474GB (3/8" - 16T - Coarse - Self Locking - GM)
M474FB (10mm x 1mm - Metric)

Converter Nuts

M464CB (5/16" x 7/16" - 24T - Fine - TF6 & TF8 TC Converter)

M464GF (3/8" x 9/16" - 24T - Fine - Standard Bolt)

M464GD (3/8" x 1/2" - 16T - Coarse - GM Converter)

M464GL Bolt - Pan Metric 700R4(Bag100)

M464MA Bolt - Converter 10mm x 1.5 Mitsubishi

M464MB Bolt - Converter 10mm x 1.25 Mitsubishi

M464GE (10 x 14.295 - 1.5T - Coarse - Metric - GM Converter)

M464GK (01-Up - Double Hex - GM Converter - 11589040)

M464GM (96-Up - Torx - GM Bellhousing to Case - 24203265)

M464CA (A604 Chrysler Converter Bolt - 4 Required)



M471Y (Yellow Bottle Marker)
M471YS (Yellow Stick Marker)
M471W (White Bottle Marker)
M471YWS (White Stick Marker)

(Sold Individually)

MISCELLANEOUS (Cont.)



Case of 12
M473MG-12
M473BF-12
M473CA-12
M473G-12
M473B-12
M473CB-12

Color
 Machine Gray
 Chevy Blue
 Aluminum
 Gold
 Black
 Cast Black

Transmission & Engine Enamel



5000 Hour
 Brass Base
 130 Volt

M472-50 (50 Watt - Frost - Reg. Rough Service)
M472-50C (50 Watt - Tuffskin Coated - Shatterproof)
M472-75 (75 Watt - Frost - Regular Rough Service)
M472-100 (100 Watt - Frost - Reg. Rough Service)
M472-75S (75 Watt - Tuffskin Coated - Shatterproof)
M472-100C (100 Watt - Tuffskin Coated - Shatterproof)

Rough Service Bulbs - Special Filament
 (Regular - Sold 12 Per Case ONLY)
 (Tuffskin Coated - Sold 6 Per Case ONLY)

AMERICAN MADE

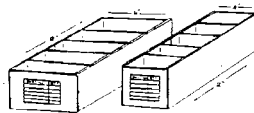

BOX-601 (4" x 4" x 12")
BOX-602 (4" x 6" x 12")

Bin Boxes
 (4 Dividers Included)

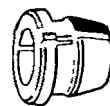

M463GN (Narrow Groove)
M463GP (Wide Groove)

**TV & Passing Gear Rod
 Grommet FIOD & ATX**



M463GM
Shift Linkage Bushing
 TH325/325-4L

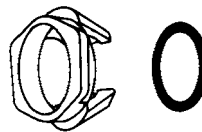

76496K
**Ford Cooler Line
 O-Ring & Clip Kit**
 (Kit Also Contained In T76496AK)
 (Sold 10 Per Package)
 Contains Line Retaining Clip & O-Ring



M470CA(5/8")
M470CB(7/8")
M470CC(1-1/8")
M470CD(1-3/8")

Valve Body Cleaning Brushes
 (Sold Separately and as a Kit,
 Part No. **M470C**)



A44839 (Square Magnet)
A44839B (Round Magnet)
 (Sold Individually and as a kit of
 5 Square pieces, **A44839K**)

MISCELLANEOUS (Cont.)

Thread Insert Repair Kits

Kit Part #	Size	Insert Part #	Std. Pkg.*
COARSE THREAD			
M99125K	1/4" x 20	M99125I	25
M99126K	5/16" x 18	M99126I	25
M99127K	3/8" x 16	M99127I	25
M99128K	7/16" x 14	M99128I	25
METRIC			
M99135K	6mm x 1.00mm Pitch	M99135I	25
M99136K	8mm x 1.25mm Pitch	M99136I	25
M99137K	10mm x 1.50mm Pitch	M99137I	25

Kits Are Packaged In A Top Quality Steel Tool Box And Contain:

- A High Quality, Easy-To-Use Hand Tap
- An Insertion Tool
- 10 Inserts*
- Complete Instructions

(* All Inserts Are Available In Minimum Packages Of 25 Each.)



1) Drill To Clear Out The Damaged Thread

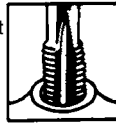

2) Thread Insert Tap

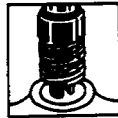

3) Install Insert



4) Remove Insertion Tang



M463GK Black
M463GL Green
GM Grommet - Oval

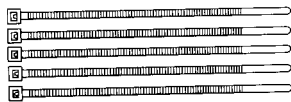

M463N
Plastic Cable Ties
(Minimum Package of 25)



CRA-Z
CRA-Z Soap
(1 Carton of 12, 10.7 oz. Bars)

CRA-ZD
CRA-Z Soap Dispenser

MISCELLANEOUS (Cont.)



MBK-249
Mitsubishi Filter Bolts
(4 Per Package)
Use w/ 42010E- 87-Up - KM171 Series

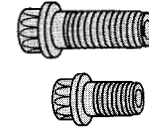

A34783A (GM 4L80E)
D34783 (GM TH400)
Center Support Bolts
(Sold 1 Per Package)

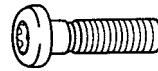

D34784 (GM 4L80E)
4th Housing Bolt
(Sold 1 Per Package)

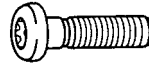

A74778
Stator Cover Bolt
700-R4

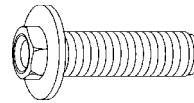

A36783
Center Support Bolt - Long
E4OD

A36783A
Intermediate & Overdrive
Housing Bolt - Short
E4OD

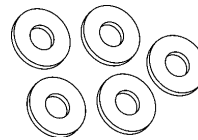

TC-36605-01
Shift Shaft Spacers
WG1356
(Available in Packages of 5 Only)

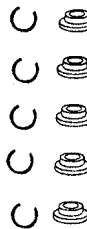

VB-101
Valve Body Plate Ball Seat
Repair Package

1/4" Ball Package Includes 5 Seats & Clips. Fits And Repairs 75% Of All Valve Bodies.
GM - Ford - Chrysler - Imports
Instructions Included

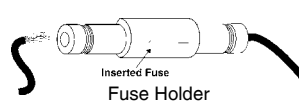

M463PF
Posi-Lock Fuse Holder
(For 12 to 18 Gauge)

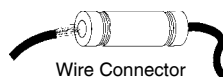











M463PA
Posi-Lock Wire Connector

M463PK
Posi-Lock Survivor Kit
(Posi-Lock Assortment Box)



SPECIAL SERVICE ITEMS

MISCELLANEOUS (Cont.)	
	<p>M464CA Torque Converter Bolts A604 Chrysler - 90-Up</p>
	<p>M463SA(Approx. 15" Long) M463SB(Approx. 42" Long) Ground Straps</p>
	<p>T-3020 Drain Plug Kit</p>
	<p>D46494 D46494B Drain Plug Drain Plug 5R55N 5R55W 00-Up 02-Up</p>
	<p>M463GQ TV Passing Gear Rod Grommet/Clip Package (4 Pieces Each Grommet & Clip) AOD/ATX</p>
	<p>M464K-120 Converter Nut & Bolt Assortment 120 Pieces - 6 Different Numbers (Also Available Separately)</p>
	<p>TT-MH Pan Handler (Magnetic Tool) Saves Time, Eliminates Use Of Rags Or Gloves, Collects Pan Metal Shavings. Many Other Uses. No More Burnt Fingers or Hands!</p>
	<p>T76496AK Ford Cooler Line O-Ring Installation Tool Kit (Includes 2 O-Rings & Retaining Clips [96-213K]) Complete Instructions Included</p>
	<p>M7005M (Medium) M7005L (Large) M7005XL (X-large) Disposable Nitril Gloves</p>

MISCELLANEOUS (Cont.)	
	<p>A44761A GM 4 Piece Case Saver</p>
	<p>A44761B GM 4 Piece Case Saver</p>
	<p>A74761D 350, 700-R4 Case Fix</p>
	<p>M460AA Vacuum Hose (7/32", 50')</p>
	<p>M462SCA Smart Connect Fitting (3/8")</p>
	<p>M463F Speedo Clip (Long Thin)</p>
	<p>M463FA Speedo Clip (Medium)</p>
	<p>M463FB Speedo Clip (Wide)</p>
	<p>M463PD Posi Lock Connector 08-10 Guage</p>
	<p>M463PA Posi Lock Connector 12-18 Guage</p>
	<p>M463PB Posi Lock Connector 18-24 Guage</p>

SPECIAL SERVICE ITEMS

MISCELLANEOUS (Cont.)	
	<p>M463D GM Universal Dust Cover</p>
	<p>M469 Silicone, Blue (3 oz)</p>
	<p>M469A Silicone, Red (3 oz)</p>
	<p>M469AB Silicone, Red RTV Aerosol</p>
	<p>M469YB Adhesive Hi Tack Spray</p>

MISCELLANEOUS (Cont.)	
	<p>T44494U Filler Tube and Dip Stick (350)</p> <p>T74494U Filler Tube and Dip Stick (700-R4)</p>
	<p>M465W Gasket Remover (15 oz) (Not for sale in California)</p>

SERVICE ITEMS

INLINE FILTERS

MAGNEFINE

The in-line auxiliary transmission filter specially designed for today's automatic transmissions.

- * Zero leak design
- * Improved filtration
- * Easy installation
- * Increased dirt holding capacity
- * Powerful magnet to attract & hold ferrous particles
- * Will withstand 200 PSI

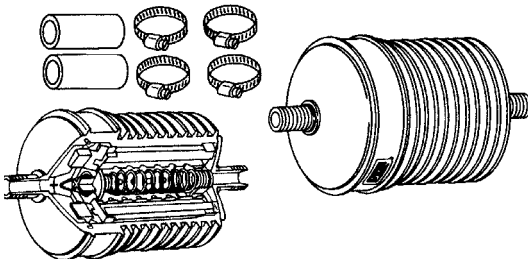

THE MAGNETIC IN-LINE TRANSMISSION FILTER KIT

Part No. **M010CA (Filter Only)**

Part No. **M010CAK (Kit)**
w/ 5/16" connectors

Part No. **M010CB (Filter Only)**

Part No. **M010CBK (Kit)**
w/ 3/8" connectors

Part No. **M010CC (Filter Only)**
w/ 1/2" connectors

SPX FILTRAN

M010SA (Filter Only)

M010SAK (Kit)
w/ 5/16" connectors

M010SB (Filter Only)

M010SBK (Kit)
w/ 3/8" connectors

RAYBESTOS

IN-LINE TRANSMISSION FILTER

- * Quality Raybestos brand
- * Easy installation using hose & clamps
- * Captures contaminants
- * Universal applications
- * For use on 5/16" lines

Part No. **M010RA (Filter Only)**

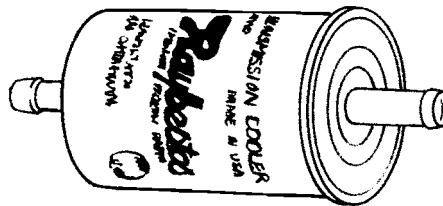

FILTER & COOLER LINE HOSE

Part No.	Size	Length
M460BA	5/16" ID	25 Ft. Roll
M460DA	3/8" ID	25 Ft. Roll
M460C	11/32" ID	5 Ft. Roll
M460CA	11/32" ID	25 Ft. Roll
M460CB	11/32" ID	50 Ft. Roll
M460EA	1/2" ID	25 Ft. Roll

COPPER TUBING

Part No.	Size	Length
M461AC-25	5/16"	25 Ft. Roll
M461AC-50	5/16"	50 Ft. Roll
M461AD-25	3/8"	25 Ft. Roll

GENERAL MOTORS, CHRYLSEY & FORD REAR WHEEL BEARING REPAIR KITS

APPLICATIONS

B350 'C' Axle Size 1.399 - 10 Bolt Light Duty	B351 'P' Axle Size 1.618 Bolt Heavy Duty
---	---

The rollers of the old bearing wear a groove into the axle. The B350 or B351 will roll on the unworn part of the axle. They are prelubricated with high temperature lithium grease, and have two seals completely sealing the bearing from the differential fluid. Enables use of worn axle shafts.

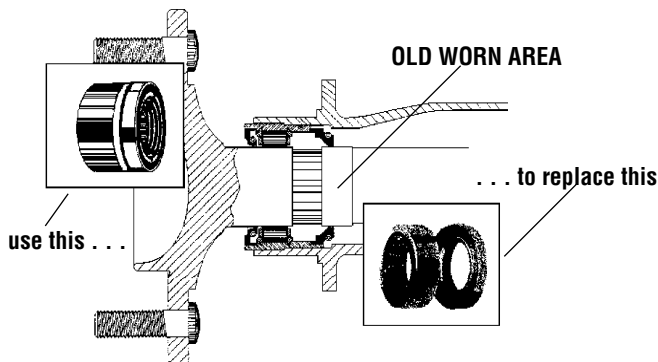

MAKE/MODEL/AXLE TYPE	YEAR	PART#
GM CARS & TRUCKS		
Buick Centurion, Electra, Estate Wagon, LeSabre, & Wildcat 'C' Axle	70-88	B350
'P' Axle	73-88	B351
Cadillac DeVille, Fleetwood Brougham, Seville 'C' Axle	75-88	B350
Cadillac Commercial, Fleetwood Sedan, & Limo 'P' Axle	77-88	B351
Chevrolet Camaro, Chevelle, Chevy II, Malibu, Nova, Vega, Van, Blazer, Suburban, Chevrolet & GMC Trucks 1/2 Ton & S10, S15 'C' Axle	64-88	B350
'P' Axle	64-88	B351
OLDSMOBILE		
Delta 88, Ninety Eight, Delmont 88, Custom Cruiser, Cutlass, F-85, Vista Cruiser, Omega & Starfire 'C' Axle	68-88	B350
'P' Axle	73-88	B351
PONTIAC		
Catalina, Bonneville, Grandville, Astre, Sunbird, Firebird, Grand Prix, LeMans, Tempest, Ventura II & Phoenix 'C' Axle	70-88	B350
'P' Axle	71-88	B351
CHRYLSEY, DODGE, PLYMOUTH		
All models - full size and compact. 8-1/4" Ring Gear, 10" Brake	75-88	B350
8-1/4" Ring Gear, 11" Brake	71-88	B351
9-1/4" Ring Gear	71-88	B351
Trucks - 1/2 Ton 8-3/8" & 9-1/4" Ring Gear	72-88	B351
FORD PASSENGER		
Granada, Fairmount, LTD II, Maverick, Mustang, Thunderbird, Lincoln & Mercury Marquis, Monarch, Montego, Zephyr, Capri II, Comet & Cougar 7-1/2" & 8-1/2" Ring Gear - Integral Rear End	67-88	B350
Trucks, Ranger & Bronco II 7-1/2" Ring Gear	82-88	B350
1/2 Ton & 3/4 Ton Sterling Axle	83-88	B351









FILTERS / BEARINGS

CHRYLSEY FRONT WHEEL DRIVE INNER AXLE BEARINGS

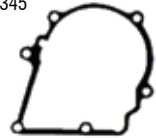













	79-89	Omni, Horizon - all w/1.6 & 1.7 engine	40mm Bore	B254	4271389
	79-84	Aries, Reliant	76mm O.D.	B254	5212541
	82-84	LeBaron, New Yorker, 'E' class	33mm Wide	B254	-
	84-Up	LeBaron, GT, S, 'K' bodies, 'E' class, T-115	42mm Bore	B250	4397498
			76mm O.D. 40mm Wide		

TRANSFER CASE ADAPTER GASKETS











TRANSMISSION TO ADAPTER GASKETS

<p>AOD/E-W BW-1345, 1356, 4404, 4405 DANA TC-28</p>  <p>76305</p>	<p>A727/904 A998/999 NPG-203, 205, 208, 241</p>  <p>22305AB</p>	<p>C6 BW-1345, 1356, 4406, 4407 NPG-203, 205, 208</p>  <p>36305</p>	<p>C4, C5 NPG-203, 208 BW-1345</p>  <p>26305</p>	<p>E40D BW-1345, 1356, 4407</p>  <p>36305E</p>
<p>A4LD/4R44E/4R55E C3 BW-1345, 1350, 1352, 1354, 4404, 4405 DANA TC-28</p>  <p>56305</p>	<p>TH-400 NPG-203, 205, 208 BW-1370, 4470</p>  <p>34305</p>	<p>TH-400 NPG-203, 205, 208 BW-1370, 4470</p>  <p>114348</p>	<p>TH-700-R4/4L60E TH-350/C NPG-203, 205, 207, 208, 231C BW-1370, 4401, 4470, 4472</p>  <p>44348</p>	

ADAPTER TO TRANSFER CASE GASKETS

<p>DANA 18</p>  <p>Available only in Kit TSK20</p>	<p>DANA 18, DANA 20</p>  <p>Available only in Kit TSK20</p>	<p>NPG-203</p>  <p>301304</p>	<p>NPG-203, 205, 208, 241</p>  <p>331304B w/ cut out removed</p>	<p>NPG-205</p>  <p>311304</p>
<p>NPG-203</p>  <p>301304A</p>	<p>BW-1345, 1350, 1354, 1356, 4406, 4407 NPG-208</p>  <p>325304</p>	<p>NPG-205</p>  <p>311304A</p>	<p>NPG-207, 231C BW-4472</p>  <p>351304</p>	<p>BW-1345, 1350, 1352, 1354, 4404, 4405 DANA TC-28</p>  <p>315304</p>
<p>NPG-205, 208</p>  <p>Replaced by 331304B</p>	<p>NPG-205, 208</p>  <p>331304A</p>	<p>QUADRA-TRAC</p>  <p>Available only in Kit TSKQUAD</p>	<p>NPG-208</p>  <p>331305</p>	

MISCELLANEOUS GASKETS

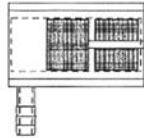
MISCELLANEOUS GASKETS			
<p>NPG-242 OUTPUT BEARING INSPECTION COVER GASKET</p>  <p>12305J</p>	<p>QUADRA-TRAC REDUCTION CASE COVER GASKET</p>  <p>Available only in Kit TSKQUAD</p>	<p>DANA 300 PAN GASKET</p>  <p>Available only in Kit TSK300</p>	<p>NPG-203, 205 INPUT GEAR BEARING RETAINER GASKET</p>  <p>311305</p>
<p>NPG-203, 205 PTO COVER GASKET</p>  <p>301305</p>	<p>NPG-203, 205 FRONT OUTPUT BEARING RETAINER GASKET</p>  <p>Available only in Kit TSK203 or TSK205</p>	<p>NPG-205 OUTPUT SHAFT BEARING RETAINER GASKET</p>  <p>311306</p>	<p>NPG-203 DIFF. HOUSING GASKET</p>  <p>301307</p>
<p>NPG-203 HOUSING TO CHAIN COVER GASKET</p>  <p>301306</p>	<p>NPG-205 IDLER COVER GASKET</p>  <p>311307</p>	<p>NPG-205 FRONT BEARING RETAINER GASKET</p>  <p>311308</p>	<p>FILTER NPG-231, 241</p>  <p>351012</p>

ADAPTER GSKTS

COOLERS & RELATED ITEMS

<p style="text-align: center;">Coolers (Hayden)</p> <p>OC-1401 12,000 gww (12 1/2 x 5 x 3/4)</p> <p>OC-1402 16,000 gww (15 1/2 x 5 x 3/4)</p> <p>OC-1403 18,000 gww (12 1/2 x 7 1/2 x 3/4)</p> <p>OC-1404 22,000 gww (15 1/2 x 7 1/2 x 3/4)</p> <p>OC-1405 26,000 gww (15 1/2 x 10 x 3/4)</p> <p>OC-1676 18,000 gww (Transaver Plus) (11 x 4 x 3/4)</p> <p>OC-1677 20,000 gww (Transaver Plus) (11 x 5 1/2 x 3/4)</p> <p>OC-1678 24,000 gww (Transaver Plus) (11 x 7 3/4 x 3/4)</p> <p>OC-1679 30,000 gww (Transaver Plus) (11 x 9 7/8 x 3/4)</p> <p>OC-1260 Allison AT540 HD (12 x 24 x 1 1/2)</p> <p style="text-align: center;">Coolers (Tru-Cool High Efficiency)</p> <p>OC-4707 20,000 gww (w/ 5/16" Inverted Flare Fitting)</p> <p style="padding-left: 20px;">* Use of Steel Lines Recommended</p> <p>OC-4711 20,000 gww (w/ 3/8" Inverted Flare Fitting)</p> <p style="padding-left: 20px;">* Use of Steel Lines Recommended</p> <p>OC-4739 40,000 gww (w/ 3/8" Inverted Flare Fitting)</p> <p>OC-M7B HD V8 Vehicles, HP Applications (20,500 BTU)</p> <p style="padding-left: 20px;">(Uses 1/2" NPT Fitting)</p> <p>OC-H7B HD Recreational / Industrial Vehicles (29,200 BTU)</p> <p style="padding-left: 20px;">(Uses 1/2" NPT Fitting)</p> <p style="text-align: center;">Coolers (Tru-Cool Low Pressure)</p> <p>OC-4451 11,500 gww (4 x 11 x 3/4) (11/32" Hose Barb)</p> <p>OC-4452 14,500 gww (5 3/4 x 11 x 3/4) (11/32" Hose Barb)</p> <p>OC-4454 18,000 gww (7 1/4 x 11 x 3/4) (11/32" Hose Barb)</p> <p>OC-4490 22,000 gww (12 x 11 x 3/4) (11/32" Hose Barb)</p> <p>OC-4588 19,000 gww (5 3/4 x 11 x 1 1/2) (11/32" Hose Barb)</p> <p>OC-4589 24,000 gww (8 x 11 x 1 1/2) (11/32" Hose Barb)</p> <p>OC-4590 28,000 gww (11 x 11 x 1 1/2) (11/32" Hose Barb)</p> <p style="text-align: center;">Cooler Mounting Kits</p> <p>OC-K210 Cooler Mount Kit (Plastic Straps) (Hayden)</p> <p>OC-1201 Cooler Mount Kit (Plastic Straps) (Tru-Cool)</p> <p>OC-K253 Cooler Mount Kit (Metal Straps) (Hayden)</p> <p>OC-1101 Cooler Mount Kit (Metal Straps) (Tru-Cool)</p> <p>OC-1150 Cooler Mount Kit (Shock Absorber Mounts)</p> <p style="text-align: center;">Inline Filters & Kits</p> <p>M010SA 5/16" Inline Filter (SPX)</p> <p>M010SAK 5/16" Inline Filter Kit (SPX)</p> <p>M010CAK 5/16" Inline Filter Kit (Allomatic)</p> <p>M010RA 5/16" Inline Filter (Raybestos)</p> <p>M010BA 5/16" Inline Filter (Bryco)</p> <p>M010CB 3/8" Inline Filter (Allomatic)</p> <p>M010CBK 3/8" Inline Filter Kit (Allomatic)</p> <p>M010SB 3/8" Inline Filter (SPX)</p> <p>M010SBK 3/8" Inline Filter Kit (SPX)</p> <p>M010RB 3/8" Inline Filter (Raybestos)</p> <p>M010SCK 1/2" Inline Filter Kit (SPX)</p> <p style="text-align: center;">Cooler Lines</p> <p>M461C Copper Tubing, 5/16" (25' Roll)</p> <p>M461 Copper Tubing, 5/16" (50' Roll)</p> <p>M461A Steel Cooler Line, 5/16" (60")</p> <p>M461B Steel Cooler Line, 3/8" (60")</p>	<p style="text-align: center;">Cooler Hoses</p> <p>M460BA Cooler Line Hose, 5/16" (25' Roll)</p> <p>M460C Cooler Line Hose, 11/32" (4 1/2' Section)</p> <p>M460CA Cooler Line Hose, 11/32" (25' Roll)</p> <p>M460DA Cooler Line Hose, 3/8" (25' Roll)</p> <p>M460E Cooler Line Hose, 1/2" (10' Section)</p> <p>M460EA Cooler Line Hose, 1/2" (25' Roll)</p> <p>M460HC Hose Clamp, 5/16" to 7/8" (Screw Type)</p> <p style="text-align: center;">Cooler Etc. Flush</p> <p>M465KD Kooler Kleen (Dr Tranny)</p> <p>M465PK Power Kleen (For Non Water Based Line Flushers &</p> <p style="padding-left: 20px;">Part Washers) (Dr Tranny)</p> <p>M465KT Kool-It Radiator Treatment (Lubegard)</p> <p>M465KTP Kool-It Radiator Treatment & Flush (Lubegard)</p> <p>M465SBF Synthetic Trans Flush (Life Automotive)</p> <p>M465F18 Trans Cooler Flush (Life Automotive)</p> <p>M465FA Import Adapter for M465F18</p> <p>M465FB 3/8" Adapter for M465F18</p> <p>M465FK Trans Cooler Flush Line Fitting (Life Automotive)</p> <p>M465GTF Trans Flush (Wynn's)</p> <p style="text-align: center;">Transmission Flush & Additive Combo</p> <p>M465LPK Lubegard (Red) & Flush Pack</p> <p>M465BP Lubegard (Black) & Flush Pack</p> <p>M465LMVP Lubegard (Green - Mercon) & Flush Pack</p> <p>M465LPP Lubegard (Platinum) & Flush Pack</p> <p>M465SBFK Smart Blend (Red) & Flush Pack</p> <p style="text-align: center;">Cooler Line Fittings Kits</p> <p>OC-K252 Fitting Kit, Ford</p> <p>OC-393 Fitting Kit, GM 1/2" x 20mm</p> <p>OC-390 Fitting Kit, GM (91-Up w/ Longer Cooler Lines)</p> <p>OC-391 Fitting Kit, Jeep w/ 5 to 8 Lines (45 Degree Angle) ..</p> <p>OC-392 Fitting Kit, Jeep, Dodge (3/8" Splicers)</p> <p style="text-align: center;">Cooler Installation Fittings</p> <p>OC-K250 Quik-Connect (Fits Most 5/16" w/ 1/2 x 20 Threads)</p> <p>OC-K252 Ford w/ 1/4", 3/8" NPT Fittings</p> <p>OC-390 GM, Ford, Jeep w/ 5/8" x 18 Inverted Flare</p> <p>OC-391 Jeep w/ 5/8" x 18 SAE 45 Degree Fittings</p> <p>OC-392 Dodge, Jeep 3/8" x 3/8" Hose Splicers</p> <p>OC-393 GM w/ 1/2" x 20 Inverted Flare (Full Thread)</p> <p>OC-9139 Compression Fitting w/ 5/16" Hose Barb</p> <p>OC-9140 Compression Fitting w/ 3/8" Hose Barb</p> <p>M462C Fitting, 350, 350C</p> <p>74996 Fitting, 4L60E 82-95 (5/16")</p> <p>74996B Fitting, 4L60E 96-Up (5/16")</p> <p>34996EA Fitting, 4L80E Quick Connect (Cooler Line to Case) ..</p> <p>M462M Case Fitting (5/16" Tubing)</p> <p>M462MA Case Fitting & Union (5/16" Tubing)</p> <p>A12996 Case Fitting, Chrysler (5/16" Tubing)</p> <p>M462FE Cooler Line Compression on to 3/8" Hose Barb</p> <p>M462FD Cooler Line Compression on to 5/16" Hose Barb</p> <p>74996A Retaining Clip 4L60E, 4L80E (3/8" Push In)</p> <p>T-8010 Transmission Temperature Gauge</p>
--	---

<p style="text-align: center;">Additives (10 oz Bottle)</p> <p>M465L Lubegard (Red)</p> <p>M465B Lubegard (Black)</p> <p>M465LMV Lubegard (Green - Mercon)</p> <p>M465LP Lubegard (Platinum).</p> <p>M465SB Smart Blend (Red).</p> <p>M465SBA Smart Blend (Black)</p> <p>M465SBV Smart Blend (Blue - Mercon)</p> <p style="text-align: center;">Additives (Other)</p> <p>M465LG-5 Lubegard (Red) (40 lb Pail)</p> <p style="text-align: center;">Additives & Transmission Flush Combos</p> <p>M465LPK Lubegard (Red) & Flush Pack</p> <p>M465BP Lubegard (Black) & Flush Pack</p> <p>M465LMVP Lubegard (Green - Mercon) & Flush Pack</p> <p>M465LPP Lubegard (Platinum) & Flush Pack</p> <p>M465SBFK Smart Blend (Red) & Flush Pack</p> <p style="text-align: center;">Anti Rust</p> <p>M465AR Trans Prep II (Anti Rust) (Life Automotive).</p> <p style="text-align: center;">Assembly Lube</p> <p>M465TJ Transjel, Red (SPX)</p> <p>M465TJG Transjel, Gold (SPX)</p> <p>M465TG Assemblee Goo, Green (Dr. Tranny)</p> <p>M465JA Assemblee Luub (Dr. Tranny)</p> <p>M465TP Trans Prep, Blue (Life Automotive)</p> <p>M465DT Assembly Lube, Blue (Dynatex)</p> <p>M465R Assembly Lube (8 oz) Blue (Raybestos)</p> <p>M465TJS Assembly Lube Stick (SPX)</p> <p style="text-align: center;">Assembly Lubricants</p> <p>M465JB Trans Life Prep 3 (Life Automotive).</p> <p>M465AA Assembly Aid, For Small Parts (Life Automotive).</p> <p>M465SLS O-Ring & General Purpose Lube (Sonnax).</p> <p>M465VS Valve & Assembly Lubricant (12 oz) (Lubegard)</p> <p>M465VSG Valve & Assembly Lubricant (Gallon) (Lubegard)</p> <p>M465AP-4 All Purpose Lubricant (4 oz) (Lubegard)</p> <p>M465AP-8 All Purpose Lubricant (8 oz) (Lubegard)</p> <p>M465LA All Purpose Lubricant (4 oz) (Lubegard)</p> <p>M465S Spray Lubricant (Trans Lube)</p> <p>M469S Spray Lubricant (Am Rep).</p> <p style="text-align: center;">Cooler Etc. Flush</p> <p>M465KD Kooler Kleen (Dr Tranny)</p> <p>M465PK Power Kleen (For Non Water Based Line Flushers & Part Washers) (Dr Tranny).</p> <p>M465KT Kool-It Radiator Treatment (Lubegard)</p> <p>M465KTP Kool-It Radiator Treatment & Flush (Lubegard)</p> <p>M465SBF Synthetic Trans Flush (Life Automotive)</p> <p>M465F18 Trans Cooler Flush (Life Automotive).</p> <p>M465FA Import Adapter for M465F18.</p>	<p style="text-align: center;">Cooler Etc. Flush</p> <p>M465FB 3/8" Adapter for M465F18</p> <p>M465FK Trans Cooler Flush Line Fitting (Life Automotive).</p> <p>M465GTF Trans Flush (Wynn's)</p> <p style="text-align: center;">Engine</p> <p>M465E Engine Oil Supplement (10 oz) (Lubegard)</p> <p>M465EA Engine Oil Supplement (15 oz) (Lubegard)</p> <p>M465EL Engine Assembly Primer Kit (Life Automotive).</p> <p>M465MP2 Engine Oil Treatment (Mega Power)</p> <p>M465MP3 Engine Power Penetration (Mega Power).</p> <p>M465MT8 Metal Treatment (8 oz) (Muscle Products) (Automatics & Standards)</p> <p style="text-align: center;">Gear Fluid Supplements (Standard Trans)</p> <p>M465G Gear Fluid Supplements (Lubegard)</p> <p>M465GJ J-Lube Gear Oil (JOJOBA)</p> <p style="text-align: center;">Limited Slip</p> <p>M465D Limited Slip Supplement (Lubegard).</p> <p style="text-align: center;">Power Steering</p> <p>M465P Power Steering Fluid (10 oz) (Lubegard)</p> <p>M465PA Power Steering Fluid (32 oz) (Lubegard)</p> <p>M465PS Power Steering Fluid Protectant (4 oz) (Lubegard).</p> <p>M465PF Power Steering Flush (Muscle Products).</p> <p style="text-align: center;">Shudder Fixes</p> <p>M465HA Shudder Fix (2 oz) (Dr Tranny)</p> <p>M465SBE Shudder Fix (2 oz) (Life Automotive)</p>
---	--

SERVO BORE REPAIR TOOL KITS

The Servo Bore Repair Kit is patented tool system for the repair of worn servo rod bores. All of the kits use the same basic process in which the rod bore is enlarged with two reamers. An oversized sleeve is then installed. The kits require no special machinery. After you purchase the master kit, all you then need is a drill, cutting oil and Loctite. The system restores the rod bore to it's original dimension, allowing you to use original equipment servo rods with *no more crossleaks*. All kits are produced to the same quality standards. Kits initially contain sleeves for repair, but additional sleeves must be purchased separately.

- Provides in shop repair of worn servo rod bores
- Eliminates outsourcing to repair cases
- Restores servo rod bore integrity to OEM specifications

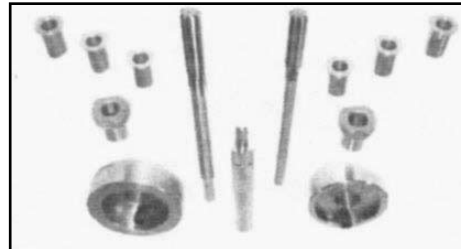

The Servo Rod Bore Repair Kit is available for these nine transmissions

Transmission Repair Kit	Part No.	Replacment Sleeves	Part No.
180/4L30E	T-9210	180/4L30E	T-9210-SL
400/4L80E	T-9211	400/4L80E	T-9211-SL
A4LD/E	T-9212	A4LD/E	T-9212-SL
5R55N/S/W	T-9213	5R55N/S/W (Overdrive)	T-9213-SL
AOD	T-9214	5R55N/S/W (Intermediate)	T-9213A-SL
AODE/4RN70W	T-9215	AOD/E	T-9210-SL
CD4E	T-9216	CD4E	T-9216-SL
AX4S/N (Overdrive)	T-9217	AX4S/N (Overdrive)	T-9217-SL
AX4S (Intermediate)	T-9218	Ax4S (Intermediate)	T-9218-SL

ZF FLUIDS

TYPE	MAKE	DECAL (color)	PART #	MODELS	
5HP18	All	Black	M465YD (Dextron)	1056-000-092/093 & 088 & lower	Black Decal M465YD (Dextron) Transmission Fluid 5HP18/18A w/black tag
5HP18	All	Green	M465ZF5	1056-000-090/091 & 094 & Up	
5HP18A	All	Black	M465YD (Dextron)	1056-020-All	Black Decal Z465ZFB Transmission Fluid (20 litre container) 5HP30 w/black tag
5HP19	All	Green	M465ZF5	1060-000-All	
5HP19FL	All	Green	M465ZF5	1060-030-All	Green Decal M465ZF5 Transmission Fluid (20 litre container) ZF5HP18, 19, 24, 30 w/green tag
5HP19FLA	All	Green	M465ZF5	1060-040-All	
5HP19HL	All	Green	M465ZF5	1060-050-All	NOTE: Do NOT mix M465ZF5 & M465ZFB
5HP19HLA	All	Green	M465ZF5	1060-060-All	
5HP24	All	Green	M465ZF5	1058-000-All	
5HP24A	All	Green	M465ZF5	1058-020-All	
5HP30	BMW	Black	M465ZFB	1050-000-007/010/011/015/029/030	
5HP30	BMW	Green	M465ZF5	1055-000-016/017/019/026/&031 & Up	
5HP30	Bentley	Green	M465ZF5	1050-000-All	
5HP30	RR	Green	M465ZF5	1050-000-All	

HONDA HARNESS KITS

Part No. 60445EAK	Part No. 60445EK	Part No. 60445HAK	Part No. 60445YK
			
Part No. 70445AAK	Part No. 70445AK	Part No. 80445AAEK	Part No. 80445AAK
			
Part No. 80445AEK	Part No. 80445AK		
			

Hayden Transmission Coolers

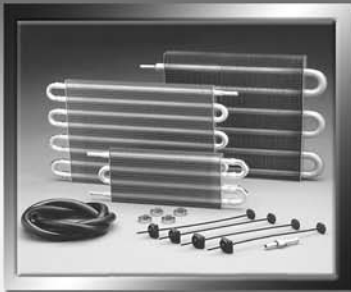

Transaver Transmission Oil Cooler

- High efficiency turbulators for maximum heat dissipation
- 100% pressure tested at 150 PSI for quality assurance
- Every joint is ultrasonically brazed for long life and reliability



Transaver Plus Transmission Oil Cooler

- Internal turbulation for highly efficient heat transfer
- Pre-drilled mounting plates for easy installation
- Four sizes to fit any application including trucks & motor homes



Remote Transmission Cooling System

- Available in both tube & fin and plate & fin designs
- Units are preassembled and can be mounted remotely or adjacent to the radiator
- Keeps transmission cool under extreme conditions
- Ideal for trucks, RVs, SUVs or where radiator mounting is not possible



MISCELLANEOUS SECTION INTERCHANGE

REF. #	PART #	REF. #	PART #	REF. #	PART #	REF. #	PART #	REF. #	PART #
13590	331304A	35101K	44134K	96-117A	M462AC	96-206	BOX-602	96-325K	M465LPK
13595	351304	35104K	44124K	96-125	M463GF	96-208	T76996	96-326	M465VS
13596	331304B	35176A	M463SB	96-126	M463GG	96-208A	T86996	96-326-1	M465VSG
35176	M463SA	35226	M463F	96-127	M463CL	96-208B	T56996	96-327	MBK-249
105-319	301306	35226A	M463FA	96-128	M463CJ	96-209	M463GN	96-328	A34783A
105-320	331304A	35226B	M463FB	96-129	M462JB	96-209A	M463GP	96-328A	D34783
105-321	325304	35700X	R44022HD	96-130	M462JC	96-212	M463GM	96-328B	D34784
105-323	315304	35A-130	74448AK	96-131	M474GC	96-213K	76496K	96-329	A74778
105-324	311304A	35R-130	74448K	96-132	M462C	96-215C	M99125I	96-330	A36783
105-324A	331304	36305K	36126K	96-132A	M462GB	96-216C	M99126I	96-330A	A36783A
105-325	345304	36320HP	N36022C	96-132B	M462DC	96-217C	M99127I	96-331	TC-36605-01
12751K	12126K	36505K	36130K	96-132C	M462DD	96-218C	M99128I	96-332	M465SBE
12905FX	N12022D	36505X	36130X	96-133	M462PB	96-225	M470CA	96-333	M465SBG
18306BK	114126C	53205K	76124K	96-135	M460HCA	96-226	M470CB	96-334	M465LSR
18507AK	114130K	53305AK	76126AK	96-135A	M460HC	96-227	M470CC	96-336	M465KT
22594K	22126K	53305K	76126K	96-136	M462FF	96-228	M470CD	96-336A	M465KRF
22825AX	N22022C	53320AX	N76020G	96-138	M462JD	96-235	A44839	96-336B	M465KE
26305AK	26126K	53320X	R76020K	96-140A	44494D	96-250M	M99135I	96-336K	M465KTP
26320FK	R26022K	53405AK	76128AK	96-140B	T44494R	96-251M	M99136I	96-337	M465LSRG
30A-100	LU1	53505AK	76128BK	96-141	44490	96-252M	M99137I	96-340	M465TAT
30A-200	36447B	61101K	74130K	96-145	M461AB	96-300	M465MT8	96-341	M465FS
30A-226	LU1-4226	61103K	74136K	96-145A	M461BC	96-301	M465MLS	96-343	M465LS
30A-227	LU1-4227	61105DK	74128AK	96-146	M461A	96-303	M463GK	96-343E	M465LSX
30A-228	LU1-4228	61109CK	74120AK	96-146A	M461B	96-303A	M463GL	96-350VB	VB-101
30A-229	LU1-4229	61700W	N74020C	96-147	M462NB	96-304	M465TP	96-360C	M469BB
30A-230	LU1-4230	61700X	N74020AK	96-147A	M462NC	96-304A	M465AA	96-361	M469R
30A-231	LU1-4231	6205K	76128K	96-148	M461AC-25	96-306	M465F18	96-362	M469-518
30A-233	LU1-4233	73105AK	36132EK	96-149	M461BC-25	96-306F	M465FB	96-364	M469LGS
30A-240	GM-RELAY	73105K	36132K	96-150	26164K	96-306K	M465FK	96-365	M478-609
30A-320	36447E	73205K	36124K	96-151	M469B	96-306S	M465F14	96-366	M478-242
30A-322	36447IA	73605K	36120K	96-152	M469BLA	96-307	M468	96-366E	M478-242S
30A-324	36447C	73714CK	36145K	96-153	M463EA	96-308	M463N	96-367	M478-271A
30A-324A	36447CA	81-1000	44450U	96-156G	M465TJG	96-309	M465KD	96-367E	M478-271S
30A-325	76416A	81-1001	54450U	96-156L	M465TG	96-309A	M465LTF	96-369	M478
30A-340U	A34447	81-1002	T54450C	96-156LB	M465TB	96-309B	M465EF	96-369E	M478-S
30A-342	74447E	81-1003	T54450D	96-156S	M465SLS	96-311	M465SBF	96-370	M478-T
30A-344	34447E	81-1004	T54450A	96-160	M474FA	96-312	M465JB	96-372	M478-G
30A-346	14447C	81-2000	D79450S	96-160M	M474FB	96-313	M465SB	96-374	M478-CPR
30A-348	84447GC	81-2003	D79450E	96-161	M464CB	96-313A	M465SBA	96-374E	M478-CPRS
30A-401A	PR204	81-2005	D69450B	96-163B	M464GF	96-313B	M465SBV	96-389	OC-K252
30A-401B	PR205	81-881	T64450A	96-163N	M474GB	96-313C	M465SBT	96-390	OC-390
30A-401C	PR206	81-909B	S74451H	96-164	M464GD	96-313D	M465SBS	96-391	OC-391
30A-402A	PR209	81-909C	44451B	96-169	A74779M	96-313E	M465SBD6	96-392	OC-392
30A-402B	PR210	81-909E	S74451G	96-171	M464MA	96-313K	M465SBFK	96-393	M462FE
30A-402C	PR211	81-909S	S74451E	96-172	M464MB	96-314	M465J	96-394	M462FD
30A-404A	PR201	81-909T	T57451	96-175	M464GM	96-315D	CRA-ZD	96-395	M465FA
30A-404B	PR202	81-930	44452B	96-177	M464GK	96-315S	CRA-Z	96-396	36996A
30A-406C	PR207	81-931	44452C	96-178	M464GE	96-316	M473S	96-396A	36999C
30A-408C	PR208	81-932	44452A	96-180	M471Y	96-318	M465LF	96-400	M465ZFB
32100K	54126AAK	81-951	T44450	96-185	D46494	96-319	M465HA	96-401	M465ZF5
32101K	54134AK	81-971A	T44450A	96-185B	D49494B	96-320	M465LA	96-440	84996AA
32104K	54126AK	81-982	86450A	96-189	M473MG-12	96-321	M465EA	96-440B	74996A
32109K	54120BK	81-983	86450	96-190	M473BF-12	96-321K	M465EAP	96-441	84996
32700X	N54022AK	8314HR	R114022HP	96-191	M473CA-12	96-322	M465D	96-460	74996B
32711L	M010SB	96-100	M462F	96-192	M473G-12	96-323	M465P	96-462	86996H
32711M	M010SA	96-101	M462FA	96-193	M461AC-50	96-323B	M465PS	96-480	34996EA
32711R	M010RA	96-102	M462PA	96-194	M473B-12	96-323K	M465PSP	96-480K	S34496K
32711S	M010CA	96-103	M462FB	96-195	M472-50	96-324	M465G	96-500H	M463PF
32711T	M010CB	96-105	M463TA	96-195C	M472-50C	96-325	M465L	96-500P	M463PA
32711W	M010CC	96-106	M463TB	96-196	M472-75	96-325-5	M465LG-5	96-500TK	M463PK
34305AK	34128B	96-110	M462GC	96-197	M472-100	96-325A	M465B	96-501	121996
34305CK	34126D	96-111	M463EB	96-198	M472-75S	96-325AK	M465BP	96-518	T22996A
34325X	R34022HD	96-112	M463GB	96-199	M472-100C	96-325B	M465LMV	96-518B	T22996B
34405AK	34124H	96-114	M463GA	96-200C	A36761C	96-325BK	M465LMVP	96-518C	22996C
34405K	34124K	96-116	M463GE	96-200D	A36761D	96-325C	M465LP	96-600	M7005L
35100K	44126K	96-117	M462AB	96-204	BOX-601	96-325CK	M465LPP	96-601	M7005XL

MISCELLANEOUS SECTION INTERCHANGE

REF. #	PART #	REF. #	PART #	REF. #	PART #	REF. #	PART #	REF. #	PART #
96-602	M7005M	R34404X	R34104HP	T-8086-23	07X208	T-9083H	SS-A4LD-2	T-9090	PR234
96-604	M464CA	R34504X	R34100HP	T-8086-24	07X209	T-9083J	SS-4T60E-PWM	T-9125	TT-MH
96-9113	M465C	R34604X	R34116HP	T-8086-25	07X210	T-9083L	SS-MKM	T-9130	T76496AK
96-9173	M465BKN	R35102X	R44104HP	T-8086-26	12X201	T-9083M	SS-M4L60E-PWM	T-9150	SS-BTM
96-9173C	M465BKSC	R35103X	R44106HP	T-8086-27	12X202	T-9083N	SS-M4R44E-EPC	T-9151	SS-BTP
D61141	D34490	R35109X	R74114HP	T-8086-28	13X201	T-9083P	SS-M4R44E-SS	T-9153	SS-PS
DP-1	T-3020	R36304X	R36106HP	T-8086-29	13X202	T-9083Q	SS-M42RE-GPS	T-9154	SS-SJ
H105	M460C	R36304X	R36106HP	T-8086-30	13X203	T-9083Z	SS-SS	T-9210	T-9210
H125	M460CA	R36404X	R36108BHP	T-8086-31	14X201	T-9084	SS-AXOD	T-9210-SL	T-9210-SL
H150	M460CB	R36504AX	R36110HP	T-8086-32	14X202	T-9084-1	SS-F-7	T-9211	T-9211
H225	M460BA	R48750X	R32106HP	T-8086-33	14X203	T-9084-1M	SS-APC	T-9211-SL	T-9211-SL
H325	M460DA	R48760CX	R32108AHP	T-8086-34	14X204	T-9084-2	SS-4L30E	T-9212	T-9212
H525	M460EA	R53204AX	R76104AHP	T-8086-35	15X201	T-9084-3	SS-L	T-9212-SL	T-9212-SL
K10200	ORMK	R53204X	R76104HP	T-8086-36	16X201	T-9084-4	SS-KM	T-9213	T-9213
K10205	SSPP	R53304X	R76106HP	T-8086-37	13X204	T-9084-5	SS-KML	T-9213A-SL	T-9213A-SL
K125HP	12008CFHP	R53404X	R76108AHP	T-8086-38	03X204	T-9084-6	SS-T	T-9213-SL	T-9213-SL
K215C	M99125K	R61100AX	R74110AHP	T-8086-38A	03X206	T-9084-7	SS-42RH	T-9214	T-9214
K216C	M99126K	R61102X	R74116HP	T-8086-38B	03X207	T-9084-9	SS-ZF4HP22	T-9215	T-9215
K217C	M99127K	R61104AX	R74108AHP	T-8086-40	04X206	T-9084-10	SS-42RE	T-9216	T-9216
K218C	M99128K	R61108AX	R74100CHP	T-8086-41	04X207	T-9084-11	SS-SATURN	T-9216-SL	T-9216-SL
K225HP	22008CFHP	R66102EX	R84104GHP	T-8086-42	04X208	T-9084-12	SS-JR403E	T-9217	T-9217
K228	M470C	R66103CX	R84106BHP	T-8086-43	06X204	T-9084-13	SS-4F20E	T-9217-SL	T-9217-SL
K235	A44839K	R66103DX	R84126ABHP	T-8086-44	07X212	T-9084-14	SS-L4T80E	T-9218	T-9218
K250M	M99135K	R66104EX	R84100GHP	T-8086-45	07X213	T-9084-17	SS-4R70W	T-9218-SL	T-9218-SL
K251M	M99136K	R66106AX	R84108AHP	T-8086-46	02X201	T-9084-18	SS-A340E	T-9260	T-FM-01K
K252M	M99137K	R72740X	R92100BHP	T-8086-47	09X201	T-9084-19	SS-A541E	T-9260-1	T-FM-01K-1
K2600HP	26008CFHP	R72750X	R92104HP	T-8086-48	09X202	T-9084-20	SS-F4E-111	T-9405	T-9405
K2800HP	114008FHP	R72760X	R92114HP	T-8086-49	09X203	T-9084-22	SS-RE4F02A	TS102	SS-ST
K3200MHP	54008BFHP	R73104X	R36112HP	T-8086-50	09X204	T-9084-23	SS-RE4R01A	TV030	SS-SSV
K32711L	M010SBK	R73204X	R36104EHP	T-8086-51	09X205	T-9084-24	SS-A341E	TV031	SS-MSTV
K32711M	M010SAK	R73504X	R36110EAHP	T-8086-52	04X209	T-9084-25	SS-VW		
K32711S	M010CAK	R73604AX	R36100EAHP	T-8086-53	03X203	T-9084A	SS-4T60E-L		
K32711T	M010CBK	R73604X	R36100HP	T-8086-54	01X206	T-9084B	SS-G4EAT		
K3400EHP	34008EFHP	R86100X	R14104AHP	T-8086-55A	07X218	T-9084C	SS-42LE		
K3400HP	34008AFHP	R86102X	R14110AHP	T-8086-56	02X202	T-9084D	SS-4T80E		
K3500HP	44008DFHP	R86104X	R14106AHP	T-8086-57	01X207	T-9084E	SS-4T40E		
K35909	T44451DC	R86106X	R14108AHP	T-8086-60	03X208	T-9084F	SS-A4LD		
K3600HP	36008BFHP	R86108X	R14112AHP	T-8086-61	04X211	T-9084G	SS-LE40D		
K4800HP	32008AFHP	T-0012-TP	T-0012-TP	T-8086-62	04X212	T-9084H	SS-L4L80E		
K5300BHP	76008BFHP	T-0012-TPHCA	T-0012-TPHC	T-8086-63	07X219	T-9084J	SS-4EAT		
K5300FHP	76008EAHP	T-8085	TX2000	T-8086-64	07X220	T-9084K	SS-4L60E		
K5300GHP	76008GFHP	T-8085M	TX2006A	T-8086-65	12X203	T-9084KU	SS-4L60EU		
K5300HP	76008AFHP	T-8085Z	ZCAL	T-8086-66	12X204	T-9084L	SS-LAXODE		
K6100EHP	74008EFHP	T-8086-1	01X201	T-8086-67	03X209	T-9084M	SS-N4AEL		
K6100HP	74008BFHP	T-8086-2	01X202	T-8086-68	16X202	T-9084N	SS-4R44E		
K61909	74451	T-8086-3	01X204	T-8086-69	10X201	T-9084P	SS-CD4E		
K61909T	T74451C	T-8086-4	01X203	T-8086-70	15X202	T-9084Q	SS-AX4N		
K6600HP	84008GHP	T-8086-5	01X205	T-8086-71	09X205	T-9084R	SS-4L80E		
K7200HP	92008AFHP	T-8086-6	03X201	T-8086-72	06X201	T-9084S	SS-AODE		
K7300DHP	36008EDHP	T-8086-7	03X202	T-8086-73	12X205	T-9084T	SS-AXODE		
K7300HP	36008EFHP	T-8086-8	04X201	T-8086-74	13X205	T-9084U	SS-4T60E		
K8600HP	14008AHP	T-8086-9	04X202	T-8088	T-8088	T-9084V	SS-F4EAT		
K96-209B	M463GQ	T-8086-10	04X203	T-9007F	TEST-E40D	T-9084W	SS-E40D		
KB-120	M464K-120	T-8086-11	04X204	T-9007G	TEST-GM	T-9084X	SS-A604		
R12750X	R12106HP	T-8086-12	04X205	T-9007L	TEST-E40DB	T-9084Y	SS-F-7		
R12760X	R12108HP	T-8086-13	06X202	T-9082	SS-BB	T-9085	SS-SS-K		
R18305X	R114106AHP	T-8086-14	06X201	T-9083	SOLENOID TESTER	T-9085KC	SS-PCA		
R18506X	R44114HP	T-8086-14B	04X210	T-9083-1	SS-M4R44E-TCC	T-9085K	CASE SS-SC		
R22642X	R22108HP	T-8086-15	06X203	T-9083-2	SS-MCD4E	T-9085KH	SS-MEH		
R26404X	R26108HP	T-8086-16	07X201	T-9083A	SS-4L60/80E	T-9085KL	SS-PC		
R32102AX	R54114AHP	T-8086-17	07X202	T-9083B	SS-MAODE-MCC	T-9085KM	SS-MANUAL		
R32103X	R54106AHP	T-8086-18	07X203	T-9083C	SS-MAXODE-MCC	T-9086	PR231		
R32107X	R54100BHP	T-8086-19	07X204	T-9083D	SS-MRE4-EPC	T-9086A	PR235		
R32108X	R54116BHP	T-8086-20	07X205	T-9083E	SS-4L80E-MCC	T-9087	PR230		
R34304X	R34106HP	T-8086-21	07X206	T-9083F	SS-MAODE-EPC	T-9088	PR233		
R34404AX	R34104AHP	T-8086-22	07X221	T-9083G	SS-MAXODE-EPC	T-9089	PR232		

INTERCHANGE

We Design Solutions

Sonnax® works to develop products that solve root-cause problems, whether it's improving on an OEM design or engineering a solution that isn't available anywhere else. Our success is built on commitment to our customers, consistently delivering innovative products that adhere to strict quality standards; saving time, money and giving you peace of mind.

***Contact your Transtar sales associate for
all your transmission specialty needs.***

Visit www.sonnax.com for complete product listings
and an extensive listing of technical resources.



Automatic Drive • P.O. Box 440 • Bellows Falls, VT 05101
www.sonnax.com • info@sonnax.com